











CHIAVI PER GHIERE E BUSSOLE

PG	454	Chiavi di serraggio per ghiera	
PG	462	Bussole per prigionieri	
PG	467	Estrattori	
PG	471	Bussole per bulloni di sicurezza	

Bussole cromate ed accessori

PG	480	Cassette e guide	
PG	482	Quadro 1/4"	<i>Koken</i>
PG	492	Quadro 1/4"	
PG	517	Quadro 3/8"	<i>Koken</i>
PG	533	Quadro 3/8"	
PG	565	Quadro 1/2"	<i>Koken</i>
PG	581	Quadro 1/2"	
PG	651	Quadro 3/4"	<i>Koken</i>
PG	656	Quadro 3/4"	
PG	681	Quadro 1"	<i>Koken</i>
PG	684	Quadro 1"	

Bussole impact ed accessori

PG	511	Quadro 1/4"	
PG	548	Quadro 3/8"	
PG	619	Quadro 1/2"	
PG	647	Quadro 5/8"	
PG	661	Quadro 3/4"	
PG	685	Quadro 1"	
PG	697	Quadro 1"-1/2"	
PG	702	Quadro 2"-1/2"	
PG	513	Riduzioni	
PG	514	Spine e anelli	

CHIAVI DI SERRAGGIO PER GHIERE AUTOBLOCCANTI



TABELLA MISURE GHIERE AUTOBLOCCANTI CON ANELLO DI NYLON INCORPORATO
NUMERO CAVE 4-6-8

MODELLO "N"
• DENTI ESTERNI
• ACCIAIO SPECIALE BONIFICATO
• A TUBO
• USO A MANO

MODELLO "A"
• DENTI ESTERNI
• ACCIAIO SPECIALE BONIFICATO
• ATTACCO QUADRO
• USO A MANO

MODELLO "S"
• DENTI INTERNI
• ACCIAIO SPECIALE BONIFICATO
• ATTACCO QUADRO
• USO A MACCHINA

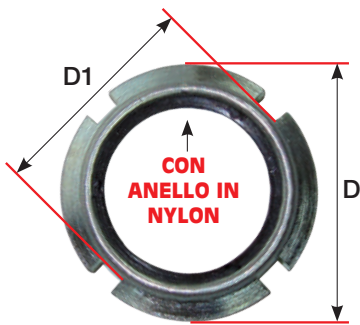
FILETTO mm	D Ø esterno mm	D ₁ Ø interno mm	N° CAVE	GHIERA AUTOBLOCC.	MODELLO "N"				MODELLO "A"				MODELLO "S"					
					articolo	Ø chiave mm	L mm	Euro	articolo	Ø chiave mm	L mm	Euro	articolo	Ø chiave mm	L mm	Euro		
10 x 0,75	18	15	4	4 CAVE	N 10 GU	22	60	12,53	A 10 GU	3/8"	22	60	20,50	S 10 GU	3/8"	30	60	37,32
12 x 1	22	18	4		N 12 GU	25	60	13,21	A 12 GU	3/8"	25	60	21,06	S 12 GU	3/8"	30	60	37,01
15 x 1	25	21	4		N 15 GU	28	60	13,65	A 15 GU	1/2"	28	60	21,65	S 15 GU	1/2"	30	60	40,95
17 x 1	28	24	4		N 17 GU	33	60	14,35	A 17 GU	1/2"	33	60	22,79	S 17 GU	1/2"	35	60	43,28
20 x 1	32	27	4		N 20 GU	35	60	16,63	A 20 GU	1/2"	35	60	25,05	S 20 GU	1/2"	40	60	46,69
25 x 1,5	38	33	4		N 25 GU	43	60	17,31	A 25 GU	1/2"	43	60	25,62	S 25 GU	1/2"	45	60	49,54
30 x 1,5	44	38	4		N 30 GU	48	60	20,48	A 30 GU	1/2"	48	60	26,20	S 30 GU	1/2"	50	60	51,25
35 x 1,5	50	44	4		N 35 GU	55	60	25,20	A 35 GU	3/4"	55	60	27,83	S 35 GU	3/4"	60	60	56,96
40 x 1,5	56	50	4		N 40 GU	59	60	29,40	A 40 GU	3/4"	59	60	30,98	S 40 GU	3/4"	67	60	60,35
45 x 1,5	62	55	4		N 45 GU	67	60	34,13	A 45 GU	3/4"	67	60	34,65	S 45 GU	3/4"	73	60	64,35
50 x 1,5	68	61	4	N 50 GU	73	60	38,85	A 50 GU	3/4"	73	60	39,90	S 50 GU	3/4"	80	60	66,63	
55 x 2	75	68	6	6 CAVE	N 55 GU	80	60	43,05	A 55 GU	3/4"	80	60	47,25	S 55 GU	3/4"	85	60	72,89
60 x 2	80	73	6		N 60 GU	85	60	50,40	A 60 GU	3/4"	85	60	51,45	S 60 GU	3/4"	89	60	77,45
65 x 2	85	77	6		N 65 GU	90	60	53,55	A 65 GU	3/4"	90	60	60,90	S 65 GU	3/4"	95	60	99,65
70 x 2	92	84	6		N 70 GU	97	60	59,85	A 70 GU	3/4"	97	60	68,25	S 70 GU	3/4"	103	60	112,74
75 x 2	98	89	6	N 75 GU	103	60	66,15	A 75 GU	3/4"	103	60	78,75	S 75 GU	3/4"	110	60	128,69	
80 x 2	105	96	8	8 CAVE	N 80 GU	110	60	72,45	A 80 GU	3/4"	110	60	94,50	S 80 GU	3/4"	115	60	139,50
85 x 2	110	100	8		N 85 GU	115	60	81,90	A 85 GU	3/4"	115	60	100,80	S 85 GU	3/4"	125	60	153,74
90 x 2	120	110	8		N 90 GU	125	60	92,40	A 90 GU	3/4"	125	60	115,50	S 90 GU	3/4"	135	60	170,82
95 x 2	125	115	8		N 95 GU	130	60	100,80	A 95 GU	3/4"	130	60	126,00	S 95 GU	3/4"	140	60	193,60
100 x 2	130	120	8		N 100 GU	135	60	115,50	A 100 GU	3/4"	135	60	141,75	S 100 GU	3/4"	150	60	204,98



nota: CONTIENE 11 CHIAVI DEL MOD. "N" PER GHIERE AUTOBLOCCANTI DA 10 X 0,75 FINO A 50 X 1,5

	Descrizione	Euro
articolo NGUC	CASSETTA METALLICA	279,00

nota: CONTIENE 11 CHIAVI DEL MOD. "A" PER GHIERE AUTOBLOCCANTI DA 10 X 0,75 FINO A 50 X 1,5

	Descrizione	Euro
articolo AGUC	CASSETTA METALLICA	312,90

nota: CONTIENE 11 CHIAVI DEL MOD. "S" PER GHIERE AUTOBLOCCANTI DA 10 X 0,75 FINO A 50 X 1,5

	Descrizione	Euro
articolo SGUC	CASSETTA METALLICA	562,57

CHIAVI DI SERRAGGIO PER GHIERE AUTOBLOCCANTI



TABELLA MISURE GHIERE AUTOBLOCCANTI CON ANELLO DI NYLON INCORPORATO NUMERO CAVE 4-6-8

MODELLO "AT"

- DENTI ESTERNI
- ACCIAIO TEMPRATO
- ATTACCO QUADRO CON FORO PER SPINA E ANELLO
- USO A MACCHINA

MODELLO "ST"

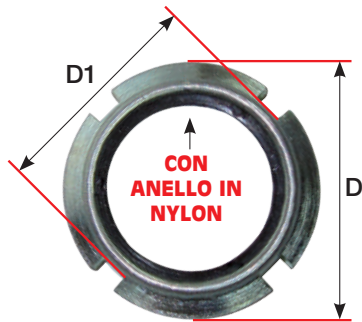
- DENTI INTERNI
- ACCIAIO TEMPRATO
- ATTACCO QUADRO CON FORO PER SPINA E ANELLO
- USO A MACCHINA

FILETTO mm	D Ø esterno mm	D1 Ø interno mm	N° CAVE	GHIERA AUTOBLOCC.	FEFMEC articolo	Ø mm	L mm	Euro	FEFMEC articolo	Ø chiave mm	T mm	L mm	Euro	
10 x 0,75	18	15	4		AT 10 GU	3/8"	50	29,40	ST 10 GU	3/8"	22	44	57	63,00
12 x 1	22	18	4		AT 12 GU	3/8"	50	30,45	ST 12 GU	3/8"	30	44	57	63,00
15 x 1	25	21	4		AT 15 GU	1/2"	55	30,45	ST 15 GU	1/2"	32	60	82	63,00
17 x 1	28	24	4		AT 17 GU	1/2"	55	30,45	ST 17 GU	1/2"	35	60	82	67,20
20 x 1	32	27	4		AT 20 GU	1/2"	55	31,50	ST 20 GU	1/2"	38	60	82	67,20
25 x 1,5	38	33	4	4 CAVE	AT 25 GU	1/2"	55	33,60	ST 25 GU	1/2"	44	60	82	68,25
30 x 1,5	44	38	4		AT 30 GU	1/2"	55	34,65	ST 30 GU	1/2"	52	60	82	78,75
35 x 1,5	50	44	4		AT 35 GU	3/4"	75	36,75	ST 35 GU	1/2"	60	60	82	82,95
40 x 1,5	56	50	4		AT 40 GU	3/4"	75	39,90	ST 40 GU	1/2"	67	60	82	86,10
45 x 1,5	62	55	4		AT 45 GU	3/4"	75	40,95	ST 45 GU	3/4"	73	62	90	126,00
50 x 1,5	68	61	4		AT 50 GU	3/4"	75	47,25	ST 50 GU	3/4"	78	62	90	131,25
55 x 2	75	68	6		AT 55 GU	3/4"	75	57,75	ST 55 GU	3/4"	82	62	90	144,90
60 x 2	80	73	6	6 CAVE	AT 60 GU	3/4"	75	63,00	ST 60 GU	3/4"	88	62	90	147,00
65 x 2	85	77	6		AT 65 GU	3/4"	75	84,00	ST 65 GU	3/4"	96	62	90	157,50
70 x 2	92	84	6		AT 70 GU	1"	110	147,00	ST 70 GU	1"	103	74	110	336,00
75 x 2	98	89	6		AT 75 GU	1"	110	157,50	ST 75 GU	1"	109	74	110	336,00
80 x 2	105	96	8		AT 80 GU	1"	110	168,00	ST 80 GU	1"	115	74	110	367,50
85 x 2	110	100	8		AT 85 GU	1"	110	189,00	ST 85 GU	1"	121	74	110	409,50
90 x 2	120	110	8	8 CAVE	AT 90 GU	1"	110	204,75	ST 90 GU	1"	130	74	110	630,00
95 x 2	125	115	8		AT 95 GU	1"	110	220,50	ST 95 GU	1"	135	74	110	630,00
100 x 2	130	120	8		AT 100 GU	1"	110	262,50	ST 100 GU	1"	145	74	110	735,00
					AT 105 GU	1"	110	304,50						
					AT 110 GU	1"	110	336,00						



CHIAVI DI SERRAGGIO PER GHIERE KM



TABELLA MISURE GHIERE KM
NUMERO CAVE 4

Codice KM	FILETTO mm	D Ø esterno mm	D ₁ Ø interno mm	N° CAVE	GHIERA KM.
0	10 x 0,75	18	14	4	
1	12 x 1	22	18	4	
2	15 x 1	25	21	4	
3	17 x 1	28	24	4	
4	20 x 1	32	28	4	
5	25 x 1,5	38	34	4	
6	30 x 1,5	45	40	4	
7	35 x 1,5	52	48	4	
8	40 x 1,5	58	52	4	
9	45 x 1,5	65	59	4	
10	50 x 1,5	70	65	4	
11	55 x 2	75	67	4	
12	60 x 2	80	73	4	
13	65 x 2	85	79	4	
14	70 x 2	92	85	4	
15	75 x 2	98	90	4	
16	80 x 2	105	95	4	
17	85 x 2	110	102	4	
18	90 x 2	120	108	4	
19	95 x 2	125	116	4	
20	100 x 2	130	120	4	

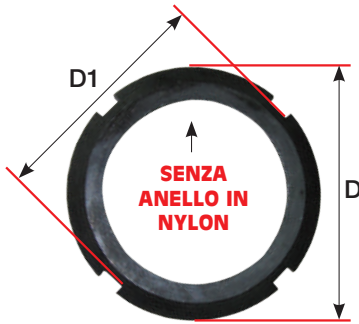

- MODELLO "N"**
- DENTI ESTERNI
 - ACCIAIO SPECIALE BONIFICATO
 - A TUBO
 - USO A MANO

- MODELLO "A"**
- DENTI ESTERNI
 - ACCIAIO SPECIALE BONIFICATO
 - ATTACCO QUADRO
 - USO A MANO

- MODELLO "S"**
- DENTI INTERNI
 - ACCIAIO SPECIALE BONIFICATO
 - ATTACCO QUADRO
 - USO A MACCHINA

articolo	Ø chiave mm	L mm	Euro	articolo	Ø chiave mm	L mm	Euro	articolo	Ø chiave mm	L mm	Euro		
N 10 KM	21	60	12,53	A 10 KM	3/8"	21	60	20,50	S 10 KM	3/8"	25	60	34,17
N 12 KM	25	60	13,21	A 12 KM	3/8"	25	60	21,06	S 12 KM	3/8"	30	60	37,01
N 15 KM	28	60	13,65	A 15 KM	1/2"	28	60	21,65	S 15 KM	1/2"	30	60	40,95
N 17 KM	33	60	14,35	A 17 KM	1/2"	33	60	22,79	S 17 KM	1/2"	35	60	43,28
N 20 KM	40	60	16,63	A 20 KM	1/2"	40	60	25,05	S 20 KM	1/2"	40	60	46,69
N 25 KM	45	60	17,31	A 25 KM	1/2"	45	60	25,62	S 25 KM	1/2"	45	60	49,54
N 30 KM	52	60	20,48	A 30 KM	1/2"	52	60	26,20	S 30 KM	1/2"	55	60	51,25
N 35 KM	58	60	25,20	A 35 KM	3/4"	58	60	27,83	S 35 KM	3/4"	60	60	56,96
N 40 KM	63	60	29,40	A 40 KM	3/4"	63	60	30,98	S 40 KM	3/4"	70	60	60,35
N 45 KM	69	60	34,13	A 45 KM	3/4"	69	60	34,65	S 45 KM	3/4"	75	60	64,35
N 50 KM	73	60	38,85	A 50 KM	3/4"	73	60	39,90	S 50 KM	3/4"	81	60	66,63
N 55 KM	80	60	43,05	A 55 KM	3/4"	80	60	47,25	S 55 KM	3/4"	83	60	72,89
N 60 KM	85	60	50,40	A 60 KM	3/4"	85	60	51,45	S 60 KM	3/4"	89	60	77,45
N 65 KM	90	60	53,55	A 65 KM	3/4"	90	60	60,90	S 65 KM	3/4"	95	60	99,65
N 70 KM	97	60	59,85	A 70 KM	3/4"	97	60	68,25	S 70 KM	3/4"	103	60	112,74
N 75 KM	103	60	66,15	A 75 KM	3/4"	103	60	78,75	S 75 KM	3/4"	111	60	128,69
N 80 KM	110	60	72,45	A 80 KM	3/4"	110	60	94,50	S 80 KM	3/4"	115	60	139,50
N 85 KM	115	60	81,90	A 85 KM	3/4"	115	60	100,80	S 85 KM	3/4"	120	60	153,74
N 90 KM	125	60	92,40	A 90 KM	3/4"	125	60	115,50	S 90 KM	3/4"	125	60	170,82
N 95 KM	130	60	100,80	A 95 KM	3/4"	130	60	126,00	S 95 KM	3/4"	135	60	193,60
N 100 KM	135	60	115,50	A 100 KM	3/4"	135	60	141,75	S 100 KM	3/4"	140	60	204,98



nota: CONTIENE 11 CHIAVI DEL MOD. "N" PER GHIERE KM DA 10 X 0,75 FINO A 50 X 1,5

articolo	Descrizione	Euro
NKMC	CASSETTA METALLICA	279,30

nota: CONTIENE 11 CHIAVI DEL MOD. "A" PER GHIERE KM DA 10 X 0,75 FINO A 50 X 1,5

articolo	Descrizione	Euro
AKMC	CASSETTA METALLICA	312,90

nota: CONTIENE 11 CHIAVI DEL MOD. "S" PER GHIERE KM DA 10 X 0,75 FINO A 50 X 1,5

articolo	Descrizione	Euro
SKMC	CASSETTA METALLICA	562,57

CHIAVI DI SERRAGGIO PER GHIERE KM







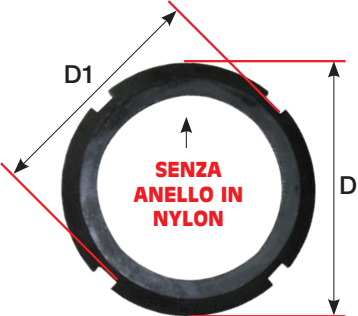

TABELLA MISURE GHIERE KM
NUMERO CAVE 4

Codice KM	FILETTO mm	D Ø esterno mm	D1 Ø interno mm	N° CAVE	GHIERA KM.
0	10 x 0,75	18	14	4	
1	12 x 1	22	18	4	
2	15 x 1	25	21	4	
3	17 x 1	28	24	4	
4	20 x 1	32	28	4	
5	25 x 1,5	38	34	4	
6	30 x 1,5	45	40	4	
7	35 x 1,5	52	48	4	
8	40 x 1,5	58	52	4	
9	45 x 1,5	65	59	4	
10	50 x 1,5	70	65	4	
11	55 x 2	75	67	4	
12	60 x 2	80	73	4	
13	65 x 2	85	79	4	
14	70 x 2	92	85	4	
15	75 x 2	98	90	4	
16	80 x 2	105	95	4	
17	85 x 2	110	102	4	
18	90 x 2	120	108	4	
19	95 x 2	125	116	4	
20	100 x 2	130	120	4	
21	105 x 2	140	126	4	
22	110 x 2	145	133	4	



4 CAVE

MODELLO "AT"

- DENTI ESTERNI
- ACCIAIO TEMPRATO
- ATTACCO QUADRO CON FORO PER SPINA E ANELLO
- USO A MACCHINA

articolo	Ø	L mm	Euro
AT 10 KM	3/8"	50	29,40
AT 12 KM	3/8"	50	30,45
AT 15 KM	1/2"	55	30,45
AT 17 KM	1/2"	55	30,45
AT 20 KM	1/2"	55	31,50
AT 25 KM	1/2"	55	33,60
AT 30 KM	1/2"	55	34,65
AT 35 KM	3/4"	75	36,75
AT 40 KM	3/4"	75	39,90
AT 45 KM	3/4"	75	40,95
AT 50 KM	3/4"	75	47,25
AT 55 KM	3/4"	75	57,75
AT 60 KM	3/4"	75	63,00
AT 65 KM	3/4"	75	84,00
AT 70 KM	1"	110	147,00
AT 75 KM	1"	110	157,50
AT 80 KM	1"	110	168,00
AT 85 KM	1"	110	189,00
AT 90 KM	1"	110	204,75
AT 95 KM	1"	110	220,50
AT 100 KM	1"	110	262,50
AT 105 KM	1"	110	304,50
AT 110 KM	1"	110	336,00

MODELLO "ST"

- DENTI INTERNI
- ACCIAIO TEMPRATO
- ATTACCO QUADRO CON FORO PER SPINA E ANELLO
- USO A MACCHINA

articolo	Ø chiave mm	T mm	L mm	Euro	
ST 10 KM	3/8"	22	44	57	52,50
ST 12 KM	3/8"	30	44	57	52,50
ST 15 KM	1/2"	32	60	82	52,50
ST 17 KM	1/2"	35	60	82	56,70
ST 20 KM	1/2"	38	60	82	56,70
ST 25 KM	1/2"	44	60	82	61,95
ST 30 KM	1/2"	52	60	82	68,25
ST 35 KM	1/2"	60	60	82	71,40
ST 40 KM	1/2"	67	60	82	75,60
ST 45 KM	3/4"	73	62	90	110,25
ST 50 KM	3/4"	78	62	90	113,40
ST 55 KM	3/4"	82	62	90	117,60
ST 60 KM	3/4"	88	62	90	121,80
ST 65 KM	3/4"	96	62	90	124,95
ST 70 KM	1"	103	74	110	287,70
ST 75 KM	1"	109	74	110	287,70
ST 80 KM	1"	115	74	110	294,00
ST 85 KM	1"	121	74	110	351,75
ST 90 KM	1"	130	74	110	430,50
ST 95 KM	1"	135	74	110	502,95
ST 100 KM	1"	145	74	110	619,50

CHIAVI DI SERRAGGIO PER GHIERE KMT





TABELLA MISURE GHIERE KMT
(CON GRANI DI FISSAGGIO)
NUMERO CAVE 4

Codice KMT	FILETTO D mm	S mm	B mm	h mm	N° CAVE
6	30X1,5	46	5	20	4
7	35X1,5	50	5	22	4
8	40X1,5	60	6	22	4
9	45X1,5	65	6	22	4
10	50X1,5	70	7	25	4
11	55X2	80	7	25	4
12	60X2	85	8	26	4
13	65X2	90	8	28	4
14	70X2	95	8	28	4
15	75X2	100	8	28	4

MODELLO "KMT"

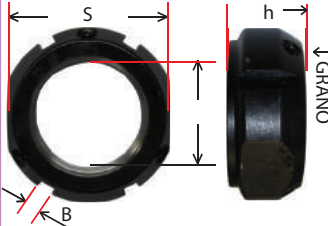
- DENTI INTERNI
- ACCIAIO SPECIALE BONIFICATO
- ATTACCO QUADRO

articolo	Ø	L mm	Euro
KMT 30	3/4"	80	51,45
KMT 35	3/4"	80	60,90
KMT 40	3/4"	80	74,55
KMT 45	3/4"	80	89,25
KMT 50	3/4"	80	102,90
KMT 55	3/4"	80	123,90
KMT 60	3/4"	80	136,50
KMT 65	3/4"	80	152,25
KMT 70	3/4"	80	168,00
KMT 75	3/4"	80	189,00



CHIAVI PER GHIERE

9 CHIAVI PER GHIERE

CHIAVI PER GHIERE



BGS articolo	DESCRIZIONE	Euro
BGS 8265	SET 11 PEZZI, CHIAVI DI SERRAGGIO PER GHIERE, DENTI ESTERNI	316,25

CARATTERISTICHE

- attacco quadro: 1/2"
- lunghezza: 60 mm
- Ø esterno x Ø interno x larghezza dente:
 - 22,0 mm x 15,5 mm x 2,6 mm (KM 0)
 - 26,0 mm x 18,5 mm x 2,6 mm (KM 1)
 - 30,0 mm x 21,5 mm x 3,5 mm (KM 2)
 - 33,0 mm x 25,0 mm x 3,8 mm (KM 3)
 - 37,0 mm x 27,5 mm x 4,0 mm
 - 44,0 mm x 33,5 mm x 4,5 mm
 - 50,0 mm x 38,5 mm x 4,7 mm
 - 56,0 mm x 44,5 mm x 4,7 mm
 - 63,0 mm x 50,5 mm x 5,7 mm
 - 69,0 mm x 55,5 mm x 5,5 mm (KM 8)
 - 75,0 mm x 61,5 mm x 5,5 mm (KM 9)

RICAMBI

BGS articolo	DESCRIZIONE	Euro
NEW BGS 8265-1	CHIAVE Ø EST. 22 MM	24,23
NEW BGS 8265-2	CHIAVE Ø EST. 26 MM	24,23
NEW BGS 8265-3	CHIAVE Ø EST. 30 MM	24,23
NEW BGS 8265-4	CHIAVE Ø EST. 33 MM	25,50
NEW BGS 8265-5	CHIAVE Ø EST. 37 MM	26,78
NEW BGS 8265-6	CHIAVE Ø EST. 44 MM	25,50
NEW BGS 8265-7	CHIAVE Ø EST. 50 MM	25,50
NEW BGS 8265-8	CHIAVE Ø EST. 56 MM	26,78
NEW BGS 8265-9	CHIAVE Ø EST. 63 MM	29,33
NEW BGS 8265-10	CHIAVE Ø EST. 69 MM	33,15
NEW BGS 8265-11	CHIAVE Ø EST. 75 MM	34,43



BGS articolo	DESCRIZIONE	Euro
BGS 9385	SET 13 PEZZI, CHIAVI DI SERRAGGIO PER GHIERE KM 0 - KM 12, DENTI INTERNI	403,75

CARATTERISTICHE

- per ghiera KM 0-1-2-3-4-5-6-7-8-9-10-11-12
- attacco quadro: 1/2"
- lunghezza: 60 mm

RICAMBI

BGS articolo	DESCRIZIONE	Euro
NEW BGS 8266-1	CHIAVE Ø EST. 20.0 MM	36,98
NEW BGS 8266-2	CHIAVE Ø EST. 23.5 MM	40,80
NEW BGS 8266-3	CHIAVE Ø EST. 26.5 MM	42,08
NEW BGS 8266-4	CHIAVE Ø EST. 29.5 MM	22,95
NEW BGS 8266-5	CHIAVE Ø EST. 34.5 MM	24,23
NEW BGS 8266-6	CHIAVE Ø EST. 40.5 MM	26,78
NEW BGS 8266-7	CHIAVE Ø EST. 46.5 MM	34,43
NEW BGS 8266-8	CHIAVE Ø EST. 59.5 MM	42,08
NEW BGS 8266-9	CHIAVE Ø EST. 65.8 MM	48,45
NEW BGS 8266-10	CHIAVE Ø EST. 71.8 MM	51,00



BGS articolo	DESCRIZIONE	Euro
BGS 8542	SET 8 PEZZI, CHIAVI A SETTORE SNODATE 35 - 120 MM	131,25

CARATTERISTICHE

- adatto per DIN 1804 e DIN 981
- misure Ø: 19-90, 35-60, 60-90, 90-120 mm
- 3 ganci con nasello tondo intercambiabili
- 6 naselli tondi intercambiabili nelle misure:
 - Ø 4 mm x lungh. 4 mm
 - Ø 5 mm x lungh. 4 mm
 - Ø 6 mm x lungh. 4 mm
 - Ø 6 mm x lungh. 8 mm
 - Ø 8 mm x lungh. 8 mm



CHIAVI A SETTORE CON NASELLO QUADRO TEMPRATE ZIN CATE DIN 1810

BGS articolo	mm	L mm	Euro
282-2528	25 x 28	135	8,00
282-3032	30 x 32	135	8,00
282-3436	34 x 36	170	8,00
282-4042	40 x 42	170	8,40
282-4550	45 x 50	205	9,98
282-5055	50 x 55	205	11,03
282-5862	58 x 62	240	12,08
282-6875	68 x 75	240	14,00
282-8090	80 x 90	280	15,75
282-95100	95 x 100	280	17,85
282-110115	110 x 115	320	26,25
282-120130	120 x 130	330	29,40



BGS articolo	DESCRIZIONE	Euro
BGS 1463	CHIAVE A SETTORE, REGOLABILE, 180 MM	12,62

CARATTERISTICHE

- lunghezza braccio 172 mm (giunto centrale - cento spina)
- apertura minima 11 mm
- estremità anteriore sfasata da 11 mm
- diametro spine 4 mm
- spine rivettate

BGS articolo	DESCRIZIONE	Euro
BGS 1225	CHIAVE A SETTORE, DIN 1804	11,96

CARATTERISTICHE

- lunghezza 280 mm, ganascia da 75 mm
- per lavorare su ghiera



BGS articolo	DESCRIZIONE	Euro
BGS 1226	CHIAVE A SETTORE SNODATA, ACCIAIO SPECIALE	19,25

CARATTERISTICHE

- acciaio speciale
- finitura nera
- per ghiera (DIN 1804) e per la regolazione dei cuscinetti
- portata della ganascia: 35-60 mm
- lunghezza totale 175 mm

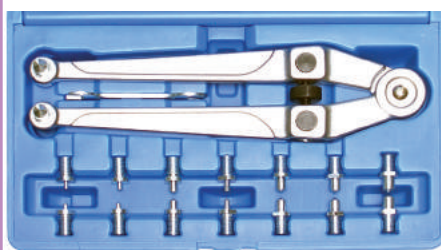

BGS 1464-2,5 BGS 1464-3



BGS articolo	DESCRIZIONE	Euro
BGS 1464	SET CHIAVE A SETTORE REGOLABILE	164,88

CARATTERISTICHE

- chiave a settore, regolabile, lunghezza: 245 mm
- acciaio speciale, temprato, zincato
- con 8 coppie di spine intercambiabili
- una sola chiave per tutti le spine standard
- Ø spine: 2,5 - 3 - 4 - 5 - 6 - 7 - 8 - 9 mm
- apertura 102 mm

RICAMBI

BGS articolo	DESCRIZIONE	Euro
BGS 1464-2,5	COPPIA PIN DA 2,5 MM, DA BGS 1464	7,65
BGS 1464-3	COPPIA PIN DA 3 MM, DA BGS 1464	7,65
BGS 1464-4	COPPIA PIN DA 4 MM, DA BGS 1464	7,65
BGS 1464-5	COPPIA PIN DA 5 MM, DA BGS 1464	7,65

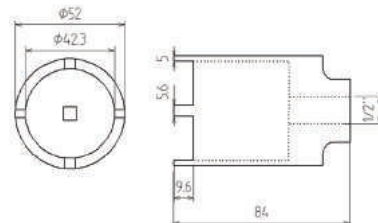

BGS articolo	DESCRIZIONE	Euro
BGS 5422	CHIAVE CON DENTI ESTERNI PER SNODO PORTANTE, CITROËN / PEUGEOT	32,64

CARATTERISTICHE

- per svitare e serrare snodi portanti
- idonea per i modelli:
 - Citroen BX (9/82-94), C5, Xantia
 - Peugeot 305 (7/82-90), 405 (6/87-), 406, 605, 607, ecc...



BGS articolo	DESCRIZIONE	Euro
BGS 8268	CHIAVE SPECIALE PER GHIERE, MB ACTROS, 105 - 125 MM	272,50

CARATTERISTICHE

- per asse posteriore Mercedes Benz Actros, HL/HL 8 (Hypoid) etc.
- conforme DIN 3121 / ISO 1174
- grande resistenza in chiusura e allentamento
- diametro interno: 105 mm
- diametro esterno: 125 mm
- lunghezza: 182 mm
- diametro perno: 115 mm
- 6 denti
- larghezza denti: 10 mm
- peso: 2.6 kg

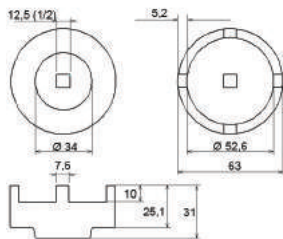

BGS articolo	DESCRIZIONE	Euro
BGS 8575	CHIAVE PER GIUNTI PER MERCEDES-BENZ CLASSE M	45,00

CARATTERISTICHE

- per giunti sferici sospensioni sugli assi anteriore e posteriore delle Mercedes-Benz Classe M W163 e W164
- tipo piatto
- attacco: quadro femmina da 1/2"

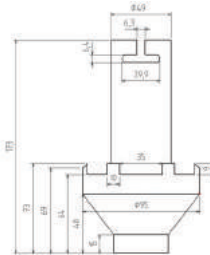

Mercedes-Benz



BGS articolo	DESCRIZIONE	Euro
BGS 8269	CHIAVE SPECIALE PER GHIERE, PER MB ATEGO, 80 - 95 MM	236,25

CARATTERISTICHE

- per asse posteriore Mercedes Benz Atego rear axle, Vitaro 814, MAN, etc.
- conforme DIN 3121 / ISO 1174
- grande resistenza in chiusura e allentamento
- diametro interno: 80 mm
- diametro esterno: 95 mm
- locating tube diameter: 49 mm
- lunghezza: 185 mm
- diametro perno: 87 mm
- 6 denti
- larghezza denti: 10 mm
- peso: 2.6 kg

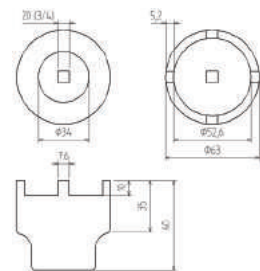

BGS articolo	DESCRIZIONE	Euro
BGS 5420	CHIAVE PER GHIERE MERCEDES CLASSE M ATTACCO 1/2"	66,25

CARATTERISTICHE

- per Mercedes Benz ML W163 fino a giugno 2005 e W164 dal 2005
- per la sostituzione dei giunti sferici sospensioni su assi anteriori e posteriori
- facilita allentamento e serraggio controdadi dei giunti delle sospensioni con coppia corretta
- per i giunti delle sospensioni inferiori su assi anteriore e posteriore
- attacco 3/4 "



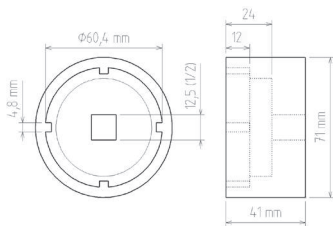

BGS articolo	DESCRIZIONE	Euro
BGS 5423	BUSSOLA PER DADO SCANALATO PER FORD TRANSIT CON ASSE TIPO 34	38,00

CARATTERISTICHE

- attacco 1/2"

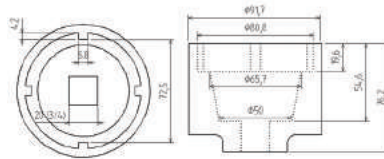

BGS articolo	DESCRIZIONE	Euro
BGS 5421	BUSSOLA ALBERO PRINCIPALE ANTERIORE FRIZIONE 72/80 MM ATTACCO 3/4"	231,25

CARATTERISTICHE

- per Scania
- per la rimozione della flangia dell'albero di trasmissione principale
- attacco 3/4"

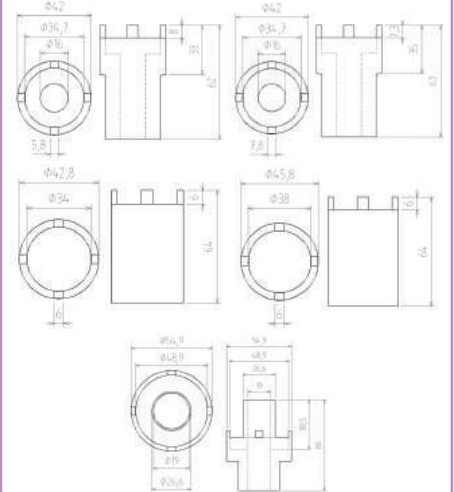

BGS articolo	DESCRIZIONE	Euro
BGS 67220	SET 5 PEZZI, CHIAVI PER GHIERE	156,25

CARATTERISTICHE

- idonee per differenziale, trasmissione e flangia asse posteriore Mercedes
- per Mercedes serie 107 - 114 - 115 - 116 - 126 ..
- consente allentamento e serraggio per mezzo di una chiave dinamometrica
- attacco 1/2"



NEW

BGS 9373-12 BGS 9373-13



BGS 9373-14 BGS 9373-16



BGS articolo	DESCRIZIONE	Euro
BGS 9373	SET 7 PEZZI, PER PULIZIA PRIGIONIERI	87,21

CARATTERISTICHE

- per una rapida pulizia dei prigionieri
- adattatore rapido con attacco quadro da 1/2"
- adattatore quadro 1/2" - esagonale 1/4", per poter utilizzare le spazzole con trapano a batteria
- comprende 5 spazzole per le seguenti dimensioni:
 - 12 mm (7/16")
 - 13 mm (1/2")
 - 14 mm (9/16")
 - 16 mm (5/8")
 - 22 mm (7/8")

RICAMBI

BGS articolo	DESCRIZIONE	Euro
BGS 9373-12	SPAZZOLA 12 MM (7/16")	12,11
BGS 9373-13	SPAZZOLA 13 MM (1/2")	12,11
BGS 9373-14	SPAZZOLA 14 MM (9/16")	12,11
BGS 9373-16	SPAZZOLA 16 MM (5/8")	12,11



ESAGONO 12 mm. FIAM-OBER

BUSSOLA FILETTATA AVVITA PRIGIONIERI CON ESTREMITÀ INTERNA DELLA BUSSELLA SFERICA

attacco: 12 mm FIAM-OBER
impronta: Ø FILETTO

articolo	Ø Filetto	L mm	📦	Euro
BP 120031	M 3X0,5	40	1	12,60
BP 120041	M 4X0,7	40	1	12,60
BP 120051	M 5X0,8	40	1	12,60
BP 120061	M 6X1,0	40	1	12,60
BP 120081	M 8X1,25	40	1	12,60
BP 120181	M 8X1	40	1	12,60
BP 120125	M 10X1,25	40	1	12,60
BP 120150	M 10X1,5	40	1	12,60
BP 121125	M 12X1,25	40	1	12,60
BP 120175	M 12X1,75	40	1	12,60
BP 120145	M 14X1,50	40	1	12,60
BP 120142	M 14X2,00	40	1	13,65
BP 120162	M 16X2,00	40	1	15,75
BP 120185	M 18X2,50	40	1	31,50



ESAGONO 1/4" E

CHIAVE AVVITA PRIGIONIERI - BARRE FILETTATE ESTREMITÀ INTERNA DELLA BUSSELLA SFERICA

attacco: DIN 3126, E 6,35
impronta: Ø FILETTO

articolo	Ø Filetto	L mm	📦	Euro
AP 3	M 3x0,5	60	1	12,60
AP 4	M 4x0,7	60	1	12,60
AP 5	M 5x0,8	60	1	12,60
AP 6	M 6x1,0	60	1	12,60
AP 8	M 8x1,25	60	1	15,23
AP 10	M 10x1,50	60	1	17,33

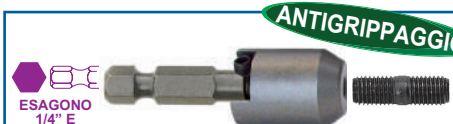

ESAGONO 1/4" E

CHIAVE AVVITA PRIGIONIERI CON SGANCIO RAPIDO ANTIGRIPPAGGIO

attacco: DIN 3126, E 6,35
impronta: Ø FILETTO

articolo	Ø Filetto	L mm	📦	Euro
AP 1/4" SP 6	M 6x1	60	1	47,25
AP 1/4" SP 8	M 8x1,25	60	1	47,25



ESAGONO 12 mm. FIAM-OBER

CHIAVE AVVITA PRIGIONIERI CON SGANCIO RAPIDO ANTIGRIPPAGGIO

attacco: 12 mm FIAM-OBER
impronta: Ø FILETTO

articolo	Ø Filetto	L mm	📦	Euro
CP 2120061	M 6x1	60	1	47,25
CP 2120081	M 8x1,25	60	1	47,25
CP 2120150	M 10x1,5	60	1	47,25
CP 2120175	M 12x1,75	60	1	47,25



BUSSOLE FILETTATE AVVITA PRIGIONIERI A SGANCIO RAPIDO ANTIGRIPPAGGIO

attacco: 3/8"
impronta: FILETTO

articolo	mm	L mm	📦	Euro
900659	M 6 x 1	59	1	99,90
900859	M 8 x 1,25	59	1	99,90
901059	M 10 x 1,5	59	1	99,90

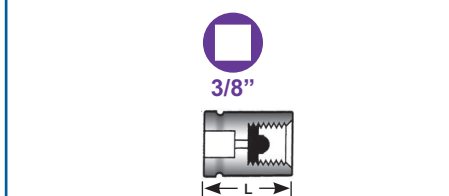

BUSSOLE FILETTATE AVVITA PRIGIONIERI + SFERA INTERNA

attacco: 3/8"
impronta: FILETTO

articolo	mm	L mm	📦	Euro
BA 5	M 5 x 0,8	50	1	16,80
BA 6	M 6 x 1	50	1	16,80
BA 7	M 7 x 1	50	1	16,80
BA 8	M 8 x 1,25	50	1	16,80
BA 10	M 10 x 1,5	50	1	16,80
BA 10125	M 10 x 1,25	50	1	16,80



BUSSOLE FILETTATE AVVITA PRIGIONIERI A SGANCIO RAPIDO ANTIGRIPPAGGIO

attacco: 1/2"
impronta: FILETTO

articolo	mm	L mm		Euro
901800	M 8 x 1,25	75	1	120,00
902100	M 10 x 1,5	75	1	120,00
902200	M 12 x 1,75	75	1	120,00



BUSSOLE FILETTATE AVVITA PRIGIONIERI BB 6-8-10-12-14

attacco: 1/2"
impronta: FILETTO

articolo	Descrizione		Euro
521052	CASSETTA METALLICA 5 PEZZI	1	97,61



BUSSOLE FILETTATE AVVITA PRIGIONIERI + SFERA INTERNA

attacco: 1/2"
impronta: FILETTO

articolo	mm	L mm		Euro
BB 6	M 6 x 1	55	1	18,90
BB 7	M 7 x 1	55	1	18,90
BB 8	M 8 x 1,25	55	1	18,90
BB 10	M 10 x 1,5	55	1	18,90
BB 12	M 12 x 1,75	55	1	18,90
BB 14	M 14 x 2	55	1	29,40
BB 16	M 16 x 2	75	1	36,75
BB 18	M 18 x 2,5	75	1	47,25
BB 20	M 20 x 2,5	75	1	52,50
BB 81000	M 8 x 1	55	1	18,90
BB 10125	M 10 x 1,25	55	1	18,90
BB 12125	M 12 x 1,25	55	1	18,90
BB 12150	M 12 x 1,5	55	1	18,90
BB 14150	M 14 x 1,5	55	1	29,40
BB 16150	M 16 x 1,5	75	1	36,75
BB 18150	M 18 x 1,5	75	1	47,25
BB 20150	M 20 x 1,5	75	1	52,50
BB 22150	M 22 x 1,5	75	1	52,50
BB 34100	3/4" x 10 UNC	75	1	52,50
BB 58100	5/8" x 11 UNC	75	1	52,50
BB 12130	1/2" x 13 UNC	75	1	52,50



BUSSOLE FILETTATE AVVITA PRIGIONIERI + SFERA INTERNA

attacco: 3/4"
impronta: FILETTO

articolo	mm	L mm		Euro
BC 16150	M 16 x 1,5	100	1	68,25
BC 16200	M 16 x 2,0	100	1	68,25
BC 18150	M 18 x 1,5	100	1	68,25
BC 18250	M 18 x 2,5	100	1	68,25
BC 20150	M 20 x 1,5	100	1	68,25
BC 20250	M 20 x 2,5	100	1	68,25
BC 22250	M 22 x 2,5	100	1	68,25
BC 24300	M 24 x 3,0	100	1	68,25
BC 27300	M 27 x 3,0	100	1	68,25
BC 30350	M 30 x 3,5	100	1	73,50
BC 33350	M 33 x 3,5	100	1	73,50
BC 36400	M 36 x 4,0	100	1	94,50



BUSSOLA AVVITA PRIGIONIERI ATTACCO 3/8" POWER IMPACT

articolo	mm	D mm	L mm		Euro
13103M-5x0.8	5x0.8	9.5	32	1	15,37
13103M-6x1.0	6x1.0	10.8	32	1	15,37
13103M-7x1.0	7x1.0	12.5	32	1	15,37
13103M-8x1.25	8x1.25	13.5	35	1	15,37
13103M-10x1.25	10x1.25	15.8	35	1	15,37
13103M-10x1.5	10x1.5	15.8	35	1	15,84

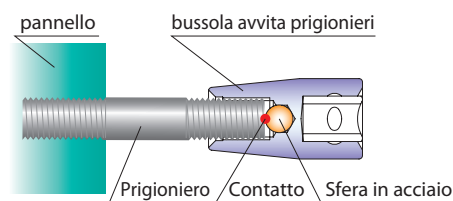

Bussola speciale per avvitare i prigionieri. La sfera di acciaio all'interno della bussola impedisce il blocco del prigioniero. Dopo l'avvitamento girare in senso antiorario per rimuovere la bussola.



BUSSOLA AVVITA PRIGIONIERI ATTACCO 1/2" POWER IMPACT

articolo	mm	D mm	L mm		Euro
14103M-6x1.0	6x1.0	12	38	1	16,14
14103M-7x1.0	7x1.0	13.2	38	1	16,14
14103M-8x1.25	8x1.25	14.5	38	1	16,14
14103M-10x1.25	10x1.25	17	44	1	19,55
14103M-10x1.5	10x1.5	17	44	1	19,55
14103M-12x1.25	12x1.25	19.5	44	1	19,55
14103M-12x1.75	12x1.75	19.5	44	1	19,55
14103M-14x1.5	14x1.5	22	50	1	27,12
14103M-14x2.0	14x2.0	22	50	1	27,12

BUSSOLE PER PRIGIONIERI

9 BUSSOLE PER PRIGIONIERI

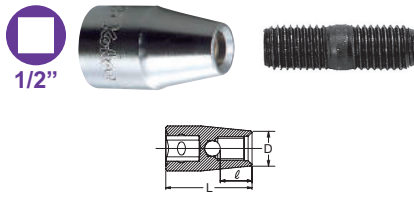

**BUSSOLA AVVITA PRIGIONIERI
ATTACCO 1/2"**

Koken articolo	mm	D mm	L mm		Euro
4103M-6x1.0	6x1.0	10.3	37	1	17,55
4103M-7x1.0	7x1.0	11.5	37	1	17,55
4103M-8x1.25	8x1.25	13.2	37	1	17,55
4103M-10x1.25	10x1.25	15.3	44	1	20,32
4103M-10x1.5	10x1.5	15.3	44	1	20,32
4103M-12x1.25	12x1.25	17.8	44	1	20,32
4103M-12x1.75	12x1.75	17.8	44	1	20,32



Koken articolo	DESCRIZIONE	Euro
4203M	Set 4 pezzi bussole avvita prigionieri	84,87

RICAMBI

BUSSOLE	4103M	6(1.0), 8(1.25), 10(1.5), 12(1.75)
---------	-------	------------------------------------



PASSO FINE

Koken articolo	DESCRIZIONE	Euro
4203MF	Set 4 pezzi bussole avvita prigionieri	84,87

RICAMBI

BUSSOLE	4103M	6(1.0), 8(1.25), 10(1.25), 12(1.25)
---------	-------	-------------------------------------

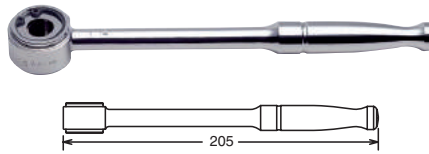

**ESTRATTORE PER PRIGIONIERI
CON IMPUGNATURA**

Koken articolo	mm	D mm	L mm		Euro
141P-6	6	28	205	1	69,91
141P-8	8	28	205	1	69,91
141P-10	10	32	205	1	69,91
141P-12	12	32	205	1	71,25



**ESTRATTORE PER PRIGIONIERI
CON IMPUGNATURA**

Koken articolo	mm	D mm	L mm		Euro
141S-6	6	28	120	1	56,84
141S-8	8	28	120	1	56,84
141S-10	10	32	120	1	56,84
141S-12	12	32	120	1	56,84

141-6	6	28	205	1	61,99
141-8	8	28	205	1	61,99
141-10	10	32	205	1	61,99
141-12	12	32	205	1	61,99

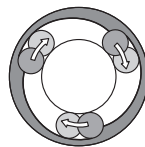

Il sistema a tre rulli protegge i filetti dal danneggiamento.



FERMEC articolo	DESCRIZIONE	Euro
1201	Cassetta in metallo 4 Pz. 240 x 100 x h32	227,65

RICAMBI

141S	6, 8, 10, 12
------	--------------

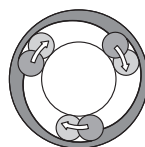

Il sistema a tre rulli protegge i filetti dal danneggiamento.



**ESTRATTORE PER PRIGIONIERI
AD ECCENTRICO ATTACCO 1/2"**

Koken articolo	tolleranza min	max	L mm		Euro
4104	Ø 6	Ø 19	56	1	107,42



BGS articolo	DESCRIZIONE	Euro
BGS 8799	ESTRATTORE PRIGIONIERI, 6-19 MM	22,82

CARATTERISTICHE

- per allentare i perni prigionieri inceppati
- idoneo per allentamento e serraggio
- idoneo per perni di diametro da 6 a 19 mm
- rotella di serraggio zigrinata e temprata



BGS articolo	DESCRIZIONE	Euro
BGS 1903	ESTRATTORE PRIGIONIERI	26,78

CARATTERISTICHE

- idoneo per prigionieri danneggiati o spezzati di diametro da 6,3 a 14 mm (1/4" - 9/16")
- azione mediante bussola da 19 mm



1/2"

PRO+ CV

BGS articolo	DESCRIZIONE	Euro
BGS 8576	MANDRINO PER PRIGIONIERI, 6-12 MM	45,14

CARATTERISTICHE

- permette una rapida installazione e rimozione dei prigionieri
- mandrino per prigionieri da 6 - 12 mm
- mandrino esagonale da 36 mm
- attacco: quadro femmina da 1/2", esag. 24 mm



1/2"

PRO+ CV

BGS articolo	DESCRIZIONE	Euro
BGS 1882	SET 4 PEZZI, ESTRATTORI PRIGIONIERI A RULLI	58,40

CARATTERISTICHE

- attacco quadro 1/2"
- dimensioni: 6-8-10-12 mm



1/2"

PRO+ CV

BGS articolo	DESCRIZIONE	Euro
BGS 65505	SET 5 PEZZI, ESTRATTORI PRIGIONIERI A RULLI	70,64

CARATTERISTICHE

- contenuto:
 - 1 chiave a cricchetto reversibile a doppio anello 14 x 17 mm
 - 4 estrattori prigionieri 6, 8, 10 e 12 mm



1/2"

PRO+ CV

ESTRATTORI PER PRIGIONIERI A RULLI

BGS articolo	DESCRIZIONE	Euro
BGS 65515-5	NEW 5 MM	16,58
BGS 1883	6 MM	14,38
BGS 65515-7	7 MM	17,34
BGS 1884	8 MM	14,66
BGS 65515-9	NEW 9 MM	17,85
BGS 1885	10 MM	15,81
BGS 65515-10.5	NEW 10.5 MM	19,13
BGS 65515-11	NEW 11 MM	21,68
BGS 1886	12 MM	15,81
BGS 65515-14	NEW 14 MM	26,01
BGS 65515-16	NEW 16 MM	26,78

CARATTERISTICHE

- lunghezza 60 mm
- coppia massima 20 Nm
- con attacco quadro femmina 1/2" ed esagono di manovra



1/2"

PRO+ CV

BGS articolo	DESCRIZIONE	Euro
BGS 65515	SET 11 PEZZI, ESTRATTORI A RULLI PER PRIGIONIERI A RULLI	208,75

CARATTERISTICHE

- 5 - 6 - 7 - 8 - 9 - 10 - 10,5 - 11 - 12 - 14 e 16 mm
- tutti gli estrattori con attacco quadro femmina 1/2" ed esagono esterno
- coppia massima 20 Nm



BUSSOLA ESTRATTORE	2 mm	3 mm	4 mm	6 mm	8 mm	10 mm	12 mm	14 mm	16 mm
FILETTO mm	M5	M6	M8	M10-M12	M14-M16	M18-M20	M22-M24	M27-M30	M33
PUNTA TRAP. mm	2,4-2,6	3,2-3,5	4,2-4,5	6,2-6,5	8,2-8,5	10,2-10,5	12,2-12,5	14,2-14,5	16,2-16,5

BUSSOLE PER PRIGIONIERI

9 BUSSOLE PER PRIGIONIERI

1/2"

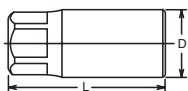

**ESTRATTORE PER PRIGIONIERI A RULLI
ATTACCO 1/2"**

Kokon articolo	mm	D mm	L mm		Euro
4100M-5	5.0	24	65	1	25,16
4100M-6	6.0	24	65	1	25,16
4100M-7	7.0	24	65	1	25,16
4100M-8	8.0	24	65	1	25,16
4100M-9	9.0	28	75	1	28,27
4100M-10	10.0	28	75	1	28,27
4100M-10.5	10.5	28	75	1	28,27
4100M-11	11.0	28	75	1	28,27
4100M-12	12.0	28	75	1	28,27
4100M-14	14.0	34	75	1	31,65
4100M-16	16.0	34	75	1	36,11

POLLICI

4100A-1/4	1/4	24	65	1	27,12
4100A-5/16	5/16	24	65	1	27,12
4100A-3/8	3/8	28	75	1	30,47
4100A-7/16	7/16	28	75	1	30,47
4100A-1/2	1/2	28	75	1	33,14
4100A-9/16	9/16	34	75	1	34,10
4100A-5/8	5/8	34	75	1	38,89

**GLI ART. 4100M-16 E 4100A-5/8 NON HANNO
ATTACCO QUADRO DA 1/2" MA SOLO
ATTACCO ESAGONALE DA 27 Mm**

Tolleranze Estrattori 4100M-4100A

4100M mm		4100A pollici mm	
5	4.7 - 5	1/4	6 - 6.4
6	5.6 - 6	5/16	7.6 - 8
7	6.6 - 7	3/8	9 - 9.6
8	7.6 - 8	7/16	10.5 - 11.1
9	8.4 - 9	1/2	12.1 - 12.7
10	9.4 - 10	9/16	13.5 - 14.3
10.5	9.9 - 10.5	5/8	15.2 - 16
11	10.4 - 11		
12	11.4 - 12		
14	13.2 - 14		
16	15.2 - 16		

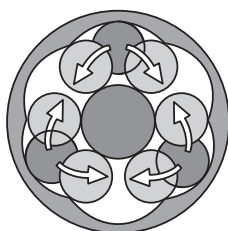

Kokon articolo	DESCRIZIONE	Euro
4211M	Cassetta in metallo 4 Pz. 220 x 85 x h45	114,90
RICAMBI		
4100M	6, 8, 10, 12	

POLLICI



Kokon articolo	DESCRIZIONE	Euro
4211A	Cassetta in metallo 4 Pz. 220 x 85 x h45	122,90
RICAMBI		
4100A	1/4, 5/16, 3/8, 1/2	



Kokon articolo	DESCRIZIONE	Euro
4214M	Cassetta in metallo 5 Pz. 220 x 85 x h45	147,76
RICAMBI		
4100M	6, 8, 10, 12, 14	

Tolleranze Estrattori 14100M-14100A

14100M mm	14100A pollici mm
6	5.6 - 6
7	6.6 - 7
8	7.6 - 8
9	8.4 - 9
10	9.4 - 10
12	11.4 - 12

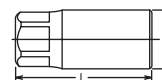

ESTRATTORE PER PRIGIONIERI A RULLI

Kokon articolo	mm	ATT.	D mm	L mm	Euro
6100M-18	18	3/4"	48	100	190,05
6100M-20	20	3/4"	48	100	190,05
6100M-22	22	36 mm	48	100	217,99
6100M-24	24	36 mm	48	100	217,99
6100M-27	27	46 mm	63	125	273,74
6100M-28	28	46 mm	63	125	275,58
6100M-29	29	46 mm	63	125	275,58
6100M-30	30	46 mm	63	125	275,58

Tolleranze Estrattori 6100M

6100M mm	
18	16.9 - 18
20	18.8 - 20
22	20.8 - 22
24	22.7 - 24
27	25.7 - 27
28	26.7 - 28
29	27.6 - 29
30	28.6 - 30



**ESTRATTORE PER PRIGIONIERI A RULLI
ATTACCO 1/2" IMPACT**

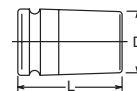

Kokon articolo	mm	D mm	L mm		Euro
14100M-6	6	24	48	1	32,07
14100M-7	7	24	48	1	32,07
14100M-8	8	24	48	1	32,07
14100M-9	9	28	48	1	33,77
14100M-10	10	28	48	1	33,77
14100M-12	12	28	48	1	33,77

POLLICI

14100A-1/4	1/4"	24	48	1	34,60
14100A-5/16	5/16"	24	48	1	34,60
14100A-3/8	3/8"	28	48	1	36,38
14100A-7/16	7/16"	28	48	1	36,38
14100A-1/2	1/2"	28	48	1	36,38

NEW

Cr-Mo.9mm
Cr-Mo.8mm
Cr-Mo.6mm
Cr-Mo.5mm
Cr-Mo.3mm

profilo speciale

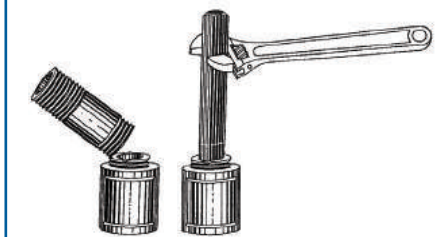

articolo	DESCRIZIONE	Euro
5538	SET 5 PEZZI, ESTRATTORI PER VITI E BULLONI SPEZZATI	12,90

- CARATTERISTICHE**
- in Cromo-Molibdeno, finitura fosfata
 - per la rimozione di viti, tubi, bulloni e prigionieri spezzati
 - misure:
 - metriche: 3 - 5 - 6 - 8 - 9 mm
 - pollici: 1/8" - 3/16" - 15/64" - 5/16" - 3/8"

ESAGONO 1/4" E

PRO+

articolo	DESCRIZIONE	Euro
BGS 5282	SET 5 PEZZI, ESTRATTORI PER VITI	14,03

CARATTERISTICHE

- acciaio al carbonio
- per tutti i tipi di viti a croce, TORX e con esagono incassato
- 5 formati diversi
- per utilizzo con trapano elettrico, max. 250 giri/min

CV

PRO+

articolo	DESCRIZIONE	Euro
BGS 5280	SET 13 PEZZI, ESTRATTORI PER VITI	25,50

CARATTERISTICHE

- in acciaio S2
- 6 estrattori con filetto sx
- 3x estrattori conici, 3-14 mm
- 3x estrattori cilindrici, 2-3,2-4,2 mm
- 6 inserti: PH 1, PH 2, PZ 1, PZ 2, Taglio 4, Taglio 5
- 1 portainseri con sgancio rapido

NEW

ESAGONO 1/4" E

PRO+

articolo	DESCRIZIONE	Euro
BGS 50410	SET 5 PEZZI, ESTRATTORI PER VITI	11,44

CARATTERISTICHE

- per tutti i tipi di viti a croce, TORX e esagonali
- adatto per utilizzo con trapano elettrico a velocità regolabile
- attacco esagonale 1/4"
- comprende 5 estrattori: 0-0-1-2-3
- - # 0 per 6 mm, velocità 700 - 800 giri al minuto
- - # 1 per 8 mm velocità 600-700 giri al minuto
- - # 2 per 10 mm, velocità 500 - 600 giri al minuto
- - # 3 per 12 mm, velocità 400-500 giri al minuto

NEW

TORX

PRO+

articolo	DESCRIZIONE	Euro
BGS 9170	SET 11 PEZZI, ESTRATTORI PER VITI TORX DANNEGGIATE, TX10-TX55	39,53

CARATTERISTICHE

- consente la rimozione di viti con impronta Torx danneggiata
- comprende:
 - inserti con attacco esagonale 1/4", lungh. 50 mm, per Torx: TX10 - TX15 - TX20 - TX25 - TX30 - TX40
 - inserti con attacco esagonale 10 mm (3/8"), lungh. 38 mm, per Torx: TX45 - TX50 - TX55
 - adattatore quadro femmina 1/2", per inserti con attacco esagonale 10 mm (3/8")

NEW



PRO+

BGS articolo	DESCRIZIONE	Euro
BGS 5284	SET 7 PEZZI, ESTRATTORI PER VITI TORX DANNEGGIATE, TX10-TX40, ATT. 1/4", 50 MM	23,97

CARATTERISTICHE

- consente la rimozione di viti con impronta Torx danneggiata
- comprende inserti con attacco esagonale 1/4", lungh. 50 mm, per Torx: TX10 - TX15 - TX20 - TX25 - TX27 - TX30 - TX40

NEW



PRO+

BGS articolo	DESCRIZIONE	Euro
BGS 5289	SET 7 PEZZI, ESTRATTORI PER VITI ESAGONALI DANNEGGIATE, 1,5-6 MM, ATT. 1/4", 50 MM	22,44

CARATTERISTICHE

- consente la rimozione di viti con impronta Esagonale danneggiata
- comprende inserti con attacco esagonale 1/4", lungh. 50 mm, per Esagono: 1,5 - 2 - 2,5 - 3 - 4 - 5 - 6 mm



BGS articolo	DESCRIZIONE	Euro
BGS 8549	SET 6 PEZZI, ESTRATTORI PER VITI	15,75

CARATTERISTICHE

- per estrarre viti danneggiate
- misure: 1 - 2 - 3 - 4 - 5 e 6
- attacco quadro



BGS articolo	DESCRIZIONE	Euro
BGS 1895	SET 5 PEZZI, ESTRATTORI VITI, DIMENSIONI 1-5	4,59

CARATTERISTICHE

- per la rimozione di viti spezzate
- per viti delle seguenti misure:
 - 3 - 6 mm (1/8" - 1/4")
 - 6 - 8 mm (1/4" - 5/16")
 - 8 - 11 mm (5/16" - 7/16")
 - 11 - 14 mm (7/16" - 9/16")
 - 14 - 19 mm (9/16" - 3/4")
- in acciaio al carbonio
- In custodia in plastica



BGS articolo	DESCRIZIONE	Euro
BGS 1896	SET 6 PEZZI, ESTRATTORI VITI, DIMENSIONI 1-6	6,89

CARATTERISTICHE

- per la rimozione di viti spezzate
- per viti delle seguenti misure:
 - 3 - 6 mm (1/8" - 1/4")
 - 6 - 8 mm (1/4" - 5/16")
 - 8 - 11 mm (5/16" - 7/16")
 - 11 - 14 mm (7/16" - 9/16")
 - 14 - 19 mm (9/16" - 3/4")
 - 19 - 25 mm (3/4" - 1")
- in acciaio al carbonio
- In custodia in plastica



BGS articolo	DESCRIZIONE	Euro
BGS 1897	SET ESTRATTORI VITI DA 8 PEZZI	27,30

CARATTERISTICHE

- per viti delle seguenti misure:
 - M3-6, M6-8, M8-11, M11-14, M14-18, M18-25, M25-35, M35-50

HSS



PRO+

BGS articolo	DESCRIZIONE	Euro
BGS 8462	SET 25 PEZZI, ESTRATTORI HSS PER VITI	76,37

CARATTERISTICHE

- per l'estrazione di viti e perni
- aiuta a ridurre i tempi ed i costi di lavorazione
- contenuto:
 - 5 punte HSS: 3,2 - 4,8 - 6,4 - 8,0 - 8,7 mm
 - 10 boccole guida per punte
 - 5 cacciapine
 - 5 adattatori
- in acciaio HSS



Koken articolo	DESCRIZIONE	Euro
RS3129/6-L32	Set 6 pezzi	69,60
RICAMBI		
3129-32	2, 3, 4, 6, 8, 10	



Koken articolo	DESCRIZIONE	Euro
RS4129/5-L37	Set 5 pezzi	72,41
RICAMBI		
4129-37	8, 10, 12, 14, 16	

3/8



BOLT TWISTER®

BUSSOLA ESTRATTORE PER VITI SPEZZATE ATTACCO 3/8" TIPO LUNGO



Koken articolo	D mm	L mm		Euro
3129-60-2	2	60	1	12,98
3129-60-3	3	60	1	12,98
3129-60-4	4	60	1	12,98
3129-60-6	6	60	1	12,98
3129-60-8	8	60	1	12,98
3129-60-10	10	60	1	12,98

1/2"



BOLT TWISTER®

BUSSOLA ESTRATTORE PER VITI SPEZZATE - ATTACCO 1/2" TIPO LUNGO

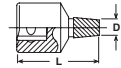

Koken articolo	D mm	L mm		Euro
4129-75-8	8	75	1	16,09
4129-75-10	10	75	1	16,09
4129-75-12	12	75	1	16,09
4129-75-14	14	75	1	16,09
4129-75-16	16	75	1	20,65

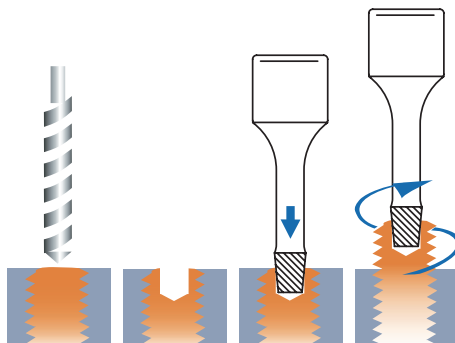



Koken articolo	DESCRIZIONE	Euro
RS3129/6-L60	Set 6 pezzi	75,13
RICAMBI		
3129-60	2, 3, 4, 6, 8, 10	



Koken articolo	DESCRIZIONE	Euro
RS4129/5-L75	Set 5 pezzi	82,12
RICAMBI		
4129-75	8, 10, 12, 14, 16	

3/8



BOLT TWISTER®

BUSSOLA ESTRATTORE PER VITI SPEZZATE ATTACCO 3/8"

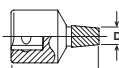

Koken articolo	D mm	L mm		Euro
3129-32-2	2	32	1	12,07
3129-32-3	3	32	1	12,07
3129-32-4	4	32	1	12,07
3129-32-6	6	32	1	12,07
3129-32-8	8	32	1	12,07
3129-32-10	10	32	1	12,07

1/2"



BOLT TWISTER®

BUSSOLA ESTRATTORE PER VITI SPEZZATE ATTACCO 1/2"



Koken articolo	D mm	L mm		Euro
4129-37-8	8	37	1	14,58
4129-37-10	10	37	1	14,58
4129-37-12	12	37	1	14,58
4129-37-14	14	37	1	14,58
4129-37-16	16	37	1	16,75





3/8"

PRO+



BGS articolo	DESCRIZIONE	Euro
BGS 5281	SET 6 PEZZI ESTRATTORI A SPIRALE, 2-10 MM, ATTACCO 3/8"	49,73

CARATTERISTICHE

- 2-3-4-6-8-10 mm
- per l'allentamento di viti e dadi danneggiati
- idonee per avvitatori
- l'innovativo profilo a spirale penetra nella testa di una vite o di un dado danneggiati, consentendo così di svitarli in sicurezza

RICAMBI

BGS articolo	DESCRIZIONE	Euro
BGS 5281-2	ESTRATTORE, 2 MM	6,38
BGS 5281-3	ESTRATTORE, 3 MM	6,38
BGS 5281-4	ESTRATTORE, 4 MM	6,63
BGS 5281-6	ESTRATTORE, 6 MM	6,63
BGS 5281-8	ESTRATTORE, 8 MM	6,89
BGS 5281-10	ESTRATTORE, 10 MM	7,14

ESAGONO
13 mm

PRO+

BGS articolo	DESCRIZIONE	Euro
BGS 8547	SET 10 PEZZI, ESTRATTORI PER VITI	32,64

CARATTERISTICHE

- per l'estrazione di viti con testa danneggiata
- per viti esagonali, Torx e Taglio
- attacco esagonale da 13 mm
- estrattore con attacco esagonale delle seguenti misure: 3 - 4 - 5,5 - 6 - 7 - 8 - 9 - 10 e 11 mm
- anche per viti con misure in pollici:
1/8" - 5/32" - 3/16" - 7/32" - 1/4" - 9/32" - 5/16"
11/32" - 3/8" e 13/32"

NOTE



BUSSOLA ESTRATTORE PER DADI BULLONI E BORCHIE ATTACCO 1/4"

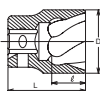

Koken articolo	Ø mm	D mm	ℓ mm	L mm		Euro
2127-4	4	7	4	23	1	26,54
2127-4.5	4.5	7.4	4	23	1	26,54
2127-5	5	8	5	23	1	26,54
2127-5.5	5.5	8.8	5	23	1	26,54
2127-6	6	9.5	6	23	1	26,54
2127-7	7	10.9	6	23	1	26,54
2127-8	8	11.5	8	23	1	26,90
2127-9	9	13	8	23	1	26,90
2127-9.5	9.5	13.8	10	23	1	26,90
2127-10	10	14.8	10	23	1	26,90



BUSSOLA ESTRATTORE PER dadi bulloni e borchie ATTACCO 3/8" - TIPO LUNGO

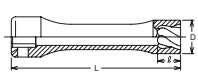

Koken articolo	Ø mm	D mm	ℓ mm	L mm		Euro
3128-8	8	11.5	6	80	1	44,03
3128-9	9	13.0	6	80	1	44,03
3128-10	10	14.8	8	80	1	44,03
3128-11	11	16.0	8	80	1	44,03
3128-12	12	17.0	10	80	1	44,03
3128-13	13	18.5	10	80	1	46,48
3128-14	14	19.7	12	80	1	46,48



ESTRATTORI A BUSSELLA DOPPI PER BULLONI DI SICUREZZA

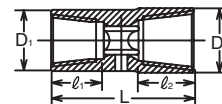

Koken articolo	Ø mm	D ₁ mm	D ₂ mm	L mm		Euro	
14124-21x24.5	21	24.5	28	29.5	65	1	33,88
14124-26x27.5	26	27.5	31.5	35	65	1	46,20



BUSSOLA ESTRATTORE PER DADI BULLONI E BORCHIE ATTACCO 3/8"

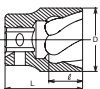

Koken articolo	Ø mm	D mm	ℓ mm	L mm		Euro
3127-8	8	11.5	8	32	1	31,85
3127-9	9	13.0	8	32	1	31,85
3127-9.5	9.5	13.8	8	32	1	31,85
3127-10	10	14.8	10	32	1	31,85
3127-11	11	16.0	10	32	1	31,85
3127-12	12	17.0	12	32	1	31,85
3127-13	13	18.5	12	32	1	31,85
3127-14	14	19.7	14	32	1	31,85
3127-15	15	20.7	14	32	1	31,85
3127-16	16	22.2	14	32	1	34,84
3127-17	17	23.5	16	35	1	34,84
3127-19	19	26.0	16	35	1	34,84



BUSSOLA ESTRATTORE PER DADI BULLONI E BORCHIE ATTACCO 1/2" - TIPO LUNGO

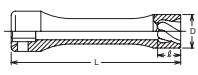

Koken articolo	Ø mm	D mm	ℓ mm	L mm		Euro
4128-17	17	23.5	16	120	1	67,35
4128-19	19	26.0	16	120	1	67,35
4128-21	21	28.0	17	120	1	67,35
4128-22	22	29.5	17	120	1	67,35



Koken articolo	DESCRIZIONE	Euro
14124/3	Set 3 pezzi	97,60
RICAMBI		
	14124 21x24.5, 26x27.5	
ACCESSORI 14760-75B 		



BUSSOLA ESTRATTORE PER DADI BULLONI E BORCHIE ATTACCO 1/2"

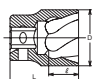

Koken articolo	Ø mm	D mm	ℓ mm	L mm		Euro
4127-14	14	19.7	14	42	1	39,74
4127-17	17	23.5	16	42	1	39,74
4127-19	19	26.0	16	42	1	39,74
4127-21	21	28.0	17	42	1	39,74
4127-22	22	29.5	17	42	1	39,74
4127-24	24	32.0	18	42	1	39,74
4127-25.4	25.4	33.5	18	42	1	39,74



BOLT TWISTER®

Soluzione semplice e efficace per la rimozione di bulloni con la testa rotta. Praticare un foro nel centro del filetto e svitare. I bordi taglienti a spirale lo rimuoveranno facilmente.



BUSSOLE PER BULLONI DI SICUREZZA

9 BUSSOLE PER BULLONI DI SICUREZZA

BUSSOLE PER BULLONI DI SICUREZZA

1/2"



**ESTRATTORI A
BUSSOLA PER
BULLONI DI
SICUREZZA**

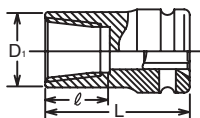

Kokon articolo	Ø	D mm	l mm	L mm	📦	Euro
14124-17	17	20.5	15	50	1	28,63
14124-18	18	21	15	50	1	28,63
14124-18.5	18.5	23	15	50	1	28,63
14124-19	19	25	20.5	50	1	31,96
14124-21	21	28	20.5	50	1	33,85
14124-24.5	24.5	29.5	23	50	1	33,85
14124-26	26	31.5	23	50	1	34,71
14124-27.5	27.5	35	23	50	1	35,42



Kokon articolo	DESCRIZIONE	Euro
RS14124/7	Set 7 pezzi	218,27
RICAMBI		
14124	Ø18, Ø18.5, Ø19, Ø21, Ø24.5, Ø26, Ø27.5	



1/2"

PRO+

BGS articolo	DESCRIZIONE	Euro
BGS 8656	SET 10 PEZZI, ESTRATTORI, ATT. 1/2"	136,25

CARATTERISTICHE

- estrattori conici lunghezza 60 mm
- estrattori conici
- estrattori conici con Ø (max-min):
Ø 18.3x16.4 - Ø 19.5x17.6 - Ø 20.4x18.5 - Ø 21.6x19.7
- Ø 22.5x20.6 - Ø 23.6x21.7 - Ø 24.5x22.6 - Ø 25.5x23.6 mm
- con 2 leve di manovra per rimozione bulloni dalla bussola
- realizzati in materiale S45C e SCM440

RICAMBI

BGS articolo	DESCRIZIONE	Euro
BGS 8656-3	NEW ESTRATT. Ø 18,3 MM	12,75
BGS 8656-4	NEW ESTRATT. Ø 19,5 MM	12,75
BGS 8656-5	NEW ESTRATT. Ø 20,4 MM	12,75
BGS 8656-6	NEW ESTRATT. Ø 21,6 MM	12,75
BGS 8656-7	NEW ESTRATT. Ø 22,5 MM	14,03
BGS 8656-8	NEW ESTRATT. Ø 23,6 MM	15,81
BGS 8656-9	NEW ESTRATT. Ø 24,5 MM	14,03
BGS 8656-10	NEW ESTRATT. Ø 25,5 MM	15,81

1/2"

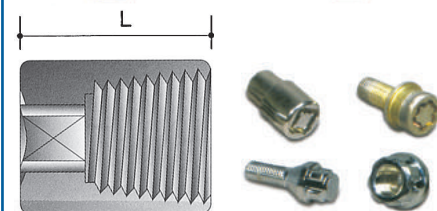

**CASSETTA 7 BUSSOLE SPECIALI PER
SVITARE BULLONI DI SICUREZZA NEI
CERCHI IN LEGA**
17-18,5-20-21,5-23-24,5-26 MM

attacco: 1/2"
impronta: FILETTO CONICO SINISTRO

FEEMEC articolo	Ø mm	L mm	📦	Euro
523017	17	38	1	15,75
523185	18,5	38	1	15,75
523200	20	38	1	15,75
523215	21,5	38	1	15,75
523230	23	38	1	15,75
523245	24,5	38	1	15,75
523260	26	38	1	15,75
523071	CASSETTA 7 PEZZI		1	102,90



1/2"

PRO+

CROMO

BGS articolo	DESCRIZIONE	Euro
BGS 5260	SET 4 PEZZI ESTRATTORI ATTACCO 1/2", 4 PEZZI	38,25

CARATTERISTICHE

- ideali per l'allentamento di viti e dadi fortemente danneggiati
- particolarmente indicate per dadi ruota, dadi di bloccaggio, ecc.
- misure 17-18,5-21,5-26 mm
- in custodia metallica





1/2"

PRO+

CROMO

ESTRATTORI, ATTACCO 1/2"

BGS articolo	DESCRIZIONE	Euro
BGS 5269-8	8 MM	9,69
BGS 5266-10	10 MM	10,71
BGS 5266-11	11 MM	10,71
BGS 5266-12	12 MM	10,97
BGS 5266-13	13 MM	10,97
BGS 5266-14	14 MM	11,22
BGS 5266-15	15 MM	11,99
BGS 5266-16	16 MM	12,24
BGS 5266-17	17 MM	12,50
BGS 5266-19	19 MM	13,26
BGS 5269-21	21 MM	11,22
BGS 5268-22	22 MM	14,28
BGS 5268-24	24 MM	14,79
BGS 5268-27	27 MM	15,05
BGS 5268-32	32 MM	22,25

CARATTERISTICHE

- finitura nera
- per l'allentamento di viti e dadi danneggiati
- idonee per uso con avvitatori
- l'innovativo profilo a spirale penetra nella testa di una vite o di un dado danneggiati, consentendo così di svitarli in sicurezza



3/8"

PRO+

CROMO

BGS articolo	DESCRIZIONE	Euro
BGS 5265	SET 10 PEZZI ESTRATTORI, 10-19 MM, 3/8"	91,25

CARATTERISTICHE

- finitura nera
- per svitare viti, dadi, perni, prigionieri, ecc. danneggiati o arrugginiti
- anche per uso con avvitatori ad impulsi
- l'innovativo profilo a spirale penetra nella testa di una vite o di un dado danneggiati, consentendo così di svitarli in sicurezza
- misure: 10-11-12-13-14-15-16-17-19 mm
- misure singole disponibili articoli BGS 5270-5279

RICAMBI

BGS articolo	DESCRIZIONE	Euro
BGS 5270	ESTRATTORE, 10 MM	12,50
BGS 5271	ESTRATTORE, 11 MM	12,50
BGS 5272	ESTRATTORE, 12 MM	12,50
BGS 5273	ESTRATTORE, 13 MM	12,50
BGS 5274	ESTRATTORE, 14 MM	13,52
BGS 5275	ESTRATTORE, 15 MM	13,52
BGS 5276	ESTRATTORE, 16 MM	13,52
BGS 5277	ESTRATTORE, 17 MM	13,52
BGS 5278	ESTRATTORE, 18 MM	13,52
BGS 5279	ESTRATTORE, 19 MM	13,52



1/2"

PRO+

CROMO

BGS articolo	DESCRIZIONE	Euro
BGS 5266	SET 10 PEZZI ESTRATTORI, 10-19 MM, 1/2"	99,88

CARATTERISTICHE

- finitura nera
- per l'allentamento di viti e dadi danneggiati
- idoneo per chiavi a impatto
- l'innovativo profilo a spirale penetra nella testa di una vite o di un dado danneggiati, consentendo così di svitarli in sicurezza
- misure: 10-11-12-13-14-15-16-17-19 mm

RICAMBI

BGS articolo	DESCRIZIONE	Euro
BGS 5266-10	ESTRATTORE, 10 MM	10,71
BGS 5266-11	ESTRATTORE, 11 MM	10,71
BGS 5266-12	ESTRATTORE, 12 MM	10,97
BGS 5266-13	ESTRATTORE, 13 MM	10,97
BGS 5266-14	ESTRATTORE, 14 MM	11,22
BGS 5266-15	ESTRATTORE, 15 MM	11,99
BGS 5266-16	ESTRATTORE, 16 MM	12,24
BGS 5266-17	ESTRATTORE, 17 MM	12,50
BGS 5266-19	ESTRATTORE, 19 MM	13,26



1/2"

PRO+

CROMO

BGS articolo	DESCRIZIONE	Euro
BGS 5269	SET 16 PEZZI, ESTRATTORI 8-27 MM, 1/2"	149,88

CARATTERISTICHE

- finitura nera
- per l'allentamento di viti e dadi danneggiati
- idonee per uso con avvitatori
- l'innovativo profilo a spirale penetra nella testa di una vite o di un dado danneggiati, consentendo così di svitarli in sicurezza
- misure: 8-10-11-12-13-14-15-16-17-19-21-22-24-27 mm



1/2" 3/4" PRO+ CROMO

BGS articolo	DESCRIZIONE	Euro
BGS 5268	SET 6 PEZZI, ESTRATTORI 22-41 MM, 1/2" + 3/4"	128,75

- CARATTERISTICHE**
- finitura nera
 - per l'allentamento di viti e dadi danneggiati
 - idonee per avvitatori
 - l'innovativo profilo a spirale penetra nella testa di una vite o di un dado danneggiati, consentendo così di svitarli in sicurezza
 - misure:
 - attacco 1/2": 22-24-27-32 mm
 - attacco 3/4": 36-41 mm
 - disponibili tutti i ricambi

RICAMBI

BGS articolo	DESCRIZIONE	Euro
BGS 5268-22	ESTR. ATT. 1/2", 22 MM	14,28
BGS 5268-24	ESTR. ATT. 1/2", 24 MM	14,79
BGS 5268-27	ESTR. ATT. 1/2", 27 MM	15,05
BGS 5268-32	ESTR. ATT. 1/2", 32 MM	22,25
BGS 5268-36	ESTR. ATT. 3/4", 36 MM	29,84
BGS 5268-41	ESTR. ATT. 3/4", 41 MM	37,74



1/2" PRO+ CROMO

BGS articolo	DESCRIZIONE	Euro
BGS 5262	SET 5 PEZZI, ESTRATTORI ATTACCO 1/2", LUNGHEZZA 150 MM	123,68

- CARATTERISTICHE**
- finitura nera
 - per l'allentamento di viti e dadi danneggiati
 - idonee per avvitatori
 - l'innovativo profilo a spirale penetra nella testa di una vite o di un dado danneggiati, consentendo così di svitarli in sicurezza
 - misure: 17 - 19 - 21 - 22 mm, con cacciaspine



1/2" PRO+ CROMO

BGS articolo	DESCRIZIONE	Euro
BGS 5264	SET 3 PEZZI, ESTRATTORI TIPO LUNGO, 17-19-21 MM + CACCIASPINE	93,59

- CARATTERISTICHE**
- finitura nera
 - per l'allentamento di viti e dadi danneggiati
 - idonee per avvitatori
 - l'innovativo profilo a spirale penetra nella testa di una vite o di un dado danneggiati, consentendo così di svitarli in sicurezza
 - lunghezza: 150 mm
 - BGS 5264** composto da:
 - estrattori: **17 - 19 - 21**
 - cacciaspine

RICAMBI

BGS articolo	DESCRIZIONE	Euro
BGS 5264-17	ESTRATTORE 17 MM	34,94
BGS 5264-19	ESTRATTORE 19 MM	34,17
BGS 5264-21	ESTRATTORE 21 MM	34,43
BGS 5264-22	ESTRATTORE 22 MM	37,38
BGS 5264-TB	CACCIASPINE	4,34



3/8" PRO+ CROMO

BGS articolo	DESCRIZIONE	Euro
BGS 20210	SET 10 PEZZI, ESTRATTORI 9-19 MM, ATTACCO 3/8"	42,90

- CARATTERISTICHE**
- per l'allentamento di viti e dadi danneggiati
 - l'innovativo profilo a spirale penetra nella testa di una vite o di un dado danneggiati, consentendo così di svitarli in sicurezza
 - misure: 9-10-11-12-13-14-15-16-17-19 mm
 - attacco quadro femmina 3/8" e esagonale esterno
 - in custodia di alluminio



1/2" PRO+ CROMO

BGS articolo	DESCRIZIONE	Euro
BGS 5261	SET 5 PEZZI ESTRATTORI A SPIRALE, 8-16 MM, ATTACCO 1/2"	52,53

- CARATTERISTICHE**
- 8-10-12-14-16 mm
 - finitura nera
 - per l'allentamento di viti e dadi danneggiati
 - idonee per avvitatori
 - l'innovativo profilo a spirale penetra nella testa di una vite o di un dado danneggiati, consentendo così di svitarli in sicurezza



3/8" PRO+ CROMO

BGS articolo	DESCRIZIONE	Euro
BGS 8383	SET 11 PEZZI, ESTRATTORI METRICI	72,68

- CARATTERISTICHE**
- bussole speciali per allentare le viti e dadi a testa esagonale rovinata
 - dimensioni: 8 - 9 - 10 - 11 - 12 - 13 - 14 - 15 - 16 - 17 - 19 mm
 - anche per serrare le viti
 - attacco quadro femmina: 3/8" (10 mm)
 - finitura cromata satinata
 - materiale: acciaio al cromo molibdeno



3/8"

PRO+

CRO
MO

BGS
articolo

DESCRIZIONE

Euro

BGS 8378

SET 17 PEZZI, ESTRATTORI PER VITI, DADI E PRIGIONIERI

127,37

CARATTERISTICHE

- per dadi, viti rovinati e prigionieri
- contenuto:
 - 5 estrattori sinistri per viti danneggiate
 - 4 estrattori per prigionieri 6 - 8 - 10 - 12 MM
 - 8 bussole speciali "Zig Zag" per dadi esagonali rovinati 9-10-11-12-13-14-16-19 mm
- attacco 3/8"
- tutti i componenti realizzati in acciaio al cromo molibdeno



PRO+

CRO
MO

BGS
articolo

DESCRIZIONE

Euro

BGS 5285

SET 3 PEZZI, CHIAVI A BUSSELLA SPECIALI PER VITI DI SICUREZZA CERCHI BMW

35,57

CARATTERISTICHE

- comprende: 17 T x 14,5 mm; 10 T x 16,0 mm; 21 T x 16,5 mm



1/2"



FEARTEC
articolo

DESCRIZIONE

Euro

8932

SET 21 PEZZI, INSERTI SPECIALI PER BULLONI DI SICUREZZA PER BMW

136,50

CARATTERISTICHE

- con inserti lunghezza 25 mm e attacco esagonale 17 mm
- comprende:
 - 20 inserti speciali con attacco esagonale 17 mm:
 - 13 punte con foro; 15 punte con foro; 16 punte con foro;
 - 16 punte; 14 punte; 15 punte
 - 17 punte con foro; 16 punte con foro; 19 punte con foro
 - 10 punte; 11 punte; 12 punte;
 - 20 punte con foro; 21 punte con foro; 22 punte con foro; 23 punte con foro
 - 13 punte; 7 punte; 9 punte; 8 punte
- bussola esagonale 17 mm rivestita, attacco 1/2"
- in cassetta

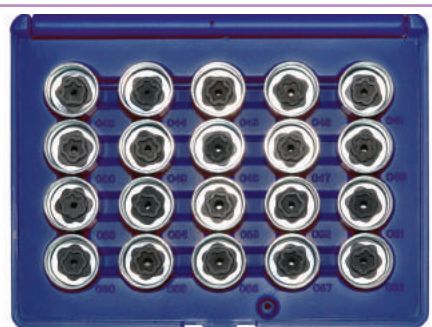

FEARTEC
articolo

DESCRIZIONE

Euro

BMW 20

SET 20 PEZZI, INSERTI SPECIALI PER BULLONI DI SICUREZZA PER BMW

199,50

CARATTERISTICHE

- comprende 20 inserti speciali con attacco esagonale 17 mm, lunghezza 37 mm



1/2"



FEARTEC
articolo

DESCRIZIONE

Euro

8933

SET 23 PEZZI, INSERTI SPECIALI PER BULLONI DI SICUREZZA PER VAG

152,25

CARATTERISTICHE

- con inserti lunghezza 25 mm e attacco esagonale 17 mm
- comprende:
 - 22 inserti speciali con attacco esagonale 17 mm:
 - 6 punte con foro; 7 punte con foro; 8 punte con foro; 9 punte con foro; 10 punte con foro; 11 punte con foro; 12 punte con foro; 13 punte con foro; 14 punte con foro; 15 punte con foro; 16 punte con foro; 17 punte con foro;
 - 10 punte; 11 punte; 13 punte; 14 punte; 15 punte; 16 punte; 17 punte; 19 punte; 20 punte; 21 punte
- bussola esagonale 17 mm rivestita, attacco 1/2"
- in cassetta

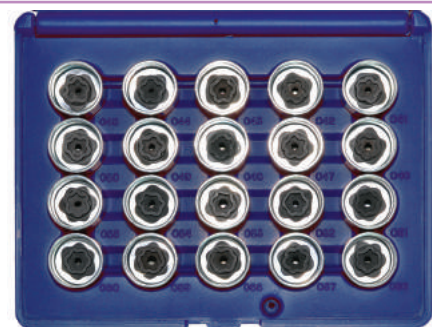

FEARTEC
articolo

DESCRIZIONE

Euro

VW 20

SET 20 PEZZI, INSERTI SPECIALI PER BULLONI DI SICUREZZA PER VW

199,50

CARATTERISTICHE

- comprende 20 inserti speciali con attacco esagonale 17 mm, lunghezza 37 mm

BUSSOLE PER BULLONI DI SICUREZZA

NEW



BGS   **PRO+**

BGS articolo	DESCRIZIONE	Euro
BGS 9099	SET 20 PEZZI, INSERTI SPECIALI PER BULLONI DI SICUREZZA PER PORSCHE & VW TOUAREG	193,75

- CARATTERISTICHE**
- comprende 20 inserti speciali con attacco esagonale 19 mm
 - nr.50x14-lati. - nr.51x15-lati. - nr.52x16-lati. - nr.53x17-lati. - nr.53x18-lati. - nr.55x19-lati. - nr.56x20-lati. - nr.57x21-lati. - nr.58x22-lati. - nr.59x23-lati. - nr.60x14-lati. - nr.61x15-lati. - nr.62x16-lati. - nr.63x17-lati. - nr.64x18-lati. - nr.65x19-lati. - nr.66x20-lati. - nr.67x21-lati. - nr.68x22-lati. - nr.69x23-lati.

NEW



BGS  **PRO+**

BGS articolo	DESCRIZIONE	Euro
BGS 9553	SET 10 PEZZI, INSERTI SPECIALI PER BULLONI DI SICUREZZA, PER LAND ROVER	163,75

CARATTERISTICHE

- comprende 10 inserti speciali con attacco esagonale 17 mm, lunghezza 37 mm
- in modulo per carrello

NEW



BGS  **CV** **PRO+**

BGS articolo	DESCRIZIONE	Euro
BGS 9499	SET 20 PEZZI, INSERTI SPECIALI PER BULLONI DI SICUREZZA PER AUDI	323,75

CARATTERISTICHE

- comprende 20 inserti speciali con attacco esagonale 17 mm
- per uso come OEM T40073

NEW



BGS   **PRO+**

BGS articolo	DESCRIZIONE	Euro
BGS 9338	SET 12 PEZZI, INSERTI SPECIALI PER BULLONI DI SICUREZZA, PER MERCEDES-BENZ	198,75

CARATTERISTICHE

- per uso sui seguenti veicoli Mercedes-Benz: A-Class, B-Class, C-Class, GLK-Class, CLC-Class, CLS-Class, CLK-Class, E-Class, SL-Class, SLK-Class, M-Class, R-Class
- in Cromo-Molibdeno
- comprende:
 - 10 inserti speciali per bulloni di sicurezza
 - 1 bussola esagonale porta-inserti
 - 1 cacciaspine
- in modulo per carrello da 1/6 di cassetto

NEW



BGS  **PRO+**

BGS articolo	DESCRIZIONE	Euro
BGS 9469	SET 35 PEZZI, INSERTI SPECIALI PER BULLONI DI SICUREZZA, PER MERCEDES	371,25

CARATTERISTICHE

- comprende:
 - 32 inserti speciali con attacco esagonale
 - bussola portainseriti speciali
 - caccia-spine
 - gancio per rimozione copri-dadi

NEW



BGS  **PRO+**

BGS articolo	DESCRIZIONE	Euro
BGS 9556	SET 20 PEZZI, INSERTI SPECIALI PER BULLONI DI SICUREZZA, PER OPEL/VAUXHALL (VERSIONE A)	337,38

CARATTERISTICHE

- comprende 20 inserti speciali con attacco esagonale 17 mm

NEW

1/6 OPEL PRO+

BGS articolo	DESCRIZIONE	Euro
BGS 9557	SET 20 PEZZI, INSERTI SPECIALI PER BULLONI DI SICUREZZA, PER OPEL/VAUXHALL (VERSIONE B)	337,38

CARATTERISTICHE

- comprende 20 inserti speciali con attacco esagonale 17 mm

NEW

1/6 OPEL PRO+

BGS articolo	DESCRIZIONE	Euro
BGS 9559	SET 7 PEZZI, INSERTI SPECIALI PER BULLONI DI SICUREZZA, PER OPEL/VAUXHALL (VERSIONE D)	142,00

CARATTERISTICHE

- comprende 7 inserti speciali con attacco esagonale 17 mm

NEW

VOLVO 1/6 PRO+ CV

BGS articolo	DESCRIZIONE	Euro
BGS 9653	SET 20 PEZZI, INSERTI SPECIALI PER BULLONI DI SICUREZZA, PER VOLVO	302,00

CARATTERISTICHE

- in modulo per carrello
- comprende 20 inserti speciali con attacco esagonale 19 mm, lunghezza 42,5 mm

NEW

1/6 OPEL PRO+

BGS articolo	DESCRIZIONE	Euro
BGS 9558	SET 20 PEZZI, INSERTI SPECIALI PER BULLONI DI SICUREZZA, PER OPEL/VAUXHALL (VERSIONE C)	337,38

CARATTERISTICHE

- comprende 20 inserti speciali con attacco esagonale 17 mm

NEW

VOLVO 1/6 PRO+ CV

BGS articolo	DESCRIZIONE	Euro
BGS 9652	SET 20 PEZZI, INSERTI SPECIALI PER BULLONI DI SICUREZZA, PER VOLVO	396,25

CARATTERISTICHE

- in modulo per carrello
- comprende 20 inserti speciali con attacco esagonale 19 mm, lunghezza 36 mm

NEW

Mercedes-Benz

BGS articolo	DESCRIZIONE	Euro
MB 30	SET 30 PEZZI, INSERTI SPECIALI PER BULLONI DI SICUREZZA PER MERCEDES-BENZ	370,00

CARATTERISTICHE

- comprende 30 inserti speciali con attacco esagonale 17 mm, lunghezza 43 mm



BUSSOLE PER BULLONI DI SICUREZZA

NEW

HYUNDAI KIA
1/2" PRO+

BGS articolo	DESCRIZIONE	Euro
BGS 9371	BUSSOLA CON RIVESTIMENTO IN PLASTICA, 21 MM, PER BULLONI HYUNDAI I30, TUCSON & KIA	20,15

CARATTERISTICHE

- bussola rivestita in plastica, particolarmente idonea in presenza di cerchi in alluminio
- adatta per uso con avvitatori

19.35 mm
16.10 mm

1/2" Mercedes-Benz

DESCRIZIONE	Euro
BUSSOLA PER NUOVI BULLONI RUOTE MERCEDES, LUNGHEZZA 78 MM	11,55

CARATTERISTICHE

- chiave per allentare o avvitare dadi o viti ruote con profilo Socket MS 17. Montate su Mercedes
- diametro: 26 mm
- lunghezza: 78 mm

NEW

3/4" PRO+

BGS articolo	DESCRIZIONE	Euro
BGS 9769	BUSSOLA SPECIALE PER MONODADO DI SERRAGGIO CENTRALE, SU PORSCHE 911 (991)	158,75

CARATTERISTICHE

- per i modelli Porsche 911 (991) con monodado centrale (OEM 99136108190): GT3 / GT3 RS / Turbo / Turbo S (a partire dal 2010) Carrera GTS (a partire dal 2011)
- attacco quadro femmina: 3/4" (20 mm)
- materiale: lega di alluminio
- non adatto per uso con avvitatori a percussione**

NEW

23mm 5PT

LEXUS PRO+ CV

BGS articolo	DESCRIZIONE	Euro
BGS 9270	BUSSOLA SPECIALE 5 LATI, PER BULLONI DI SICUREZZA TOYOTA E LEXUS	26,78

CARATTERISTICHE

- dimensioni: 23 mm x 5 lati
- anche per uso con avvitatore

19.35 mm
16.10 mm

1/2" Mercedes-Benz

DESCRIZIONE	Euro
BUSSOLA CON RIVESTIMENTO IN PLASTICA PER NUOVI BULLONI RUOTE MERCEDES, LUNGHEZZA 78 MM	12,60

CARATTERISTICHE

- chiave per allentare o avvitare dadi o viti ruote con profilo Socket MS 17. Montate su Mercedes
- bussola rivestita in plastica, particolarmente idonea in presenza di cerchi in alluminio
- diametro: 27 mm
- lunghezza: 78 mm

NEW

VW OPEL RENAULT NISSAN Mercedes-Benz
3/4" PRO+ CROMO

BGS articolo	DESCRIZIONE	Euro
BGS 9617	CHIAVE DI SERRAGGIO PER GHIERE, PER MOZZI RUOTA, DENTI ESTERNI, PER MERCEDES-BENZ, NISSAN, OPEL, RENAULT, VW	85,43

CARATTERISTICHE

- per allentare il dado della scanalatura sui mozzi delle ruote posteriori
- per:
 - Volkswagen Crafter / LT
 - Opel / Vauxhall Movano
 - Renault Master
 - Nissan Interstar
 - Mercedes-Benz Sprinter (con doppia ruota)
 - assale posteriore Mercedes: 741,130, -131, -413, -414, -416, -420, -422, -453, -454, -455, -429
- per uso come OEM: VW T50017, Opel / Vauxhall CH50112, Mercedes-Benz 906589000700
- profilo guida: quadrato interno
- attacco quadro: 3/4" (20 mm)
- materiale: acciaio al cromo molibdeno
- lunghezza: 74 mm



NEW



PER BULLONI DI SICUREZZA CON ANELLO GIREVOLE BMW, MINI & VW



(1) AVVITARE SALDAMENTE L'ESTRATTORE REGOLABILE AL BULLONE



(2) UNIRE IL MATELLO A MASSA BATTENTE ED APPLICARE FORZA FINO ALLA ROTTURA DEL BULLONE



(3) IL BULLONE DI SICUREZZA SI SEPARA IN TRE PARTI



(4) COLLOCARE L'ESTRATTORE PER BULLONI PER SVITARE LA PARTE DI BULLONE ANCORA AVVITATA



(5) RIMUOVERE IL BULLONE DALL'ESTRATTORE CON L'AUTO DEL CACCIASPINE

FERMEC
articolo
PULLER

DESCRIZIONE

SET 4 PEZZI, ESTRATTORE PER BULLONI DI SICUREZZA BMW, MINI E VW

Euro

160,00

CARATTERISTICHE

- per uso con bulloni di sicurezza con anello girevole BMW, MINI e VW
- comprende:
 - martello a massa battente 1,5 kg
 - estrattore regolabile
 - estrattore per bulloni
 - cacciaspine
- in cassetta in plastica

RICAMBI

FERMEC
articolo
PULLER-1

DESCRIZIONE

ESTRATTORE CON GRIFFE

Euro

95,00

PULLER-2

PERNO CON IMPRONTA MULTIRICHE

30,00

BUSSOLE PER BULLONI DI SICUREZZA



CASSETTE METALLICHE PORTA-BUSSOLE

FEARMEC articolo	Dimensioni (lunghezza x larghezza x altezza) mm		Euro
CASS-2510	280 x 100 x 40 mm	1	26,25
CASS-3112	310 x 120 x 80 mm	1	39,90
CASS-3211	320 x 115 x 50 mm	1	42,00
CASS-6213	610 x 130 x 85 mm	1	55,00

NOTE

- a richiesta assortimento di bussole a macchina in cassetta metallica

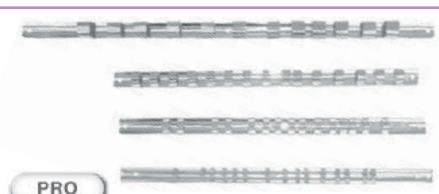

PRO

GUIDE PORTA BUSSOLE CON CLIP

BG articolo	Numero Clip	Euro
BG 2316 1/4"	7	2,93
BG 2317 3/8"	7	3,19
BG 2318 1/2"	7	3,32
BG 2120 1/4"	15	4,08
BG 2330 3/8"	15	4,59
BG 2540 1/2"	15	4,46
BG 3460 3/4"	12	8,93

CARATTERISTICHE

- cromato satinato



GUIDE PORTA BUSSOLE PER MOLLE IN ACCIAIO DA 1/4" - 3/8" - 1/2" - 3/4"

Koken articolo	L mm		Euro
R 158	158	1	2,52
R 251	251	1	2,56
R 300	300	1	2,62
R 400	400	1	2,71



MOLLE IN ACCIAIO PER GUIDE

Koken articolo	Euro
C 14 1/4"	0,34
C 38 3/8"	0,34
C 12 1/2"	0,34
C 34 3/4"	0,50

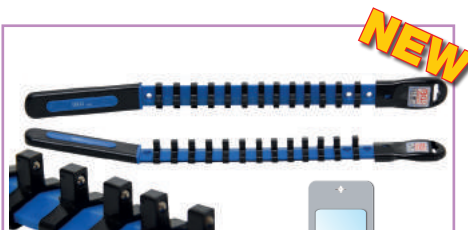

GUIDE PORTA BUSSOLE CON CLIP

BG articolo	Numero Clip	Euro
BG 9193 1/4"	13	3,83
BG 9194 3/8"	11	4,08
BG 9195 1/2"	9	4,34

CARATTERISTICHE

- clip con sfere di tenuta



GUIDE MAGNETICHE PORTA BUSSOLE CON CLIP

BG articolo	Numero Clip	L mm	Euro
BG 9342 1/4"	12	310	22,19
BG 9343 3/8"	12	310	22,44
BG 9344 1/2"	12	310	22,70

CARATTERISTICHE

- clip con sfera per bussole realizzate in plastica rinforzata
- magneti rivestiti in gomma protettiva



GUIDE MAGNETICHE PORTA BUSSOLE CON CLIP



Koken articolo	Nr. Clip	L mm		Euro
RSAL200-1/4x12 1/4"	12	200	1	37,68
RSAL200-3/8x8 3/8"	8	200	1	35,56
RSAL300-3/8x12 3/8"	12	300	1	42,90
RSAL300-1/2x10 1/2"	10	300	1	44,85



GUIDE PORTA BUSSOLE MAGNETICHE PER MOLLE IN PLASTICA



Koken articolo	L mm		Euro
RSAL-200	200	1	31,54
RSAL-300	300	1	36,63



ESAGONO

CHIAVI A BUSSOLA A
MANO BOCCA ESAGONALE

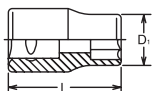

Koken articolo	mm	D ₁ mm	L mm		Euro
2400M-3	3	5.5	22	1	3,55
2400M-3.5	3.5	6.1	22	1	3,55
2400M-4	4	6.7	22	1	3,55
2400M-4.5	4.5	7.3	22	1	3,55
2400M-5	5	8	22	1	3,55
2400M-5.5	5.5	8.5	22	1	3,55
2400M-6	6	9.2	22	1	3,55
2400M-7	7	10.3	22	1	3,55
2400M-8	8	11.2	22	1	3,55
2400M-9	9	13	22	1	3,55
2400M-10	10	14.3	22	1	3,55
2400M-11	11	15.5	22	1	3,77
2400M-12	12	16.8	22	1	3,77
2400M-13	13	18	22	1	3,96
2400M-14	14	19.3	24	1	4,48

POLLICI



ESAGONO

CHIAVI A BUSSOLA A
MANO BOCCA ESAGONALE

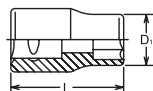

Koken articolo	pollici	D ₁ mm	L mm		Euro
2400A-1/8	1/8"	5.2	22	1	3,85
2400A-5/32	5/32"	6.7	22	1	3,85
2400A-3/16	3/16"	7.7	22	1	3,85
2400A-7/32	7/32"	8.8	22	1	3,85
2400A-1/4	1/4"	9.6	22	1	3,85
2400A-9/32	9/32"	10.2	22	1	3,85
2400A-5/16	5/16"	11.3	22	1	3,85
2400A-11/32	11/32"	13	22	1	3,85
2400A-3/8	3/8"	14.3	22	1	3,85
2400A-7/16	7/16"	16	22	1	4,02
2400A-1/2	1/2"	18	22	1	4,24
2400A-9/16	9/16"	19.3	24	1	4,87

POLLICI



POLIGONALE

CHIAVI A BUSSOLA A
MANO BOCCA POLIGONALE

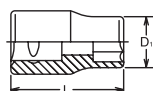

Koken articolo	pollici	D ₁ mm	L mm		Euro
2405A-1/8	1/8"	5.2	22	1	3,85
2405A-5/32	5/32"	6.7	22	1	3,85
2405A-3/16	3/16"	7.7	22	1	3,85
2405A-7/32	7/32"	8.8	22	1	3,85
2405A-1/4	1/4"	9.6	22	1	3,85
2405A-9/32	9/32"	10.2	22	1	3,85
2405A-5/16	5/16"	11.3	22	1	3,85
2405A-11/32	11/32"	13	22	1	3,85
2405A-3/8	3/8"	14.3	22	1	3,85
2405A-7/16	7/16"	16	22	1	4,02
2405A-1/2	1/2"	18	22	1	4,24
2405A-9/16	9/16"	19.3	24	1	4,87

SURFACE
DRIVE

CHIAVI A BUSSOLA A
MANO BOCCA SURFACE
DRIVE

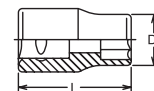

Koken articolo	mm	D ₁ mm	L mm		Euro
2410M-4	4	6.7	22	1	3,77
2410M-4.5	4.5	7.3	22	1	3,77
2410M-5	5	8	22	1	3,77
2410M-5.5	5.5	8.5	22	1	3,77
2410M-6	6	9.2	22	1	3,77
2410M-7	7	10.3	22	1	3,77
2410M-8	8	11.2	22	1	3,77
2410M-9	9	13	22	1	3,77
2410M-10	10	14.3	22	1	3,77
2410M-11	11	15.5	22	1	3,93
2410M-12	12	16.8	22	1	3,93
2410M-13	13	18	22	1	4,13
2410M-14	14	19.3	24	1	4,76



POLIGONALE

CHIAVI A BUSSOLA A
MANO BOCCA POLIGONALE

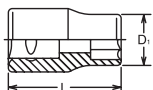

Koken articolo	mm	D ₁ mm	L mm		Euro
2405M-3	3	5.5	22	1	3,55
2405M-3.5	3.5	6.1	22	1	3,55
2405M-4	4	6.7	22	1	3,55
2405M-4.5	4.5	7.3	22	1	3,55
2405M-5	5	8	22	1	3,55
2405M-5.5	5.5	8.5	22	1	3,55
2405M-6	6	9.2	22	1	3,55
2405M-7	7	10.3	22	1	3,55
2405M-8	8	11.2	22	1	3,55
2405M-9	9	13	22	1	3,55
2405M-10	10	14.3	22	1	3,55
2405M-11	11	15.5	22	1	3,77
2405M-12	12	16.8	22	1	3,77
2405M-13	13	18	22	1	3,96
2405M-14	14	19.3	24	1	4,48



ESAGONO



CHIAVI A BUSSOLA
BOCCA ESAGONALE
EXTRA CORTE

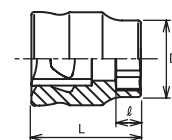

Koken articolo	mm	D ₁ mm	L mm		Euro
2400MZ-4	4	6.4	14	1	5,97
2400MZ-4.5	4.5	7	14	1	5,97
2400MZ-5	5	7.6	14	1	5,97
2400MZ-5.5	5.5	8.2	14	1	5,97
2400MZ-6	6	8.8	14	1	5,97
2400MZ-7	7	9.9	14	1	5,97
2400MZ-8	8	11.1	15	1	6,19
2400MZ-10	10	13.5	15	1	6,19
2400MZ-11	11	14.7	15	1	6,19
2400MZ-12	12	15.9	15	1	6,19
2400MZ-13	13	17.1	15	1	6,74
2400MZ-14	14	18.3	15	1	6,74





**OTTAGONALE
OTTO ANGOLI**

CHIAVI A BUSSOLA
A MANO BOCCA
OTTAGONALE

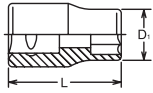

Koken articolo		D ₁ mm	L mm		Euro
NEW 2415M-5.5	5.5	10.3	22	1	5,75
2415M-6	6	11	22	1	5,72
NEW 2415M-7	7	12.5	22	1	5,91
2415M-8	8	14.3	22	1	5,72
2415M-10	10	17.4	22	1	5,72
POLLICI					
2415A-1/4	1/4"	11	22	1	4,87
2415A-5/16	5/16"	14.3	22	1	4,87
2415A-3/8	3/8"	17.4	22	1	5,61



**NUT GRIP®
BLOCCADADI**

CHIAVI A BUSSOLA A
MANO BOCCA NUT GRIP®

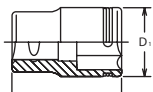

Koken articolo		D ₁ mm	L mm		Euro
2450MS-7	7	11.3	18	1	9,16
2450MS-8	8	12.3	18	1	9,16
2450MS-10	10	14.3	19	1	9,16
2450MS-12	12	17.4	20	1	9,16
2450MS-13	13	18	20	1	9,35
2450MS-14	14	19.9	22	1	9,35



TORX®

CHIAVI A BUSSOLA A
MANO BOCCA TORX®

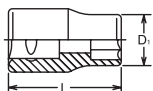

Koken articolo		D ₁ mm	L mm		Euro
2425-E 4	E 4	11.2	22	1	4,46
2425-E 5	E 5	11.2	22	1	4,46
2425-E 6	E 6	11.2	22	1	4,46
2425-E 7	E 7	11.2	22	1	4,46
2425-E 8	E 8	11.2	22	1	4,46
2425-E 10	E10	12	22	1	4,46
NEW 2425-E 11	E11	12.9	22	1	8,14
NEW 2425-E 12	E12	14.3	23	1	8,47



SERIE 11 PZ. CHIAVI A BUSSOLA
MISURE: 4, 5, 6, 7, 8, 9, 10, 11, 12, 13, 14 MM
DISPONIBILI CON BOCCA:
ESAGONALE/POLIGONALE/SURFACE DRIVE

Koken articolo		L mm		Euro
RS2400M/11		22	1	39,41
RS2405M/11		22	1	39,41
RS2410M/11		22	1	40,51

POLLICI



SERIE 9 PZ. CHIAVI A BUSSOLA
MISURE: 3/16", 7/32", 1/4", 9/32", 5/16",
11/32", 3/8", 7/16", 1/2"
DISPONIBILI CON BOCCA:
ESAGONALE/POLIGONALE

Koken articolo		L mm		Euro
RS2400A/9		22	1	33,91
RS2405A/9		22	1	33,91



TORX®

SERIE 6 PZ. CHIAVI A BUSSOLA
MISURE: E4, E5, E6, E7, E8, E10
BOCCA TORX

Koken articolo		L mm		Euro
RS2425/6		22	1	26,02

TORX®	S mm	S mm	
E 4	3.70	E 16	14.60
E 5	4.60	E 18	16.50
E 6	5.60	E 20	18.30
E 7	6.10	E 22	20.10
E 8	7.40	E 24	22.00
E 10	9.30	E 26	23.70
E 11	9.90	E 28	25.50
E 12	11.00	E 30	27.30
E 14	12.80	E 32	29.00



ESAGONO

CHIAVI A BUSSOLA A
MANO BOCCA ESAGONALE

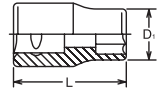

Koken articolo		D ₁ mm	L mm		Euro
2300M-3	3	5.4	50	1	7,37
2300M-4	4	6.8	50	1	7,37
2300M-4.5	4.5	7.1	50	1	7,37
2300M-5	5	8	50	1	7,37
2300M-5.5	5.5	8.3	50	1	7,37
2300M-6	6	9.3	50	1	7,37
2300M-7	7	10.9	50	1	7,37
2300M-8	8	11.6	50	1	7,37
2300M-9	9	13	50	1	7,37
2300M-10	10	14.3	50	1	7,59
2300M-11	11	16	50	1	7,59
2300M-12	12	17.4	50	1	7,54
2300M-13	13	18	50	1	8,00
2300M-14	14	19	50	1	8,20



ESAGONO

CHIAVI A BUSSOLA A
MANO BOCCA ESAGONALE
SEMI LUNGHE

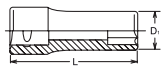

Koken articolo		D ₁ mm	L mm		Euro
2300X-4	4	6.7	32	1	7,56
2300X-5	5	8	32	1	7,56
2300X-6	6	9.2	32	1	7,56
2300X-7	7	10.5	32	1	7,56
2300X-8	8	11.8	32	1	7,56
2300X-9	9	13	32	1	7,56
2300X-10	10	14.3	32	1	7,78
2300X-11	11	15.5	32	1	7,78
2300X-12	12	16.8	32	1	7,73
2300X-13	13	18	32	1	8,20
2300X-14	14	19.3	32	1	8,42



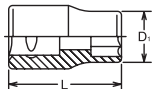

POLIGONALE
**CHIAVI A BUSSOLA A
MANO BOCCA POLIGONALE**

Koken articolo	mm	D ₁ mm	L mm		Euro
2305M-3	3	5.4	50	1	7,37
2305M-4	4	6.8	50	1	7,37
2305M-4.5	4.5	7.1	50	1	7,37
2305M-5	5	8	50	1	7,37
2305M-5.5	5.5	8.3	50	1	7,37
2305M-6	6	9.3	50	1	7,37
2305M-7	7	10.9	50	1	7,37
2305M-8	8	11.6	50	1	7,37
2305M-9	9	13	50	1	7,37
2305M-10	10	14.3	50	1	7,59
2305M-11	11	16	50	1	7,59
2305M-12	12	17.4	50	1	7,59
2305M-13	13	18	50	1	8,00
2305M-14	14	19	50	1	8,20

POLLICI

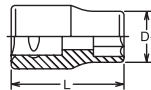

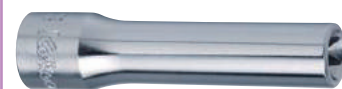

POLIGONALE
**CHIAVI A BUSSOLA A
MANO BOCCA POLIGONALE**

Koken articolo	pollici	D ₁ mm	L mm		Euro
2305A-1/8	1/8"	5.4	50	1	7,95
2305A-5/32	5/32"	6.8	50	1	7,95
2305A-3/16	3/16"	8	50	1	7,95
2305A-7/32	7/32"	8.3	50	1	7,95
2305A-1/4	1/4"	9.8	50	1	7,95
2305A-9/32	9/32"	10.9	50	1	7,95
2305A-5/16	5/16"	11.6	50	1	7,95
2305A-11/32	11/32"	13	50	1	7,95
2305A-3/8	3/8"	14.3	50	1	8,20
2305A-7/16	7/16"	16	50	1	8,20
2305A-1/2	1/2"	18	50	1	8,64
2305A-9/16	9/16"	19	50	1	8,86

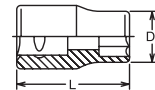

TORX®
**CHIAVI A BUSSOLA A
MANO BOCCA TORX®**

Koken articolo		D ₁ mm	L mm		Euro
2325-E 4	E 4	5.4	50	1	11,77
2325-E 5	E 5	6.8	50	1	11,77
2325-E 6	E 6	8	50	1	11,77
2325-E 7	E 7	8.3	50	1	11,77
2325-E 8	E 8	9.8	50	1	11,77
2325-E 10	E10	11.6	50	1	11,77

TORX®
S
mm
S
mm

E 4	3.70	E 16	14.60
E 5	4.60	E 18	16.50
E 6	5.60	E 20	18.30
E 7	6.10	E 22	20.10
E 8	7.40	E 24	22.00
E 10	9.30	E 26	23.70
E 11	9.90	E 28	25.50
E 12	11.00	E 30	27.30
E 14	12.80	E 32	29.00

S

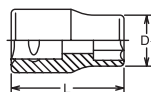

**SURFACE
DRIVE**

**CHIAVI A BUSSOLA
A MANO BOCCA
SURFACE DRIVE**

Koken articolo	mm	D ₁ mm	L mm		Euro
2310M-3	3	5.4	50	1	7,73
2310M-4	4	6.8	50	1	7,73
2310M-4.5	4.5	7.1	50	1	7,73
2310M-5	5	8	50	1	7,73
2310M-5.5	5.5	8.3	50	1	7,73
2310M-6	6	9.3	50	1	7,73
2310M-7	7	10.9	50	1	7,73
2310M-8	8	11.6	50	1	7,73
2310M-9	9	13	50	1	7,73
2310M-10	10	14.3	50	1	8,00
2310M-11	11	16	50	1	8,00
2310M-12	12	17.4	50	1	8,00
2310M-13	13	18	50	1	8,42
2310M-14	14	19	50	1	8,64

POLLICI

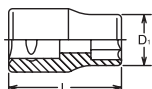

ESAGONO
**CHIAVI A BUSSOLA A
MANO BOCCA ESAGONALE**



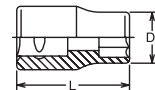

Koken articolo	pollici	D ₁ mm	L mm		Euro
2300A-1/8	1/8"	5.4	50	1	7,95
2300A-5/32	5/32"	6.8	50	1	7,95
2300A-3/16	3/16"	8	50	1	7,95
2300A-7/32	7/32"	8.3	50	1	7,95
2300A-1/4	1/4"	9.8	50	1	7,95
2300A-9/32	9/32"	10.9	50	1	7,95
2300A-5/16	5/16"	11.6	50	1	7,95
2300A-11/32	11/32"	13	50	1	7,95
2300A-3/8	3/8"	14.3	50	1	8,20
2300A-7/16	7/16"	16	50	1	8,20
2300A-1/2	1/2"	18	50	1	8,64
2300A-9/16	9/16"	19	50	1	8,86



**NUT GRIP®
BLOCCADADI**
**CHIAVI A BUSSOLA A
MANO BOCCA NUT GRIP®**

Koken articolo	mm	D ₁ mm	L mm		Euro
2350M-8	8	12.3	50	1	14,58
2350M-10	10	14.2	50	1	14,58
2350M-12	12	17.3	50	1	14,58
2350M-14	14	19.9	50	1	15,15

**SERIE 11 PZ. CHIAVI A BUSSOLA LUNGHE
MISURE: 4, 5, 6, 7, 8, 9, 10, 11, 12, 13, 14
DISPONIBILI CON BOCCA:
ESAGONALE/POLIGONALE**

Koken articolo		L mm		Euro
RS2300M/11		50	1	80,60
RS2305M/11		50	1	80,60





POLLICI



SERIE 9 PZ. CHIAVI A BUSSOLA LUNGHE
MISURE: 3/16", 7/32", 1/4", 9/32", 5/16"
11/32", 3/8", 7/16", 1/2"
DISPONIBILI CON BOCCA:
ESAGONALE/POLIGONALE

Koken articolo	mm	L mm	mm	Euro
RS2300A/9	50	1	70,32	
RS2305A/9	50	1	70,32	



ESAGONO

CHIAVI A BUSSOLA A
MANO SNODATE
BOCCA ESAGONALE

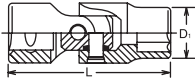

Koken articolo	mm	D ₁ mm	L mm	Euro
2440M-4	4	6.7	31.5	22,14
2440M-5	5	8	32	22,14
2440M-6	6	9.2	33	22,14
2440M-7	7	10.5	33	22,14
2440M-8	8	11.7	34	22,14
2440M-9	9	13	34	22,14
2440M-10	10	14.2	35	22,14
2440M-11	11	15.5	36	22,14
2440M-12	12	16.7	37	22,39
2440M-13	13	18	37	22,61
2440M-14	14	19.2	37	22,61

POLLICI



ESAGONO

CHIAVI A BUSSOLA A
MANO SNODATE
BOCCA ESAGONALE

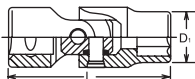

Koken articolo	pollici	D ₁ mm	L mm	Euro
2440A-1/4	1/4"	9.8	33	23,82
2440A-5/16	5/16"	11.7	34	23,82
2440A-3/8	3/8"	13.7	35	23,82
2440A-7/16	7/16"	15.5	36	23,82
2440A-1/2	1/2"	18	37	24,39
2440A-9/16	9/16"	19.2	37	24,39



POLIGONALE

CHIAVI A BUSSOLA A
MANO SNODATE
BOCCA POLIGONALE

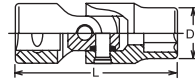

Koken articolo	mm	D ₁ mm	L mm	Euro
2445M-4	4	6.7	31.5	22,14
2445M-5	5	8	32	22,14
2445M-6	6	9.2	33	22,14
2445M-7	7	10.5	33	22,14
2445M-8	8	11.7	34	22,14
2445M-9	9	13	34	22,14
2445M-10	10	14.2	35	22,14
2445M-11	11	15.5	36	22,14
2445M-12	12	16.7	37	22,39
2445M-13	13	18	37	22,61
2445M-14	14	19.2	37	22,61

POLLICI

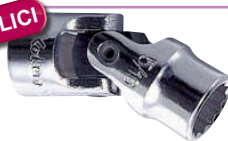

POLIGONALE

CHIAVI A BUSSOLA A
MANO SNODATE
BOCCA POLIGONALE

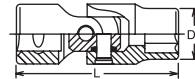

Koken articolo	pollici	D ₁ mm	L mm	Euro
2445A-3/16	3/16"	8	32	23,82
2445A-1/4	1/4"	9.8	33	23,82
2445A-9/32	9/32"	10.5	33	23,82
2445A-5/16	5/16"	11.7	34	23,82
2445A-11/32	11/32"	13	34	23,82
2445A-3/8	3/8"	13.7	35	23,82
2445A-7/16	7/16"	15.5	36	23,82
2445A-1/2	1/2"	18	37	24,39
2445A-9/16	9/16"	19.2	37	24,39



TORX®

CHIAVI A BUSSOLA A
MANO SNODATE
BOCCA TORX®

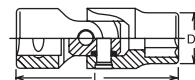

Koken articolo	pollici	D ₁ mm	L mm	Euro
2440T-E 6	E 6	8.0	31.9	28,33
2440T-E 8	E 8	9.8	33.1	28,33
2440T-E10	E10	11.7	33.6	28,33
2440T-E12	E12	14.2	35.1	28,33



NUT GRIP®
BLOCCADADI

CHIAVI A BUSSOLA A
MANO SNODATE
BOCCA NUT GRIP®

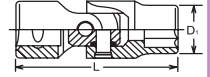

Koken articolo	mm	D ₁ mm	L mm	Euro
2441M-7	7	11.3	33	27,12
2441M-8	8	12.3	32	27,12
2441M-10	10	14.5	32.5	27,23
2441M-12	12	16.8	34	27,64
2441M-13	13	18.0	35	27,64
2441M-14	14	20.0	37	27,64



PHILLIPS®

CHIAVI A BUSSOLA A
CROCE PHILLIPS®



Koken articolo	mm	D mm	L mm	Euro
2000-28 (PH)-1	PH1	12	28	7,95
2000-28 (PH)-2	PH2	12	28	7,95
2000-28 (PH)-3	PH3	12	28	7,95
2000-28 (PH)-4	PH4	13.1	28	7,95



POZIDRIV®

CHIAVI A BUSSOLA A
CROCE POZIDRIV®

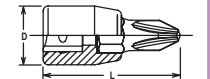

Koken articolo	mm	D mm	L mm	Euro
2000-28 (PZ)-1	PZ1	12	28	9,05
2000-28 (PZ)-2	PZ2	12	28	9,05
2000-28 (PZ)-3	PZ3	12	28	9,05



TAGLIO

CHIAVI A BUSSOLA
A TAGLIO

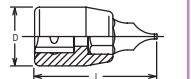

Koken articolo	mm	D mm	L mm	Euro
2005-25-3	0.5x 3	12	25	6,85
2005-25-4	0.8x 4	12	25	6,85
2005-25-5	1.0x 5.5	12	25	6,85
2005-25-6	1.2x 6.5	13.1	25	6,85
2005-25-8	1.2x 8	13.1	25	6,85
2005-25-9	1.6x 8	13.1	25	6,85
2005-25-10	1.6x 10	14.3	25	6,85

KOKEN 1/4"



ESAGONO

CHIAVI A BUSSOLA MASCHIO ESAGONALE

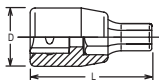

Koken articolo	mm	D mm	L mm		Euro
2010M-25-1.5	1.5	11.9	25	1	6,24
2010M-25-2	2	11.9	25	1	6,24
2010M-25-2.5	2.5	11.9	25	1	6,24
2010M-25-3	3	11.9	25	1	6,24
2010M-25-4	4	11.9	25	1	6,24
2010M-25-5	5	11.9	25	1	6,24
2010M-25-6	6	11.9	25	1	6,24
2010M-25-7	7	13.1	25	1	6,24
2010M-25-8	8	13.1	25	1	6,24
2010M-25-10	10	14.3	25	1	6,24
2010M-25-12	12	16.4	25	1	11,30
2010M-100-2	2	11.9	100	1	9,30
2010M-100-2.5	2.5	11.9	100	1	9,30
2010M-100-3	3	11.9	100	1	9,30
2010M-100-4	4	11.9	100	1	9,30
2010M-100-5	5	13.1	100	1	9,30
2010M-100-6	6	13.1	100	1	9,30
2010M-100-7	7	13.1	100	1	9,30
2010M-100-8	8	13.1	100	1	9,30
2010M-100-10	10	14.3	100	1	9,30
2010M-100-12	12	16.4	100	1	17,19



ESAGONO

CHIAVI A BUSSOLA MASCHIO ESAGONALE TESTA SFERICA



Koken articolo	mm	D mm	L mm		Euro
2011M-50-3	3	12	50	1	9,98
2011M-50-4	4	12	50	1	9,98
2011M-50-5	5	12	50	1	9,98
2011M-50-6	6	12	50	1	9,98



XZN

CHIAVI A BUSSOLA MASCHIO XZN

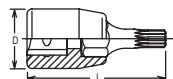

Koken articolo		D mm	L mm		Euro
2020-28-M4	M 4	12	28	1	9,52
2020-28-M5	M 5	12	28	1	9,52
2020-28-M6	M 6	12	28	1	9,52
2020-28-M8	M 8	13.1	28	1	9,52
2020-50-M4	M 4	12	50	1	11,08
2020-50-M5	M 5	12	50	1	11,08
2020-50-M6	M 6	12	50	1	11,08
2020-50-M8	M 8	13.1	50	1	11,08

XZN	S mm	S mm	
M 4	3,60	M12	11,50
M 5	4,80	M14	13,30
M 6	6,10	M16	15,70
M 8	7,30	M18	16,90
M10	9,70		

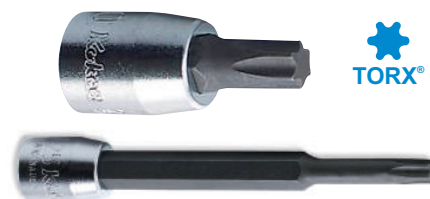

TORX®

CHIAVI A BUSSOLA MASCHIO TORX®

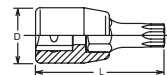

Koken articolo		D mm	L mm		Euro
2025-28-T8	TX 8	12	28	1	8,69
2025-28-T9	TX 9	12	28	1	8,69
2025-28-T10	TX 10	12	28	1	8,69
2025-28-T15	TX 15	12	28	1	8,69
2025-28-T20	TX 20	12	28	1	8,69
2025-28-T25	TX 25	12	28	1	8,69
2025-28-T27	TX 27	12	28	1	8,69
2025-28-T30	TX 30	12	28	1	8,69
2025-28-T40	TX 40	12	28	1	8,69
2025-80-T10	TX 10	12	80	1	11,25
2025-80-T15	TX 15	12	80	1	11,25
2025-80-T20	TX 20	12	80	1	11,25
2025-80-T25	TX 25	12	80	1	11,25
2025-80-T27	TX 27	12	80	1	11,25
2025-80-T30	TX 30	12	80	1	11,25
2025-80-T40	TX 40	12	80	1	12,73

TORX®	S mm	S mm	
T 6	1.70	T 40	6.70
T 7	2.00	T 45	7.90
T 8	2.30	T 50	8.90
T 9	2.50	T 55	11.30
T 10	2.70	T 60	13.30
T 15	3.30	T 70	15.60
T 20	3.90	T 80	17.60
T 25	4.50	T 90	20.00
T 27	5.00	T 100	22.20
T 30	5.60		

POLLICI



ESAGONO

CHIAVI A BUSSOLA MASCHIO ESAGONALE

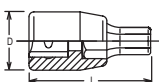

Koken articolo	pollici	D mm	L mm		Euro
2010A-25-1/8	1/8"	12	25	1	6,74
2010A-25-5/32	5/32"	12	25	1	6,74
2010A-25-3/16	3/16"	12	25	1	6,74
2010A-25-7/32	7/32"	12	25	1	6,74
2010A-25-1/4	1/4"	12	25	1	6,74
2010A-25-9/32	9/32"	13.1	25	1	6,74
2010A-25-5/16	5/16"	13.1	25	1	6,74
2010A-25-3/8	3/8"	14.3	25	1	6,74



TORX® CON FORO

CHIAVI A BUSSOLA MASCHIO TORX® CON FORO

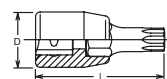

Koken articolo		D mm	L mm		Euro
2025-28-T10H	TH 10	12	28	1	9,74
2025-28-T15H	TH 15	12	28	1	9,74
2025-28-T20H	TH 20	12	28	1	9,74
2025-28-T25H	TH 25	12	28	1	9,74
2025-28-T27H	TH 27	12	28	1	9,74
2025-28-T30H	TH 30	12	28	1	9,74
2025-28-T40H	TH 40	12	28	1	9,74



CHIAVI A BUSSOLA MASCHIO TORX PLUS®

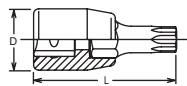

Koken articolo		D mm	L mm		Euro
2025-28-8IP	8IP	12	28	1	11,80
2025-28-9IP	9IP	12	28	1	11,80
2025-28-10IP	10IP	12	28	1	11,80
2025-28-15IP	15IP	12	28	1	11,80
2025-28-20IP	20IP	12	28	1	11,80
2025-28-25IP	25IP	12	28	1	11,80
2025-28-27IP	27IP	12	28	1	11,80
2025-28-30IP	30IP	12	28	1	11,80
2025-28-40IP	40IP	12	28	1	11,80



SERIE 7 PZ. CHIAVI A BUSSOLA MASCHIO ESAGONALE ESAGONO

Koken articolo		mm	L mm		Euro
RS2010M/7-L25		3, 4, 5, 6, 7, 8, 10	25	1	42,08

POLLICI



SERIE 8 PZ. CHIAVI A BUSSOLA MASCHIO ESAGONALE ESAGONO

Koken articolo		mm	L mm		Euro
RS2010A/8-L25		1/8, 5/32, 3/16, 7/32, 1/4, 9/32, 5/16, 3/8	25	1	51,92



SERIE 7 PZ. CHIAVI A BUSSOLA MASCHIO TORX®

Koken articolo		L mm		Euro
RS2025/7-L28		TX10, TX15, TX20, TX25, TX27, TX30, TX40	1	58,52



SERIE 7 PZ. CHIAVI A BUSSOLA MASCHIO TORX® CON FORO

Koken articolo		L mm		Euro
RS2025/7-L28(TH)		TH10, TH15, TH20, TH25, TH27, TH30, TH40	1	65,48



SERIE 7 PZ. CHIAVI A BUSSOLA MASCHIO TORX PLUS®

Koken articolo		L mm		Euro
RS2025/7(IP)		10IP, 15IP, 20IP, 25IP, 27IP, 30IP, 40IP	1	78,82



PENTALOBATA CON FORO

SERIE 7 PZ. CHIAVI A BUSSOLA MASCHIO PENTALOBATO CON FORO

Koken articolo		L mm		Euro
RS2025/7(PR)		10PR, 15PR, 20PR, 25PR, 27PR, 30PR, 40PR	1	86,32



ESAGONO

CHIAVI A BUSSOLA SNODATE MASCHIO ESAGONALE

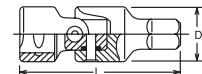

Koken articolo		D mm	L mm		Euro
2430M-3	3	13	40	1	24,56
2430M-4	4	13	40	1	24,56
2430M-5	5	13	40	1	24,56
2430M-6	6	13	40	1	24,56



TORX®

CHIAVI A BUSSOLA SNODATE MASCHIO TORX®

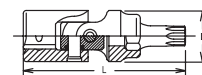

Koken articolo		D mm	L mm		Euro
2430T-T 8	TX 8	13	42	1	29,56
2430T-T 9	TX 9	13	42	1	29,56
2430T-T10	TX 10	13	42	1	29,56
2430T-T15	TX 15	13	42	1	29,56
2430T-T20	TX 20	13	42	1	29,56
2430T-T25	TX 25	13	42	1	29,56
2430T-T27	TX 27	13	42	1	29,56
2430T-T30	TX 30	13	42	1	29,56



S mm

	S mm	S mm
8 IP	2.30	30 IP 5.60
9 IP	2.50	40 IP 6.70
10 IP	2.70	45 IP 7.90
15 IP	3.30	50 IP 8.90
20 IP	3.90	55 IP 11.30
25 IP	4.50	60 IP 13.30
27 IP	5.00	



PENTALOBATA CON FORO

CHIAVI A BUSSOLA MASCHIO PENTALOBATO CON FORO

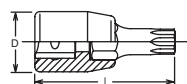

Koken articolo		D	L mm		Euro
2025-28-8PR	8PR	12	28	1	12,68
2025-28-9PR	9PR	12	28	1	12,68
2025-28-10PR	10PR	12	28	1	12,68
2025-28-15PR	15PR	12	28	1	12,68
2025-28-20PR	20PR	12	28	1	12,68
2025-28-25PR	25PR	12	28	1	12,68
2025-28-27PR	27PR	12	28	1	12,68
2025-28-30PR	30PR	12	28	1	12,68
2025-28-40PR	40PR	12	28	1	12,68

PENTALOBATA

S mm

	S mm	S mm
8 PR	2.20	27 PR 4.70
9 PR	2.40	30 PR 5.20
10 PR	2.60	40 PR 6.30
15 PR	3.10	45 PR 7.40
20 PR	3.60	50 PR 8.40
25 PR	4.10	55 PR 10.60



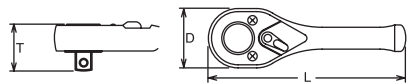

 MECCANISMO
20
DENTI

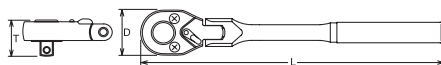
**CRICCHETTO PORTABUSSOLA REVERSIBILE
SERIE CORTA**

Koken articolo	D mm	T mm	L mm		Euro
2753PS	22	18.7	75	1	43,07

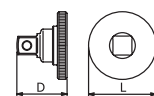

 MECCANISMO
20
DENTI

**CRICCHETTO PORTABUSSOLA
REVERSIBILE SNODATO**

Koken articolo	D mm	T mm	L mm		Euro
2774JS	22	18.7	116	1	71,89

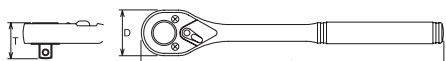

 MECCANISMO
44
DENTI

ADATTATORE A MANOPOLA PORTA BUSSOLA

Koken articolo	D mm	L mm		Euro
2756	26	22	1	15,54

 MECCANISMO
20
DENTI

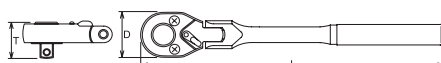
CRICCHETTO PORTABUSSOLA REVERSIBILE

Koken articolo	D mm	T mm	L mm		Euro
2753J	22	18.7	115	1	40,62

 MECCANISMO
20
DENTI

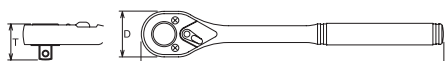
**CRICCHETTO PORTABUSSOLA
REVERSIBILE SNODATO**

Koken articolo	D mm	T mm	L mm		Euro
2774PS	22	18.7	116	1	71,28

 MECCANISMO
20
DENTI

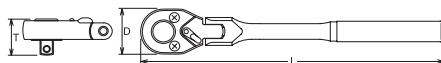
CRICCHETTO PORTABUSSOLA REVERSIBILE

Koken articolo	D mm	T mm	L mm		Euro
2753P	22	18.7	115	1	41,03
2753P-160	22	18.7	160	1	56,73

 MECCANISMO
20
DENTI

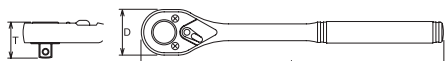
**CRICCHETTO PORTABUSSOLA
REVERSIBILE SNODATO**

Koken articolo	D mm	T mm	L mm		Euro
2774J	22	18.7	161	1	75,41

 MECCANISMO
20
DENTI

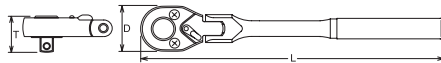
**CRICCHETTO PORTABUSSOLA REVERSIBILE
CON PULSANTE DI SBLOCCAGGIO RAPIDO**

Koken articolo	D mm	T mm	L mm		Euro
2753JB	22	18.7	115	1	49,75

 MECCANISMO
20
DENTI

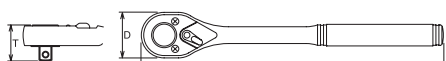
**CRICCHETTO PORTABUSSOLA
REVERSIBILE SNODATO**

Koken articolo	D mm	T mm	L mm		Euro
2774P	22	18.7	161	1	72,90

 MECCANISMO
20
DENTI

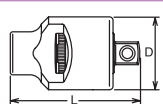
**CRICCHETTO PORTABUSSOLA REVERSIBILE
CON PULSANTE DI SBLOCCAGGIO RAPIDO**

Koken articolo	D mm	T mm	L mm		Euro
2753PB	22	18.7	115	1	49,12

 MECCANISMO
44
DENTI

ADATTATORE CON CRICCHETTO

Koken articolo	D mm	L mm		Euro
2755	26	40	1	49,75



PROLUNGHE

Koken articolo	D mm	L mm		Euro
2760-28	12.3	28	1	8,53
2760-50	12.3	50	1	8,53
2760-75	12.3	75	1	10,34
2760-100	12.3	100	1	10,34
2760-150	12.3	150	1	11,96
2760-200	12.3	200	1	16,09
2760-250	12.3	250	1	16,09
2760-300	12.3	300	1	19,69
2760-350	12.3	350	1	24,83
2760-400	12.3	400	1	25,38
2760-600	12.3	600	1	34,38

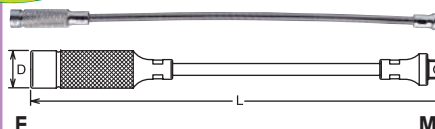

SERIE 6 PZ. PROLUNGHE

Koken articolo	L mm		Euro
PK2760/6	28, 50, 100, 150, 200, 250	1	83,77

FLEX

PROLUNGA FLESSIBILE

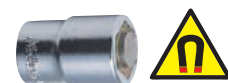
Koken articolo	D mm	L mm		Euro
2762-300	13	300	1	28,27

TESTA MAGNETICA

Koken articolo	L mm		Euro
2120	23	1	12,18



TESTA SFERICA

PROLUNGHE A TESTA SFERICA INCLINAZIONE MASSIMA 15°

SISTEMA WOBBLE-FIX CON DUE MODALITÀ DI UTILIZZO:

- PROLUNGA TESTA SFERICA MAX 15°
- PROLUNGA TRADIZIONALE

Wobble
Fix

Koken articolo	D mm	L mm	Box	Euro
2763-28	12.3	28	1	10,29
2763-50	12.3	50	1	12,07
2763-75	12.3	75	1	12,57
2763-100	12.3	100	1	14,30
2763-150	12.3	150	1	18,45
2763-200	12.3	200	1	19,50
2763-250	12.3	250	1	21,95

1/4"

IMPUGNATURE PORTA BUSSOLE

attacco: 1/4"

Koken articolo	1/4"	L mm	Box	Euro
2769 N-150	1/4"	150	1	12,62
2769 N-220	1/4"	220	1	14,36

SNODO

Koken articolo	L mm	Box	Euro
2770	33	1	18,92

TESTA SFERICA

PROLUNGHE A TESTA SFERICA INCLINAZIONE MASSIMA 15°

SISTEMA WOBBLE-FIX CON DUE MODALITÀ DI UTILIZZO:

- PROLUNGA TESTA SFERICA ANGOLO 15°
- PROLUNGA TRADIZIONALE

Wobble
Fix

Koken articolo	L mm	Box	Euro
PK2763/6	28, 50, 100, 150, 200, 250	1	110,08

TESTA SFERICA

1/4"

IMPUGNATURE A TESTA SFERICA PORTA BUSSOLE

SISTEMA WOBBLE-FIX CON DUE MODALITÀ DI UTILIZZO:

- PROLUNGA TESTA SFERICA ANGOLO 15°
- PROLUNGA TRADIZIONALE

Wobble
Fix

attacco: 1/4"

Koken articolo	1/4"	L mm	Box	Euro
2769 NWF-150	1/4"	150	1	13,48
2769 NWF-220	1/4"	220	1	14,91

SNODO

Koken articolo	L mm	Box	Euro
2771	31	1	23,16

QUADRO MASCHIO CON MANOVELLA

Koken articolo	H mm	L mm	Box	Euro
2780	65	350	1	26,70

QUADRO MASCHIO SNODATO CON IMPUGNATURA

Koken articolo	D mm	L mm	Box	Euro
2768J	14	130	1	26,07

QUADRO MASCHIO PIEGHEVOLE 90° CON IMPUGNATURA

Koken articolo	L mm	Box	Euro
2769H	160	1	48,13

1/4"

CHIAVI A "T" MASCHIO QUADRO 1/4" LARGHEZZA IMPUGNATURA 120 MM

Koken articolo	1/4"	L mm	Box	Euro
2715-1/4	1/4"	200	1	20,02

QUADRO MASCHIO SNODATO CON IMPUGNATURA IN METALLO

Koken articolo	D mm	L mm	Box	Euro
2768P	14	130	1	26,76

QUADRO MASCHIO CON ASTA SCORREVOLE

Koken articolo	L mm	Box	Euro
2785	115	1	11,25





1/4" **3/8"**

RACCORDO DI RIDUZIONE QUADRO MASCHIO 3/8" E FEMMINA 1/4"





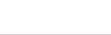

Koken articolo	L mm	Box	Euro
2233A	22	1	7,89

KOKEN 1/4"

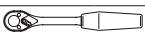









Koken articolo	DESCRIZIONE	Euro
ESH2001	Cassetta metallica 16 Pz. 310 x 86 x h 28 mm	140,33
RICAMBI		
BUSSOLE		
 SURFACE DRIVE	2410M	4, 5, 5.5, 6, 7, 8, 9, 10, 11, 12, 13
ACCESSORI	2753J	
	2763-50	
	2760-150	
	2770	
	2785	





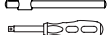
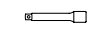







Koken articolo	DESCRIZIONE	Euro
2251M	Cassetta metallica 17 Pz. 192 x 122 x h 30 mm	163,54
RICAMBI		
BUSSOLE		
 ESAGONO	2400M	4, 4.5, 5, 5.5, 6, 7, 8, 9, 10, 11, 13
ACCESSORI	2753J	
	2760-50	
	2760-150	
	2768J	
	2770	
	2785	

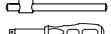







Koken articolo	DESCRIZIONE	Euro
2258M	Cassetta metallica 31 Pz. 240 x 100 x h 32 mm	254,21
RICAMBI		
BUSSOLE		
 ESAGONO	2400M	4, 4.5, 5, 5.5, 6, 7, 8, 9, 10, 11, 13
BUSSOLE		
	2000.28	1, 2, 3
BUSSOLE		
	2005.25	4, 6
BUSSOLE		
	2010M.25	3, 4, 5, 6, 8
BUSSOLE		
	2025.28	T10, T15, T20, T25, T30
ACCESSORI	2753J	
	2785	
	2769N-150	
	2760-100	
	2770	

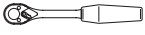

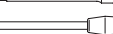







Koken articolo	DESCRIZIONE	Euro
ENH2003	Cassetta metallica 26 Pz. 310 x 86 x h 40 mm	193,02
RICAMBI		
BUSSOLE		
 ESAGONO	2400M	5.5, 6, 7, 8, 9, 10, 11, 12, 13, 14
BUSSOLE		
	2000.28	1, 2
BUSSOLE		
	2005.25	4, 6, 8
BUSSOLE		
	2010M.25	3, 4, 5, 6
ACCESSORI	2753J	
	2785	
	2769N-150	
	2760-50	
	2760-150	
	2770	
	2137	

POLLICI

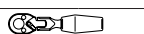
Koken articolo	DESCRIZIONE	Euro
2251A	Cassetta metallica 15 Pz. 192 x 122 x h 30 mm	163,54
RICAMBI		
BUSSOLE		
 ESAGONO	2400A	3/16", 7/32", 1/4", 9/32", 5/16", 11/32", 3/8", 7/16", 1/2"
ACCESSORI	2753J	
	2760-50	
	2760-150	
	2768J	
	2770	
	2785	



Koken articolo	DESCRIZIONE	Euro
2259M	Cassetta metallica 31 Pz. 240 x 100 x h 32 mm CON CRICCHETTO SNODATO	285,92
RICAMBI		
BUSSOLE		
 ESAGONO	2400M	4, 4.5, 5, 5.5, 6, 7, 8, 9, 10, 11, 13
BUSSOLE		
	2000.28	1, 2, 3
BUSSOLE		
	2005.25	4, 6
BUSSOLE		
	2010M.25	3, 4, 5, 6, 8
BUSSOLE		
	2025.28	T10, T15, T20, T25, T30
ACCESSORI	2774JS	
	2760-100	
	2769N-150	
	2770	
	2785	

SOLES
GO FER MEC
AUTOMOTIVE INDUSTRIAL TOOLS



Koken articolo	DESCRIZIONE	Euro
2277	Cassetta metallica 21 Pz. 310 x 86 x h 50 mm	182,05
RICAMBI		
BUSSOLE ESAGONO	2400M	5.5, 6, 7, 8, 9, 10, 11, 12, 13
	2300M	5.5, 6, 7, 8, 9, 10, 11, 12, 13
ACCESSORI	2753J	
	2763-75	
	2769N-150	



Koken articolo	DESCRIZIONE	Euro
2275	Cassetta metallica 19 Pz. 192 x 122 x h 30 mm	163,85
RICAMBI		
BUSSOLE ESAGONO	2400M	5.5, 6, 7, 8, 10, 12, 13
	2000.28	1, 2, 3
BUSSOLE	2005.25	6, 8
BUSSOLE	2010M.25	3, 4, 5, 6
ACCESSORI	2753J	
	2763-50	
	2769N-150	



Koken articolo	DESCRIZIONE	Euro
P2251M	Cassetta plastica 18 Pz. 245 x 120 x h 45 mm	169,68
RICAMBI		
BUSSOLE ESAGONO	2400M	4, 5, 5.5, 6, 7, 8, 9, 10, 11, 12, 13
	2753J	
ACCESSORI	2760-50	
	2760-150	
	2768J	
	2770	
2785		



Koken articolo	DESCRIZIONE	Euro
2276	Cassetta metallica 19 Pz. 192 x 122 x h 30 mm	140,20
RICAMBI		
INSERTI	108P	1, 2, 3
INSERTI	108S	4, 5, 6
INSERTI	108H	3, 4, 5, 6
INSERTI	108T	T10, T15, T20, T25, T30
ACCESSORI	2137	
	2753PS	
	2769N-150	

MILLIMETRI E POLLICI



Koken articolo	DESCRIZIONE	Euro
P2201AM	Cassetta plastica 25 Pz. 245 x 120 x h 45 mm	176,22
RICAMBI		
BUSSOLE ESAGONO	2400M	4, 5, 5.5, 6, 7, 8, 9, 10, 11, 12, 13
	2400A	3/16", 7/32", 1/4", 9/32", 5/16", 11/32", 3/8", 7/16", 1/2"
ACCESSORI	2753J	
	2760-100	
	2769N-150	
	2770	
2785		



Koken articolo	DESCRIZIONE	Euro
P2258M	Cassetta plastica 31 Pz. 245 x 120 x h 45 mm	253,41
RICAMBI		
BUSSOLE ESAGONO	2400M	4, 5, 5.5, 6, 7, 8, 9, 10, 11, 12, 13
	2000.28	1, 2, 3
BUSSOLE	2005.25	4, 6
BUSSOLE	2010M.25	3, 4, 5, 6, 8
BUSSOLE	2025.28	T10, T15, T20, T25, T30
ACCESSORI	2753J	
	2760-100	
	2769N-150	
	2770	
2785		



SET KOKEN 1/4"



BUSSOLE CHROM-VANADIUM - SATINATE

 Attacco: 1/4"
 impronta: ESAGONO

BGS articolo	mm	L mm		Euro
BGS 2473	3,5	25	1	1,58
BGS 2474	4	25	1	1,58
BGS 2475	4,5	25	1	1,58
BGS 2476	5	25	1	1,58
BGS 2477	5,5	25	1	1,58
BGS 2478	6	25	1	1,58
BGS 2479	7	25	1	1,58
BGS 2480	8	25	1	1,79
BGS 2481	9	25	1	1,79
BGS 2482	10	25	1	2,00
BGS 2483	11	25	1	2,00
BGS 2484	12	25	1	2,00
BGS 2485	13	25	1	2,31
BGS 2486	14	25	1	2,52



BUSSOLE CHROM-VANADIUM SATINATE, POLIGONALI

 Attacco: 1/4"
 impronta: POLIGONALE

BGS articolo	mm	L mm		Euro
BGS 10774	4	25	1	1,91
BGS 10773	4,5	25	1	1,91
BGS 10775	5	25	1	1,91
BGS 10772	5,5	25	1	1,91
BGS 10776	6	25	1	1,91
BGS 10777	7	25	1	1,91
BGS 10778	8	25	1	1,91
BGS 10779	9	25	1	1,91
BGS 10780	10	25	1	2,04
BGS 10781	11	25	1	2,04
BGS 10782	12	25	1	2,17
BGS 10783	13	25	1	2,30
BGS 10784	14	25	1	2,42

BUSSOLE CHROM-VANADIUM - SATINATE SURFACE DRIVE

 Attacco: 1/4"
 impronta: SURFACE-DRIVE

BGS articolo	mm	L mm		Euro
BGS 2344	4	25	1	1,53
BGS 2339	4,5	25	1	1,53
BGS 2345	5	25	1	1,53
BGS 2343	5,5	25	1	1,53
BGS 2346	6	25	1	1,53
BGS 2347	7	25	1	1,53
BGS 2348	8	25	1	1,66
BGS 2349	9	25	1	1,66
BGS 2350	10	25	1	1,66
BGS 2351	11	25	1	1,79
BGS 2352	12	25	1	1,79
BGS 2353	13	25	1	1,79
BGS 2354	14	25	1	2,30

POLLICI

BUSSOLE CHROM-VANADIUM - SATINATE IN POLLICI

 Attacco: 1/4"
 impronta: ESAGONO

BGS articolo	pollici	L mm		Euro
BGS 10650	5/32"	25	1	1,91
BGS 10651	3/16"	25	1	2,04
BGS 10652	7/32"	25	1	2,04
BGS 10653	1/4"	25	1	2,04
BGS 10654	9/32"	25	1	2,04
BGS 10655	5/16"	25	1	2,04
BGS 10656	11/32"	25	1	2,42
BGS 10657	3/8"	25	1	2,42
BGS 10658	7/16"	25	1	2,42
BGS 10659	1/2"	25	1	2,55

POLLICI

BUSSOLE CHROM-VANADIUM - SATINATE POLIGONALI - IN POLLICI

 Attacco: 1/4"
 impronta: POLIGONALE

BGS articolo	pollici	L mm		Euro
BGS 10870	5/32"	25	1	1,28
BGS 10871	3/16"	25	1	1,28
BGS 10872	7/32"	25	1	1,28
BGS 10873	1/4"	25	1	1,40
BGS 10874	9/32"	25	1	1,40
BGS 10875	5/16"	25	1	1,40
BGS 10876	11/32"	25	1	1,40
BGS 10877	3/8"	25	1	1,40
BGS 10878	7/16"	25	1	1,53
BGS 10879	15/32"	25	1	1,53
BGS 10880	1/2"	25	1	1,66
BGS 10881	9/16"	25	1	1,79

NEW

BUSSOLE SERIE TORX® AL CHROM-VANADIUM

 attacco: 1/4"
 impronta: TORX®

BGS articolo	TORX	L mm		Euro
BGS 6404	E 4	25	1	2,88
BGS 6405	E 5	25	1	2,88
BGS 6406	E 6	25	1	2,88
BGS 6407	E 7	25	1	2,88
BGS 6408	E 8	25	1	2,88
BGS 6430	E 10	25	1	2,88
BGS 6431	E 11	25	1	2,88

TORX®	S mm	S mm	
E 4	3.70	E 16	14.60
E 5	4.60	E 18	16.50
E 6	5.60	E 20	18.30
E 7	6.10	E 22	20.10
E 8	7.40	E 24	22.00
E 10	9.30	E 26	23.70
E 11	9.90	E 28	25.50
E 12	11.00	E 30	27.30
E 14	12.80	E 32	29.00

BUSSOLE MULTIMPRONTA SPLINE DRIVE



MULTIMPRONTA SPLINE DRIVE

1/4"

mm Pollici Torx® XZN®

BUSSOLE CHROM-VANADIUM MULTIMPRONTA "SPLINE DRIVE"

Attacco: 1/4"
impronta: SPLINE DRIVE

BGS articolo	mm	L mm		Euro
BGS 10104	4	25	1	2,17
BGS 10101	4,5	25	1	2,04
BGS 10105	5	25	1	2,17
BGS 10102	5,5	25	1	2,17
BGS 10106	6	25	1	2,17
BGS 10107	7	25	1	2,17
BGS 10108	8	25	1	2,17
BGS 10109	9	25	1	2,17
BGS 10110	10	25	1	2,30
BGS 10111	11	25	1	2,55
BGS 10112	12	25	1	2,55
BGS 10113	13	25	1	2,81
BGS 10114	14	25	1	2,81

NEW



1/4"   

BGS articolo	DESCRIZIONE	Euro
BGS 9102	SET 13 PEZZI, BUSSOLE ESAGONALI 4-14 MM, ATT. 1/4"	14,28

CARATTERISTICHE

- misure: 4-4,5-5-5,5-6-7-8-9- 10-11-12-13-14 mm
- finitura cromata satinata
- zigrinate
- su guida metallica



1/4" 

BGS articolo	DESCRIZIONE	Euro
BGS 2269	SET 13 PEZZI, BUSSOLE POLIGONALI 4-14 MM, ATT. 1/4"	19,64

CARATTERISTICHE

- misure: 4 - 4,5 - 5 - 5,5 - 6 - 7 - 8 - 9 - 10 - 11 - 12 - 13 - 14 mm
- su guida metallica

NEW



1/4"   

BGS articolo	DESCRIZIONE	Euro
BGS 220	SET 10 PEZZI, BUSSOLE ESAGONALI SNODATE 5-13 MM, ATT. 1/4"	52,28

CARATTERISTICHE

- misure: 5 - 5,5 - 6 - 7 - 8 - 9 - 10 - 11 - 12 - 13 mm
- finitura cromata lucida
- su guida metallica

POLLICI



1/4" 

BGS articolo	DESCRIZIONE	Euro
BGS 2755	SET 12 PEZZI, BUSSOLE POLIGONALI IN POLLICI	19,13

CARATTERISTICHE

- poligonali
- 5/32", 3/16", 7/32", 1/4", 9/32", 5/16", 11/32", 3/8", 7/16", 15/32", 1/2", 9/16"
- finitura satinata cromata

BUSSOLE MULTIMPRONTA SPLINE DRIVE



MULTIMPRONTA SPLINE DRIVE

1/4"

BGS articolo	DESCRIZIONE	Euro
BGS 2150	SET 13 PEZZI, BUSSOLE ATT. 1/4" MULTIMPRONTA	16,58

CARATTERISTICHE

- lo speciale profilo "multimpronta" consente l'uso universale Torx (E5-E18), in misure metriche (4-14 mm) ed in pollici (5/32"-1/2")
- su guida metallica

POLLICI



1/4"   

BGS articolo	DESCRIZIONE	Euro
BGS 2433	SET 11 PEZZI, BUSSOLE ATT. 1/4", IN POLLICI	13,26

CARATTERISTICHE

- esagonali
- 3/16", 7/32", 1/4", 9/32", 5/16", 11/32", 3/8", 13/32", 7/16", 15/32", 1/2"
- finitura cromata satinata
- su guida metallica

NEW



1/4"   

BGS articolo	DESCRIZIONE	Euro
BGS 6402	SET 7 PEZZI, BUSSOLE TORX FEMMINA, E4 - E11, ATT. 1/4"	11,22

CARATTERISTICHE

- zigrinate
- su guida metallica
- finitura cromata satinata
- misure: E4 - E5 - E6 - E7 - E8 - E10 - E11



NEW



BGS articolo	DESCRIZIONE	Euro
BGS 9548	SET 10 PEZZI, BUSSOLE TORX FEMMINA, E4 - E16, ATT. 1/4" E 3/8"	11,44

CARATTERISTICHE

- zigrinate
- su guida metallica
- finitura cromata satinata
- misure:
 - attacco 1/4": E4 - E5 - E6 - E7 - E8
 - attacco 3/8": E10 - E11 - E12 - E14 - E16

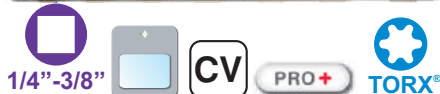

BGS articolo	DESCRIZIONE	Euro
BGS 2027	SET 7 PEZZI, BUSSOLE ATT. 1/4" + 3/8", TORX	13,26

CARATTERISTICHE

- comprende:
 - att. 1/4": E6 - E7 - E8
 - att. 3/8": E10 - E12 - E14 - E16
- finitura cromata satinata

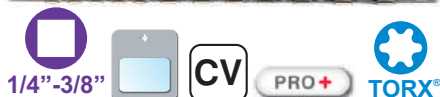

BGS articolo	DESCRIZIONE	Euro
BGS 2038	SET 12 PEZZI, BUSSOLE ATT. 1/4" + 3/8", TORX	21,17

CARATTERISTICHE

- finitura cromata satinata
- attacco 1/4": E 4-5-6-7-8
- attacco 3/8": E 10-11-12-14-16-18-20



NEW



BGS articolo	DESCRIZIONE	Euro
BGS 9588	SET 6 PEZZI, BUSSOLE TORX PLUS ATT. 1/4", 6EPL - 12EPL	24,23

CARATTERISTICHE

- misure:
 - 6 EPL - 7 EPL - 8 EPL - 10 EPL - 11 EPL - 12 EPL
- su guida metallica

TORX PLUS®

	S mm	S mm	
E 4	3.70	E 16	14.60
E 5	4.60	E 18	16.50
E 6	5.60	E 20	18.30
E 7	6.10	E 22	20.10
E 8	7.40	E 24	22.00
E 10	9.30	E 26	23.70
E 11	9.90	E 28	25.50
E 12	11.00	E 30	27.30
E 14	12.80	E 32	29.00



LUNGHE - SATINATE

Attacco: 1/4"
impronta: ESAGONO

BGS articolo	mm	L mm	Euro
BGS 10504	4	50	3,20
3720-0045	4,5	50	3,20
BGS 10505	5	50	3,20
BGS 10503	5,5	50	3,20
BGS 10506	6	50	3,20
BGS 10507	7	50	3,20
BGS 10508	8	50	3,20
BGS 10509	9	50	3,20
BGS 10510	10	50	3,20
BGS 10511	11	50	3,60
BGS 10512	12	50	3,60
BGS 10513	13	50	3,90
BGS 10514	14	50	4,30

POLLICI

LUNGHE - SATINATE
IN POLLICIAttacco: 1/4"
impronta: ESAGONO

BGS articolo	pollici	L mm	Euro
BGS 10670	1/4"	50	2,80
BGS 10671	5/16"	50	2,80
BGS 10672	3/8"	50	2,81
BGS 10673	7/16"	50	3,06
BGS 10674	1/2"	50	3,19

BUSSOLE CHROM-VANADIUM - SATINATE
LUNGHE - SURFACE DRIVEAttacco: 1/4"
impronta: SURFACE-DRIVE

BGS articolo	mm	L mm	Euro
BGS 2964	4	50	2,60
BGS 2965	5	50	2,60
BGS 2966	6	50	2,60
BGS 2967	7	50	2,60
BGS 2968	8	50	2,60
BGS 2969	9	50	2,60
BGS 2970	10	50	2,60
BGS 2971	11	50	2,60
BGS 2972	12	50	2,60
BGS 2973	13	50	2,68
BGS 2974	14	50	2,81



1/4"



TORX®



TORX® LUNGHE

attacco: 1/4"

impronta: TORX®

FE-ARTICOLA	mm	L mm	Impronta	Euro
3723-0040	E 4	50	1	6,83
3723-0050	E 5	50	1	6,83
3723-0060	E 6	50	1	6,83
3723-0070	E 7	50	1	6,83
3723-0080	E 8	50	1	6,83
3723-0100	E 10	50	1	6,83

BUSSOLE MULTIMPRONTA SPLINE DRIVE



1/4"



MULTIMPRONTA SPLINE DRIVE



BUSSOLE CHROM-VANADIUM MULTIMPRONTA "SPLINE DRIVE" - LUNGHE

Attacco: 1/4"

impronta: SPLINE DRIVE

BGS articolo	mm	L mm	Impronta	Euro
BGS 10154	4	50	1	3,06
BGS 10155	5	50	1	3,06
BGS 10156	6	50	1	3,06
BGS 10157	7	50	1	3,32
BGS 10158	8	50	1	3,32
BGS 10159	9	50	1	3,32
BGS 10160	10	50	1	3,57
BGS 10161	11	50	1	3,83
BGS 10162	12	50	1	3,83
BGS 10163	13	50	1	3,83



1/4"



PRO+



ESAGONO

BGS articolo	DESCRIZIONE	Euro
BGS 2221	SET 11 PEZZI, BUSSOLE ATT. 1/4", LUNGHEZZA 50 MM, 4-13 MM	21,68

CARATTERISTICHE

- esagonali
- finitura satinata cromata
- 4-5-5,5-6-7-8-9-10-11-12-13 mm
- su guida metallica



1/4"



POLIGONALE

BGS articolo	DESCRIZIONE	Euro
BGS 5251	SET 11 PEZZI, BUSSOLE TIPO LUNGO, POLIGONALI, ATT. 1/4"	22,19

CARATTERISTICHE

- misure: 4-5-5,5-6-7-8-9-10-11-12-13 mm
- finitura satinata cromata
- su supporto in plastica

POLLICI



1/4"



ESAGONO



BGS articolo	DESCRIZIONE	Euro
BGS 2429	SET 11 PEZZI, BUSSOLE ESAGONALI IN POLLICI LUNGHE	22,06

CARATTERISTICHE

- esagonali
- 3/16", 7/32", 1/4", 9/32", 5/16", 11/32", 3/8", 13/32", 7/16", 15/32", 1/2"
- finitura satinata cromata

POLLICI



1/4"



POLIGONALE



BGS articolo	DESCRIZIONE	Euro
BGS 2757	SET 12 PEZZI, BUSSOLE POLIGONALI IN POLLICI LUNGHE	24,23

CARATTERISTICHE

- poligonali
- misure: 5/32", 3/16", 7/32", 1/4", 9/32", 5/16", 11/32", 3/8", 7/16", 15/32", 1/2", 9/16"
- finitura cromata satinata



1/4"



TORX®

BGS articolo	DESCRIZIONE	Euro
BGS 6403	SET 6 PEZZI, BUSSOLE TORX ATT. 1/4", LUNGHE, E4 - E10	21,42

CARATTERISTICHE

- misure: E4 - E5 - E6 - E7 - E8 - E10
- lunghezza: 50 mm

TORX®	S mm	S mm	
E 4	3.70	E 16	14.60
E 5	4.60	E 18	16.50
E 6	5.60	E 20	18.30
E 7	6.10	E 22	20.10
E 8	7.40	E 24	22.00
E 10	9.30	E 26	23.70
E 11	9.90	E 28	25.50
E 12	11.00	E 30	27.30
E 14	12.80	E 32	29.00





1/4"



PHILLIPS®

attacco: 1/4"
impronta: PHILLIPS®

BGS	articolo	mm	L mm	mm	Euro
BGS 2504	PH 0	38	1	3,57	
BGS 2490	PH 1	38	1	3,57	
BGS 2488	PH 2	38	1	3,57	
BGS 2489	PH 3	38	1	3,57	



1/4"



POZIDRIV®

attacco: 1/4"
impronta: POZIDRIV®

BGS	articolo	mm	L mm	mm	Euro
BGS 2505	PZ 0	38	1	3,57	
BGS 2490	PZ 1	38	1	3,57	
BGS 2491	PZ 2	38	1	3,57	
BGS 2492	PZ 3	38	1	3,57	



1/4"



TAGLIO

attacco: 1/4"
impronta: TAGLIO

BGS	articolo	mm	L mm	mm	Euro
3724-0030	3	35	1	3,57	
BGS 2493	4	38	1	3,57	
3724-0045	4,5	35	1	3,57	
BGS 2494	5,5	38	1	3,57	
3724-0060	6	35	1	3,57	
BGS 2495	6,5	38	1	3,57	
BGS 2496	7	38	1	3,57	

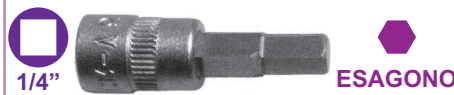

1/4"

ESAGONO

BRUGOLA TCCE

attacco: 1/4"
impronta: ESAGONO

BGS	articolo	mm	L mm	mm	Euro
BGS 5152	1,5	38	1	3,05	
BGS 5153	2	38	1	3,05	
BGS 5154	2,5	38	1	3,05	
BGS 2497	3	38	1	3,05	
BGS 2498	4	38	1	3,05	
BGS 2499	5	38	1	3,05	
3725-0055	5,5	35	1	3,05	
BGS 2500	6	38	1	3,05	
BGS 2501	7	38	1	3,05	
BGS 2502	8	38	1	3,05	
BGS 2161-10	10	38	1	3,05	
BGS 2161-12	12	38	1	3,05	

POLLICI

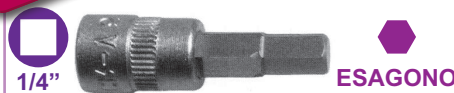

1/4"

ESAGONO

BRUGOLA TCCE - IN POLLICI

attacco: 1/4"
impronta: ESAGONO

BGS	articolo	pollici	L mm	mm	Euro
BGS 2740	3/32"	38	1	1,40	
BGS 2741	1/8"	38	1	1,79	
BGS 2742	5/32"	38	1	1,79	
BGS 2743	3/16"	38	1	1,79	
BGS 2744	7/32"	38	1	1,79	
BGS 2745	1/4"	38	1	1,79	
BGS 2746	9/32"	38	1	1,79	
BGS 2747	5/16"	38	1	1,79	
BGS 2748	3/8"	38	1	2,55	

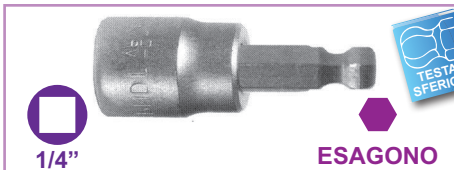

1/4"

ESAGONO

BRUGOLA TESTA SFERICA

attacco: 1/4"
impronta: ESAGONO

FERMEC	articolo	mm	L mm	mm	Euro
3732-0020	2	35	1	3,78	
3732-0025	2,5	35	1	3,78	
3732-0030	3	35	1	3,78	
3732-0040	4	35	1	3,78	
3732-0050	5	35	1	3,78	
3732-0060	6	35	1	3,78	
3732-0080	8	35	1	3,78	
BGS 9833	4	300	1	14,79	

NEW



1/4"



TORX®

attacco: 1/4"
impronta: TORX®

BGS	articolo	mm	L mm	mm	Euro
3733-0006	TX 6	35	1	3,05	
BGS 2557	TX 7	38	1	3,05	
BGS 2589	TX 8	38	1	3,05	
BGS 2588	TX 9	38	1	3,05	
BGS 2590	TX 10	38	1	3,05	
BGS 2591	TX 15	38	1	3,05	
BGS 2592	TX 20	38	1	3,05	
BGS 2593	TX 25	38	1	3,05	
BGS 2594	TX 27	38	1	3,05	
BGS 2595	TX 30	38	1	3,05	
BGS 2565	TX 35	38	1	3,05	
BGS 2596	TX 40	38	1	3,05	
BGS 2164-T45	TX 45	38	1	3,05	
BGS 2164-T50	TX 50	38	1	3,05	
BGS 2565-75	TX 35	75	1	3,19	
BGS 4202	TX 30	400	1	9,82	

TORX®	S mm	S mm	
T 6	1.70	T 40	6.70
T 7	2.00	T 45	7.90
T 8	2.30	T 50	8.90
T 9	2.50	T 55	11.30
T 10	2.70	T 60	13.30
T 15	3.30	T 70	15.60
T 20	3.90	T 80	17.60
T 25	4.50	T 90	20.00
T 27	5.00	T 100	22.20
T 30	5.60		



1/4"

TORX®
CON FORO

attacco: 1/4"
impronta: TORX® C/FORO

BGS	articolo	mm	L mm	mm	Euro
3734-0006	TH 6	35	1	3,99	
3734-0007	TH 7	35	1	3,99	
BGS 2356	TH 8	38	1	3,99	
BGS 2364	TH 9	38	1	3,99	
BGS 2357	TH 10	38	1	3,99	
BGS 2358	TH 15	38	1	3,99	
BGS 2359	TH 20	38	1	3,99	
BGS 2360	TH 25	38	1	3,99	
BGS 2361	TH 27	38	1	3,99	
BGS 2362	TH 30	38	1	3,99	
BGS 2363	TH 40	38	1	3,99	
BGS 2165-T45	TH 45	38	1	3,99	
BGS 2165-T50	TH 50	38	1	3,99	
BGS 4203	TH 30	100	1	5,50	



PENTALOBATA CON FORO

1/4"

BUSSOLA 5 PUNTE CON FORO
attacco: DIN 3121
impronta: 5 PUNTE C/FORO

BGS articolo	T	L mm		Euro
BGS 5184-TS10	T 10	38	1	3,68
BGS 5184-TS15	T 15	38	1	3,68
BGS 5184-TS20	T 20	38	1	3,68
BGS 5184-TS25	T 25	38	1	3,68
BGS 5184-TS27	T 27	38	1	3,68
BGS 5184-TS30	T 30	38	1	3,68
BGS 5184-TS40	T 40	38	1	3,68
BGS 5184-TS45	T 45	38	1	3,68
BGS 5184-TS50	T 50	38	1	3,68



PENTALOBATA CON FORO

1/4" **PRO+**

BGS articolo	DESCRIZIONE	Euro
BGS 2355	SET 9 PEZZI, CHIAVI A BUSSOLA 5 PUNTE C/FORO	22,82

CARATTERISTICHE

- TS-10-15-20-25-27-30-40-45-50
- per fissaggio di pompe nei dispositivi antifurto di MB Atego, Actros e Rover
- su guida porta bussola, imballaggio supplementare in custodia di plastica



ESAGONO

1/4" **PRO+** **CV**

BGS articolo	DESCRIZIONE	Euro
BGS 5151	SET 6 PEZZI, CHIAVI A BUSSOLA ESAGONO MASCHIO, ATTACCO 1/4"	8,93

CARATTERISTICHE

- misure: 1.5 - 2 - 2.5 - 3.5 - 4 - 6 mm
- attacco quadro 1/4"
- su guida metallica

PENTALOBATA	S mm	S mm
8 PR	2.20	27 PR 4.70
9 PR	2.40	30 PR 5.20
10 PR	2.60	40 PR 6.30
15 PR	3.10	45 PR 7.40
20 PR	3.60	50 PR 8.40
25 PR	4.10	55 PR 10.60



1/4" PHILLIPS POZIDRIV TAGLIO

PRO+ **CV**

BGS articolo	DESCRIZIONE	Euro
BGS 2163	SET 12 PEZZI, BUSSOLE PH, PZ E TAGLIO, ATT. 1/4"	18,50

CARATTERISTICHE

- comprende:
 - bussole taglio: 4 - 5,5 - 6,5 - 7 mm
 - bussole PH: 0 - 1 - 2 - 3
 - bussole PZ: 0 - 1 - 2 - 3
- finitura cromata satinata
- su guida metallica



XZN

1/4"

XZN

attacco: 1/4"
impronta: XZN

BGS articolo	M	L mm		Euro
BGS 5105-M4	M 4	38	1	2,04
BGS 5105-M5	M 5	38	1	2,04
BGS 5105-M6	M 6	38	1	2,04
BGS 2503	M 8	38	1	2,30
BGS 2506	M 10	38	1	3,06
BGS 2507	M 12	38	1	3,83

XZN	S mm	S mm
M 4	3,60	M12 11,50
M 5	4,80	M14 13,30
M 6	6,10	M16 15,70
M 8	7,30	M18 16,90
M10	9,70	



ESAGONO

1/4" **PRO+** **CV**

BGS articolo	DESCRIZIONE	Euro
BGS 2161	SET 7 PEZZI, BUSSOLE ESAGONALI, ATT. 1/4"	14,21

CARATTERISTICHE

- misure: 4 - 5 - 6 - 7 - 8 - 10 - 12 mm
- finitura cromata satinata
- su guida metallica



POLLICI

ESAGONO

1/4" **PRO+** **CV**

BGS articolo	DESCRIZIONE	Euro
BGS 2749	SET 9 PEZZI, CHIAVI A BUSSOLA ESAGONO MASCHIO IN POLLICI, ATTACCO 1/4"	14,66

CARATTERISTICHE

- misure: 3/32", 1/8", 5/32", 3/16", 7/32", 1/4", 9/32", 5/16", 3/8";
- attacco quadro 1/4"
- su guida metallica

1/4"

POLLICI

1/4"

ESAGONO

BGS articolo	DESCRIZIONE	Euro
BGS 2166	SET 7 PEZZI, BUSSOLE ESAGONALI, ATT. 1/4", IN POLLICI	13,77

CARATTERISTICHE

- misure: 1/8" - 5/32" - 3/16" - 7/32" - 1/4" - 5/16" - 3/8"
- lunghezza: 38 mm
- finitura cromata satinata
- su guida metallica



1/4" - 3/8" - 1/2"

ESAGONO

BGS articolo	DESCRIZIONE	Euro
BGS 5099	SET 10 PEZZI, CHIAVI A BUSSOLE ESAGONALI EXTRA CORTE, 4 - 19 MM	30,60

CARATTERISTICHE

- attacco 1/4", lunghezza 30 mm: 4 - 5 - 6 - 7 - 8 mm
- attacco 3/8", lunghezza 38 mm: 10 - 12 - 14 mm
- attacco 1/2", lunghezza 48 mm: 17 - 19 mm
- zigrinate
- finitura cromata satinata
- su guida metallica

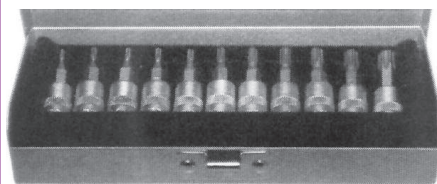

1/4"

TORX®

TORX®

CON FORO

- 11 BUSSOLE 1/4" CON INSERTI TORX®
- TX 6-7-8-9-10-15-20-25-27-30-40

attacco: 1/4"

impronta: TORX® - TORX® C/FORO

BGS articolo	Descrizione	Euro
3760	CASSETTA METALLICA 14 PEZZI	37,80
3761	CASSETTA METALLICA 11 PEZZI TORX® C/FORO	47,25



TESTA SFERICA



1/4"

TORX®

BGS articolo	DESCRIZIONE	Euro
BGS 8618	SET 7 PEZZI, BUSSOLE CON INSERTI TX CON TESTA SFERICA, ATT. 1/4"	36,98

CARATTERISTICHE

- ideale per lavorare in spazi ridotti
- misure: TX10-TX15-TX20-TX25-TX27-TX30-TX40
- lunghezza: 130 mm



TORX®

1/4"

BGS articolo	DESCRIZIONE	Euro
BGS 2164	SET CHIAVI A BUSSOLE CON TORX MASCHIO, ATT. 1/4", TX10 - TX50	13,01

CARATTERISTICHE

- misure: TX10-TX15-TX20-TX25-TX27-TX30-TX40-TX45-TX50
- finitura cromata satinata
- zigrinate
- su guida metallica



1/4"

3/8" - 1/2"

TORX®

BGS articolo	DESCRIZIONE	Euro
BGS 5098	SET 12 PEZZI, CHIAVI A BUSSOLE TORX® EXTRA CORTE, T8 - T60	28,05

CARATTERISTICHE

- attacco 1/4", lunghezza 30 mm: TX8 - TX10 - TX15 - TX20 - TX25 - Tx27
- attacco 3/8", lunghezza 38 mm: Tx30 - T4x0 - Tx45 - Tx50 - Tx55
- attacco 1/2", lunghezza 48 mm: Tx60
- zigrinate
- finitura cromata satinata
- su guida metallica



1/4"

TORX®

BGS articolo	DESCRIZIONE	Euro
BGS 9158	SET 8 PEZZI, CHIAVI A BUSSOLE SNODATE, TORX MASCHIO, TX8-TX40, ATT. 1/4"	62,92

CARATTERISTICHE

- misure: TX8 - TX10 - TX15 - TX20 - TX25 - TX27 - TX30 - TX40
- lunghezza: 42 mm
- finitura cromata lucida
- su guida metallica



1/4"

 TORX®

CON FORO

BGS articolo	DESCRIZIONE	Euro
BGS 2165	SET 9 PEZZI, CHIAVI A BUSSOLE TORX CON FORO MASCHIO, TH10-TH50, ATT. 1/4"	13,52

CARATTERISTICHE

- misure: TH10 - TH15 - TH20 - TH25 - TH30 - TH40 - TH45 - TH50
- finitura cromata satinata, zigrinate
- su guida metallica



BGS articolo	DESCRIZIONE	Euro
BGS 2162	SET 6 PEZZI, BUSSOLE XZN, ATT. 1/4"	12,24
CARATTERISTICHE		
<ul style="list-style-type: none"> • misure: M4 - M5 - M6 - M8 - M10 - M12 • finitura cromata satinata • su guida metallica 		



1/4"-3/8"-1/2"



BGS articolo	DESCRIZIONE	Euro
BGS 5105	SET 8 PEZZI, BUSSOLE XZN	21,17

CARATTERISTICHE		
<ul style="list-style-type: none"> • comprende: <ul style="list-style-type: none"> - attacco 1/4": M4-M5-M6 - attacco 3/8": M8-10-12 - attacco 1/2": M-14-16 • finitura cromata satinata • su guida metallica 		



NEW



QUADRO TAGLIO ESAGONO PHILLIPS®



BGS articolo	DESCRIZIONE	Euro
BGS 9523	SET 40 PEZZI, CHIAVI A BUSSOLA MASCHIO, PER USO A MACCHINA, ATT. 1/4"	121,13

CARATTERISTICHE		
<ul style="list-style-type: none"> • per uso manuale e con avvitatori a percussione • versione extra-corta • comprende: <ul style="list-style-type: none"> - 10 bussole Torx: TX10 - TX15 - TX20 - TX25 - TX27 - TX30 - TX40 - TX45 - TX47 - TX50 - 5 bussole Torx con Foro: TH30 - TH40 - TH45 - TH47 - TH50 - 5 bussole XZN: M4 - M5 - M6 - M8 - M10 - 4 bussole XZN con foro: MH5 - MH6 - MH8 - MH10 - 3 bussole Quadro/Robertson: 1 - 2 - 3 - 4 bussole Taglio: 3 mm - 4 mm - 5,5 mm - 7 mm - 7 bussole Esagonali: 3 - 4 - 5 - 6 - 7 - 8 - 10 mm - 4 bussole PH: 1 - 2 - 3 		



 TORX® TORX® CON FORO 1/4"-1/2"

FEEMEC articolo	DESCRIZIONE	Euro
2271	SET 72 PEZZI, UTENSILI TORX ATT. 1/4" + 1/2"	115,00

CARATTERISTICHE		
<ul style="list-style-type: none"> • bussole torx femmina: <ul style="list-style-type: none"> - att. 1/4": E4 - E5 - E6 - E7 - E8 - E10 - E11 - att. 1/2": E12 - E14 - E16 - E18 - E20 - E22 - E24 • chiavi a bussola Torx, att. 1/4": TX10 - TX15 - TX20 - TX25 - TX27 - TX30 • inserti att. 10 mm, lunghezza 30 mm, Torx c/ foro: TH40 - TH45 - TH50 - TH55 - TH60 - TH70 • inserti att. 10 mm, lunghezza 75 mm, Torx: TX15 - TX20 - TX25 - TX30 - TX40 - TX45 - TX50 - TX55 - TX60 • inserti att. 1/4", lunghezza 25 mm: <ul style="list-style-type: none"> - Torx: TX7 - TX8 - TX9 - Torx con foro: TH10 - TH15 - TH20 - TH25 - TH27 - TH30 - TH40 • Chiave Torx tipo L: TX8 - TX10 - TX15 - TX20 - TX25 - TX27 - TX30 - TX40 - TX45 - TX50 - TX55 - TX60 • cacciaviti Torx: TX8 - TX10 - TX15 - TX20 - TX25 - TX27 - TX30 - TX40 • chiavi doppio anello: E6 x E8 - E10 x E12 - E14 x E18 - E20 x E24 • adattatori <ul style="list-style-type: none"> - portainseri esag. fem. 1/4" - quadro fem. 1/4" - portainseri esag. fem. 10 mm - quadro fem. 1/2" • utensile di raccolta magnetico 		





1/4" 3/8" 1/2"

DESCRIZIONE	Euro
articolo SET 3 PEZZI, ADATTATORI DOPPIO QUADRO	
483814	12,60

CARATTERISTICHE

- comprende i seguenti adattatori con doppia sfera:
 - 1/4" M - 1/4" F, lunghezza 20 mm, art. 2841
 - 3/8" M - 3/8" F, lunghezza 30 mm, art. 3841
 - 1/2" M - 1/2" F, lunghezza 37 mm, art. 4841

ADATTATORI DOPPIO QUADRO MASCHIO

DESCRIZIONE	L mm	Euro
articolo SET 3 PEZZI, ADATTATORI DOPPIO QUADRO MASCHIO		
2841	20	4,00
3841	30	5,00
4841	37	6,00
BCS 9623 NEW	53	9,69

CARATTERISTICHE

- con doppia sfera



1/4"

1/4"

PROLUNGHE

attacco: 1/4"

DESCRIZIONE	L mm	Euro
articolo SET 3 PEZZI, PROLUNGHE TESTA SFERICA		
BCS 2336	50	3,15
3738-0075	75	3,36
BCS 2335	100	3,20
BCS 2338	150	5,04
BCS 9842	200	5,35
BCS 2210	300	6,76
BCS 2211	500	16,58



1/4"

1/4"

PROLUNGHE TESTA SFERICA

attacco: 1/4"

DESCRIZIONE	L mm	Euro
articolo SET 3 PEZZI, PROLUNGHE TESTA SFERICA		
BCS 2232	50	3,57
BCS 2231	100	3,83
BCS 2220	150	4,21
BCS 9844	200	5,36
BCS 2219	250	6,63



1/4"

1/4"

DESCRIZIONE	Euro
articolo SET 3 PEZZI, PROLUNGHE	
BCS 2233	14,03

CARATTERISTICHE

- lunghezze: 50-150-250 mm
- acciaio al cromo vanadio
- finitura cromata satinata
- zigrinate
- testa sferica

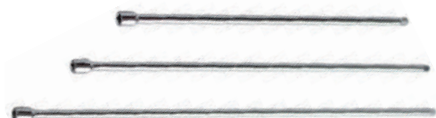

1/4"

1/4"

DESCRIZIONE	Euro
articolo SET 3 PEZZI, PROLUNGHE	
BCS 2235	15,30

CARATTERISTICHE

- attacco quadro 1/4"
- lunghezze: 300-380-450 mm
- finitura cromata lucida



1/4"

TESTA SFERICA

NEW

DESCRIZIONE	Euro
articolo SET 5 PEZZI, PROLUNGHE TESTA SFERICA, ATT. 1/4"	
BCS 6110	14,30

CARATTERISTICHE

- comprende le seguenti misure:
 - att. 1/4", lunghezza: 50, 75, 100, 150, 225 mm;
- finitura cromata lucida
- in supporto in plastica



1/4"-3/8"-1/2"

TESTA SFERICA

NEW

DESCRIZIONE	Euro
articolo SET 9 PEZZI, PROLUNGHE TESTA SFERICA	
BCS 6113	40,04

CARATTERISTICHE

- comprende le seguenti misure:
 - att. 1/4", lunghezza: 50, 100, 225 mm;
 - att. 3/8", lunghezza: 75, 150, 225 mm;
 - att. 1/2", lunghezza: 50, 125, 250 mm.
- finitura cromata lucida
- in supporto in plastica



FLEX



BGS articolo	DESCRIZIONE	Euro
BGS 2321	PROLUNGA FLESSIBILE	9,95

CARATTERISTICHE

- lunghezza: 450 mm



BGS articolo	DESCRIZIONE	Euro
BGS 198	SET 3 PEZZI PROLUNGHE MAGNETICHE	17,72

CARATTERISTICHE

- per trattenere viti e bulloni nella bussola

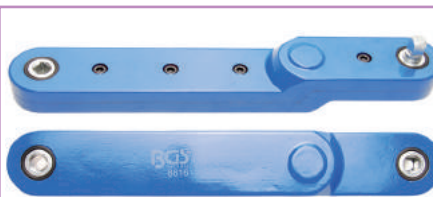

BGS articolo	DESCRIZIONE	Euro
BGS 8616	PROLUNGA SPECIALE ATT. 1/4", 265 MM	87,98

CARATTERISTICHE

- particolarmente indicate per viti in posizione di difficile accesso
- consente la trasmissione eccentrica
- utile, ad esempio per le viti sulle coperture anteriori di motori trasversali e altre applicazioni
- permette uno spostamento di 265 mm
- coppia massima: 55 Nm
- dimensioni: 33 x 300 mm



BGS articolo	L mm	Euro
BGS 250	35	5,40

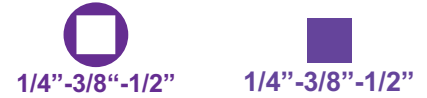

BGS articolo	DESCRIZIONE	Euro
BGS 252	SET 3 PEZZI, SNODI CON MOLLA	26,01

CARATTERISTICHE

- cromati



BGS articolo	L mm	Euro
BGS 3740	110	4,73



BGS articolo	L mm	Euro
BGS 3744-0150	150	7,88



BGS articolo	MASCHIO	FEMMINA	L mm	Euro
BGS 2232	1/4"	50	3,57	
BGS 2231	1/4"	100	3,83	
BGS 2219	1/4"	250	6,63	
BGS 242	3/8"	75	4,08	
BGS 243	3/8"	150	5,87	
BGS 244	3/8"	250	8,16	
BGS 233	1/2"	50	6,30	
BGS 234	1/2"	125	9,45	
BGS 235	1/2"	250	15,75	



BGS articolo	DESCRIZIONE	Euro
BGS 2320	PROLUNGA FLESSIBILE	4,72

CARATTERISTICHE

- lunghezza: 150 mm

1/4"



1/4"

PRO+



BGS articolo	DESCRIZIONE	Euro
BGS 216	IMPUGNATURA FINITURA CROMATA SATINATA	5,87

CARATTERISTICHE

- con impugnatura antiscivolo in materiale bi-componente
- lunghezza 150 mm



1/4"

IMPUGNATURE PORTA BUSSOLE

Kokon articolo	L mm	Euro
2769 N-150	150	12,62
2769 N-220	220	14,36



1/4"

IMPUGNATURE A TESTA SFERICA PORTA BUSSOLE

Kokon articolo	L mm	Euro
2769 NWF-150	150	13,48
2769 NWF-220	220	14,91

FLEX



1/4"

IMPUGNATURE PORTA BUSSOLE FLESSIBILE

FEARMEC articolo	L mm	Euro
3747	300	19,85

FLEX



1/4"

PRO+

BGS articolo	DESCRIZIONE	Euro
BGS 7825	IMPUGNATURA FLESSIBILE PORTA BUSSOLE	13,77

CARATTERISTICHE

- lunghezza 275 mm

FLEX



SET 3 PEZZI IMPUGNATURE FLESSIBILI

- 1 PORTA INSERTI 1/4"
- 1 PORTA BUSSOLE 1/4"
- 1 CON BUSSELA ESAGONALE DA MM 7

FEARMEC articolo	L mm	Euro
37416	600	47,25

FLEX



1/4"

PRO+

BGS articolo	DESCRIZIONE	Euro
BGS 7824	IMPUGNATURA FLESSIBILE, 500 MM	19,64

CARATTERISTICHE

- attacco 1/4"
- con 3 bussole da 4-5-7 mm

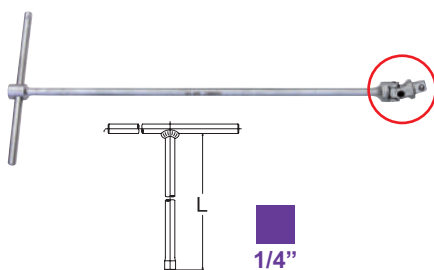

CHIAVE A "T" QUADRO MASCHIO SNODATA CROMATA ASTA SCORREVOLE CHROM-VANADIUM

FEARMEC articolo	L mm	Euro
581-1/4	500	18,38

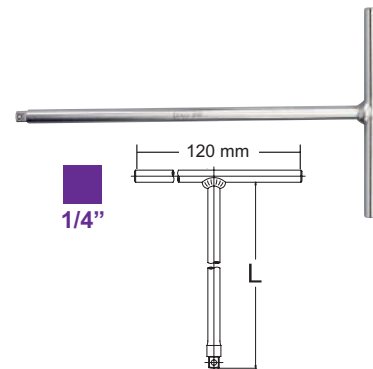

1/4"

CHIAVI A "T" MASCHIO QUADRO 1/4" LARGHEZZA IMPUGNATURA 120 MM

Kokon articolo	L mm	Euro
2715-1/4	200	20,02



1/4"

PRO+



BGS articolo	DESCRIZIONE	Euro
BGS 7800	IMPUGNATURA A T, CON QUADRO MASCHIO DA 1/4", LUNGHEZZA 230 MM	13,01

CARATTERISTICHE

- impugnatura ergonomica
- finitura satinata cromata
- lunghezza:
 - totale: 230
 - lama: 180



CRICCHETTO REVERSIBILE CON QUADRO FEMMINA PASSANTE

FEARMEC articolo	L mm	Euro
BGS 9160 NEW	115	23,14
3940	260	28,00
BGS 312	270	38,00
5840	450	60,00
BGS 9622 NEW	500	123,68
6040	250	30,00
6340	250	38,00
6540	250	38,00
6640	250	38,00

CARATTERISTICHE

- quadro passante
- impugnatura rivestita



NUOVO CRICCHETTO REVERSIBILE A 72 DENTI CON PULSANTE DI SBLOCCAGGIO DELLA BUSSOLA ED IMPUGNATURA ERGONOMICA BICOMPONENTE ANTISCIVOLO E FORMA OVALE

articolo	L mm	1	Euro
572	130	1	26,25
576787	SET 3 PEZZI 1/4" - 3/8" - 1/2"	1	94,50



MINI CRICCHETTO PORTA BUSSOLE 1/4" REVERSIBILE, CON PULSANTE DI SGANCIO RAPIDO

attacco: 1/4"

articolo	L mm	1	Euro
15133	90	1	12,60

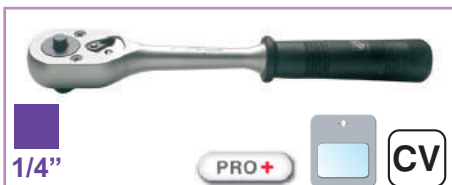

CHIAVE A CRICCHETTO REVERSIBILE 1/4"

DESCRIZIONE

articolo	Euro
BGS 2207	22,82

CARATTERISTICHE

- impugnatura in ABS
- con pulsante di sgancio rapido
- lunghezza: 155 mm

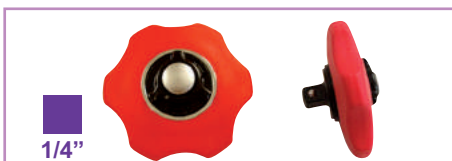

CRICCHETTO REVERSIBILE PORTA BUSSOLE 1/4" CON IMPUGNATURA A MANOPOLA PALMARE E PULSANTE DI SGANCIO

attacco: 1/4"

articolo	L mm	1	Euro
15116	25	1	13,65



1/4" **PRO+** **CV**

DESCRIZIONE	Euro
CRICCHETTO REVERSIBILE 1/4"	25,37

BGS 227

CARATTERISTICHE

- con pulsante di sgancio rapido
- impugnatura in gomma in materiale bi-componente
- lunghezza: 150 mm



1/4" **PRO+** **CV**

DESCRIZIONE	Euro
CRICCHETTO REVERSIBILE 1/4"	24,23

BGS 315

CARATTERISTICHE

- con pulsante di sgancio rapido
- impugnatura antiscivolo ergonomica in gomma in materiale bi-componente
- lunghezza: 145 mm



BGS 600-REPAIR

1/4" **CV** **PRO+**

DESCRIZIONE	Euro
CRICCHETTO REVERSIBILE, MODELLO CURVO, ATTACCO 1/4"	16,58

BGS 600

CARATTERISTICHE

- cricchetto reversibile 90 denti
- modello curvo
- con pulsante di sgancio rapido
- acciaio al Cromo Vanadio
- lunghezza: 155 mm
- peso: 280 grammi
- impugnatura in materiale bi-componente

RICAMBI

DESCRIZIONE	Euro
SET RIPARAZIONE CRICCHETTO	7,14

BGS 600-REPAIR



1/4" **CV** **MECCANISMO 72 DENTI**

DESCRIZIONE	Euro
CRICCHETTO REVERSIBILE, 72 DENTI, ATTACCO 1/4"	13,52

BGS 517

CARATTERISTICHE

- impugnatura in materiale bi-componente
- con sgancio rapido
- lunghezza: 160 mm



1/4"



1/4" **PRO+** **CV**

BGS articolo	DESCRIZIONE	Euro
BGS 318	CRICCHETTO REVERSIBILE 1/4"	24,99

CARATTERISTICHE

- con pulsante di sgancio rapido
- stelo sfasato
- impugnatura antiscivolo ergonomica in gomma in materiale bi-componente
- lunghezza: 145 mm



1/4" **PRO+** **CV**

BGS articolo	DESCRIZIONE	Euro
BGS 302	CHIAVE A CRICCHETTO IN NYLON E FIBRA DI VETRO 1/4"	21,68

CARATTERISTICHE

- comodo utilizzo grazie ai materiali ultra-leggeri, nessun affaticamento
- i test su questo attrezzo hanno ottenuto risultati per capacità massima decisamente superiori ai limiti DIN
- lunghezza: circa 145 mm
- in polipropilene rivestito in acciaio CR-V con impugnatura in materiale bi-componente
- lunghezza: 155 mm



1/4" **PRO+** **CV**

BGS articolo	DESCRIZIONE	Euro
BGS 212	CRICCHETTO "COMPATTO" 1/4"	23,97

CARATTERISTICHE

- extra-piccolo
- per spazi ristretti e angusti
- 72 denti
- lunghezza: 110 mm
- con pulsante di sgancio rapido



BGS 9161



1/4" **CV** **PRO+**

BGS articolo	DESCRIZIONE	Euro
BGS 9160	CRICCHETTO PASSANTE, ATT. QUADRO FEMMINA 1/4"	23,14

CARATTERISTICHE

- 30 denti
- cromato satinato
- impugnatura in materiale bi-componente
- lunghezza: 115 mm

RICAMBI

BGS articolo	DESCRIZIONE	Euro
BGS 9161	ADATTATORE DOPPIO QUADRO 1/4"	5,10



1/4" **CV** **PRO+**

BGS articolo	DESCRIZIONE	Euro
BGS 610	CRICCHETTO REVERSIBILE, "EXTRA SLIM", ATTACCO 1/4"	30,09

CARATTERISTICHE

- cricchetto reversibile 72 denti
- modello dritto "extra slim"
- con pulsante di sgancio rapido
- acciaio al Cromo Vanadio
- lunghezza: 135 mm
- peso: 100 grammi
- impugnatura in materiale bi-componente

QUANDO MANCA LO SPAZIO



1/4" **RUOTANDO L'IMPUGNATURA SI OTTIENE LA ROTAZIONE DEL QUADRO DX/SX**

CRICCHETTO DOPPIA FUNZIONE:

- AZIONE A "CRICCO TRADIZIONALE"
- IMPUGNATURA ROTATIVA
- QUADRO MASCHIO SCORREVOLE

FERMEC articolo	L mm	1	Euro
932	1/4"	180	38,50



BGS 355-REPAIR

MECCANISMO 60 DENTI

1/4" PRO+ CV

BGS articolo	DESCRIZIONE	Euro
BGS 355	CHIAVE A CRICCHETTO ADATTA PER ESSERE USATA CON UNA SOLA MANO 1/4"	34,43

CARATTERISTICHE

- interruttore destro e sinistro si trovano nell'impugnatura della chiave, cosicché è possibile cambiare direzione usando la stessa mano che tiene la chiave
- testa cricchetto extra-piatta
- 60 denti
- angolo di rotazione ridotto
- finitura ad alta resistenza
- lunghezza: 150 mm

RICAMBI

BGS articolo	DESCRIZIONE	Euro
NEW BGS 355-REPAIR	KIT DI RIPARAZIONE	17,85



ESTENSIBILE

1/4" PRO+

BGS articolo	DESCRIZIONE	Euro
BGS 25103	CRICCHETTO REVERSIBILE ESTENSIBILE, 150-200 MM, ATTACCO 1/4"	34,43

CARATTERISTICHE

- regolabile in 3 posizioni da 150 a 200 mm
- acciaio al cromo vanadio, satinato
- cricchetto 72 denti
- con pulsante di sgancio rapido



MECCANISMO 72 DENTI

1/4" PRO+ CV

BGS articolo	DESCRIZIONE	Euro
BGS 25105	CRICCHETTO REVERSIBILE ESTENSIBILE SNODATO, 175-225 MM, ATTACCO 1/4"	39,53

CARATTERISTICHE

- regolabile in 3 posizioni da 175 a 225 mm
- testa snodata regolabile in 10 posizioni
- cricchetto 72 denti
- con pulsante di sgancio rapido
- acciaio al cromo vanadio, satinato



TESTA SNODATA

MECCANISMO 72 DENTI

1/4" PRO+

BGS articolo	DESCRIZIONE	Euro
BGS 112	CHIAVE A CRICCHETTO CON TESTA SNODATA, REGOLABILE, 1/4"	40,67

CARATTERISTICHE

- testa snodata 180°
- finitura cromata
- cricchetto reversibile 72 denti
- con pulsante di sgancio rapido
- lunghezza 160 mm



1/4" CV

BGS articolo	DESCRIZIONE	Euro
BGS 221	CRICCHETTO "KRAFTMANN" 1/4"	8,32

CARATTERISTICHE

- reversibile
- con impugnatura ergonomica in gomma
- lunghezza: 140 mm



MECCANISMO 72 DENTI

1/4"

CRICCHETTO REVERSIBILE 72 DENTI SNODATO CON PULSANTE DI BLOCCAGGIO BUSSOLA (RICAMBIO CASSETTA ART. 21492)

attacco: 1/4"

FERMEC articolo	L mm	1	Euro
3748	135	1	30,98



1/4" PRO+ CV

BGS articolo	DESCRIZIONE	Euro
BGS 285	CHIAVE A CRICCHETTO CON TESTA SNODATA, REGOLABILE 1/4"	39,88

CARATTERISTICHE

- finitura satinata cromata
- regolabili in sicurezza in 5 posizioni
- 45 denti
- con pulsante di sgancio rapido
- impugnatura con occhiello
- lunghezza 160 mm

SET 1/4"



1/4"

BGS articolo **DESCRIZIONE** Euro

BGS 2126 **CRICCHETTO SNODATO CON IMPUGNATURA A "T"** **60,44**

CARATTERISTICHE

- finitura cromata
- lunghezza 450 mm



1/4"

BGS articolo **DESCRIZIONE** Euro

BGS 2274 **CHIAVE A CRICCHETTO A FRIZIONE (SENZA DENTI) 1/4"** **44,63**

CARATTERISTICHE

- con quadro maschio scorrevole
- elimina l'angolo di ripresa dei cricchetti tradizionali
- ideale per l'utilizzo in spazi ridotti
- lunghezza: 125 mm



1/4"-3/8"-1/2"

BGS articolo **DESCRIZIONE** Euro

BGS 215 **SET 3 PEZZI, CRICCHETTI REVERSIBILI COMPATTI** **95,63**

CARATTERISTICHE

- formato extra-small per spazi ridotti e angusti
- 72 denti
- lunghezza cricchetti:
 - attacco 1/4": 110 mm
 - attacco 3/8": 170 mm
 - attacco 1/2": 140 mm



1/4"

BGS articolo **DESCRIZIONE** Euro

BGS 15105 **SET 27 PEZZI, BUSSOLE E CRICCHETTO, ATT. 1/4"** **31,07**

CARATTERISTICHE

- chiave a cricchetto reversibile da 1/4"
- 12 bussole Esagonali, attacco da 1/4": 4 - 4,5 - 5 - 5,5 - 6 - 7 - 8 - 9 - 10 - 11 - 12 - 13 mm
- 14 chiavi a bussola, attacco da 1/4":
 - TX 10 - 15 - 20 - 25 - 30
 - PH 1 - 2
 - Taglio 4 - 5,5 - 7 mm
 - Esagono 3 - 4 - 5 - 6 mm



1/4"

BGS articolo **DESCRIZIONE** Euro

BGS 21492 **VALIGETTA IN ALLUMINIO 40 PEZZI** **71,40**

CASSETTA 40 CHIAVI A BUSSOLA ESAGONALI CORTE E LUNGHE ED INSERTI 1/4" - CRICCHETTO 1/4" CON SNODO DA 4 A 14 MM

attacco: 1/4"



1/4"

BGS articolo **DESCRIZIONE** Euro

21717 **CASSETTA PLASTICA 17 PEZZI** **30,98**

15116 **RICAMBIO CRICCHETTO A MANOPOLA** **13,65**

CASSETTA 13 BUSSOLE ESAGONALI ATT. 1/4"

- 4-4,5-5-5,5-6-7-8-9-10-11-12-13-14 MM
- 3 PROLUNGHE 1/4" LUNGH. 50-100-150 MM
- 1 CRICCHETTO A MANOPOLA CON PULSANTE DI BLOCCAGGIO

attacco: 1/4"
impronta: ESAGONALE



POLLICI **NEW**

1/4" **1/2"** **ESAGONO** **PRO+** **CV**

BGS articolo **DESCRIZIONE** Euro

BGS 2246 **SET 23 PEZZI, BUSSOLE ESAGONALI IN POLLICI** **62,48**

CARATTERISTICHE

- bussole esagonali attacco 1/4": 5/32", 3/16", 7/32", 1/4", 9/32", 5/16", 11/32", 3/8", 7/16", 15/32"
- bussole esagonali attacco 1/2": 1/2", 9/16", 19/32", 5/8", 11/16", 3/4", 13/16", 7/8", 15/16", 1", 1-1/16", 1-1/8", 1-1/4"
- finitura satinata cromata
- zigrinate



NEW



BUSSOLE ESAGONALI

CV S2

CV

1/4" 3/8"



PRO+

BGS articolo	DESCRIZIONE	Euro
BGS 2289	SET 92 PEZZI. BUSSOLE E ACCESSORI ATTACCO 1/4" E 3/8"	224,88

CARATTERISTICHE

- comprende i seguenti utensili attacco 1/4": - cricchetto reversibile 72 denti - bussole esagonali: 4 - 4,5 - 5 - 6 - 7 - 8 - 9 - 10 - 11 - 13 mm - bussole esagonali lunghe: 6 - 8 - 10 - 11 - 13 mm - 1 adattatore portainseriti - 1 impugnatura 150 mm - 1 snodo - 1 prolunga - 1 leva con quadro scorrevole
- comprende i seguenti utensili attacco 3/8": - cricchetto reversibile 72 denti - bussole esagonali: 14 - 15 - 16 - 17 - 19 - 20 - 21 - 22 - 23 - 24 mm - bussole esagonali lunghe: 14 - 16 - 17 - 19 mm - 1 adattatore portainseriti - 1 snodo - 1 prolunga - 3 bussole per candele: 16 - 18 - 21 mm - 1 riduzione quadro 3/8" Femmina - quadro 1/4" Maschio
- 29 inserti (S2): - Taglio: 2 - 2,5 - 3 - 4 - 5 - 6 - 7 mm - PH: PH0, PH1, PH2, PH3 - PZ: PZ0, PZ1, PZ2, PZ3 - Esagonali: 1,5 - 2 - 2,5 - 3 - 4 - 5 - 7 mm - Torx: TX10 - TX15 - TX20 - TX25 - TX27 - TX30 - TX40
- 9 chiavi combinate: 6 - 8 - 10 - 11 - 13 - 14 - 16 - 17 - 19 mm
- 9 chiavi a L esagonali: 1,5 - 2 - 2,5 - 3 - 4 - 5 - 6 - 8 - 10 mm



1/4"



CASSETTA 46 CHIAVI A BUSSOLA ESAGONALI 1/4"

attacco: 1/4"

FEARMEC articolo	Descrizione	1	Euro
21460	CASSETTA PLASTICA 46 PZ	1	51,45

CARATTERISTICHE

- bussole: 4, 4,5, 5, 5,5, 6, 7, 8, 9, 10, 11, 12, 13, 14 mm
- inserti 1/4": Taglio 4,5, 5, 7 PH 1, 2, 3 PZ 1, 2, 3 ES 3, 4, 5, 6, 7, 8 TX 10, 15, 20, 25, 30, 40
- chiave a cricco 1/4" con pulsante di sgancio

POLLICI



1/4"



CASSETTA 46 CHIAVI A BUSSOLA ESAGONALI 1/4" - IN POLLICI

attacco: 1/4"

FEARMEC articolo	Descrizione	1	Euro
21532	CASSETTA PLASTICA 46 PZ.	1	57,75

CARATTERISTICHE

- bussole: 5/32", 3/16", 7/32", 1/4", 9/32", 5/16", 11/32", 3/8", 13/32", 7/16", 15/32", 1/2", 9/16"
- chiave a cricco 1/4" con pulsante di sgancio + inserti



1/4"



BGS articolo	DESCRIZIONE	Euro
BGS 2142	SET BUSSOLE DA 46 PEZZI, 1/4"	49,40

CARATTERISTICHE

- bussole surface drive da 4 a 13 mm
- completo di chiavi a bussola taglio, PH, esagonali e Torx in diversi formati
- realizzate in conformità con le norme DIN
- cricchetto reversibile 72 denti con impugnatura in materiale bi-componente
- in cromo vanadio

SET 1/4"





1/4"



PRO+

BGS articolo	DESCRIZIONE	Euro
BGS 2147	SET 52 PEZZI, BUSSOLE	93,08

CARATTERISTICHE

- durezza e coppia in conformità con DIN
- bussole con finitura Esagonale
- 1 chiave a cricchetto reversibile da 1/4" con pulsante di sgancio rapido
- 1 barra scorrevole a T
- 1 snodo
- 1 impugnatura attacco quadro
- 2 barre di prolunga 50 + 100 mm
- 3 chiavi tipo L 1,5 - 3 mm
- 18 chiavi a bussola attacco da 1/4": Taglio, Phillips, PZ, Esagono, Torx c/foro
- 13 bussole attacco da 1/4": 4-14 mm
- 6 bussole lunghe attacco da 1/4": 8-14 mm
- 7 bussole Torx attacco da 1/4": E4-E11

RICAMBI

BGS articolo	DESCRIZIONE	Euro
BGS 2147-LEER	CASSETTA VUOTA	12,37



1/4"



PRO+

BGS articolo	DESCRIZIONE	Euro
BGS 2144	SET 46 PEZZI, BUSSOLE	73,70

CARATTERISTICHE

- bussole e barre di prolunga con zigrinatura a spirale
- barre di prolunga con esagono
- 1 chiave a cricchetto reversibile da 1/4" con pulsante di sgancio rapido
- 1 snodo
- 3 chiavi tipo L
- 1 adattatore inserto
- 1 impugnatura quadro
- 3 barre di prolunga da 1/4"
- 12 bussole attacco da 1/4" 4-13 mm
- 24 inserti da 1/4": Phillips, Taglio, PZ, Torx c/foro, Esagono
- Imballaggio in doppio blister

RICAMBI

BGS articolo	DESCRIZIONE	Euro
BGS 2144-1	CASSETTA VUOTA	10,07



1/4"



PRO+

BGS articolo	DESCRIZIONE	Euro
BGS 2146	SET 46 PEZZI, BUSSOLE	84,02

CARATTERISTICHE

- **chiavi a bussola Torx c/foro**
- contenuto:
 - 1 adattatore 1/4" esagonale x 1/4" quadrato
 - 1 impugnatura attacco quadro
 - 2 barre di prolunga 50 + 100 mm
 - 1 snodo
 - 1 barra scorrevole a T
 - 1 barra di prolunga flessibile
 - 1 chiave a cricchetto reversibile con pulsante di sgancio rapido
 - 3 chiavi tipo L Esagono: 1,5 - 2 - 3 mm
 - 6 chiavi a bussola Torx c/ foro attacco 1/4": Th10-Th15-Th20-Th25- Th30-Th40
 - 11 chiavi a bussola attacco da 1/4": Taglio, PH, PZ, Esagono
 - 13 bussole "surface drive" attacco 1/4": 4-4.5-5-5.5-6-7-8-9-10-11-12-13-14 mm mm

RICAMBI

BGS articolo	DESCRIZIONE	Euro
BGS 2146-LEER	CASSETTA VUOTA	12,50





BUSSOLE MULTIMPRONTA SPLINE DRIVE

1/4"



SET INSERTI E BUSSOLE MULTIMPRONTA DA 5 A 13 MM CON MINI CRICCHETTO REVERSIBILE E PROLUNGA L. 50 MM

attacco: 1/4"
impronta: Spline drive

FEARMEC articolo	Descrizione	Euro
BIT-33	BOX PLASTICA	1 32,55



BUSSOLE MULTIMPRONTA SPLINE DRIVE

1/4"



MULTIMPRONTA SPLINE DRIVE

CASSETTA BUSSOLE MULTIMPRONTA ATTACCO 1/4" ADATTE PER DADI ESAGONALI POLIGONALI - POLLICI - QUADRI - XZN® - TORX® - PEZZI 30 DA 4-14 MM

FEARMEC articolo	Descrizione	Euro
FRM 4205	VALIGETTA 30 PEZZI	1 59,70



BUSSOLE MULTIMPRONTA SPLINE DRIVE



1/4"

CV

PRO+

BG articolo	DESCRIZIONE	Euro
BGS 2143	SET 28 PEZZI, BUSSOLE MULTIMPRONTA	52,28

CARATTERISTICHE

- 1 chiave a cricchetto a 72 denti (extra-corto - lunghezza 108 mm)
- 1 barra di prolunga da 1/4" 50 mm
- 1 portainseri
- 9 bussole "multimpronta": 5-6-7-8-9-10-11-12-13 mm
- La testa Multimpronta si adatta a dadi esagonali, a 12 punti, metrici + in pollici, Torx
- 16 inserti da 1/4" acciaio S2: PH no. 1+2; PZ no. 1+2; Taglio 4,5+6 mm Esagono 3+4+5 mm Torx TX10-15-20-25-27-30-40

RICAMBI

BG articolo	DESCRIZIONE	Euro
BGS 2143-LEER	CASSETTA VUOTA	4,08

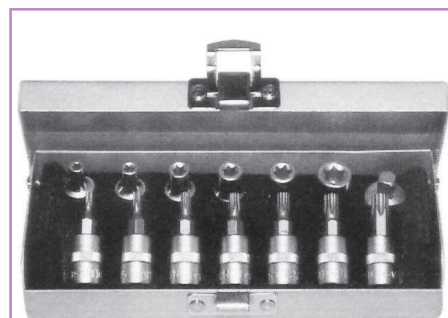

1/4"

TORX®

- 6 BUSSOLE TORX® 1/4" - E 4-5-6-7-8-10
- 7 BUSSOLE CON INSERTI TORX® TX 10-15-20-25-27-30-40
- 1 ADATTATORE F. 3/8" - M. 1/4"

attacco: 1/4"
impronta: TORX®

FEARMEC articolo	Descrizione	Euro
3765	CASSETTA METALLICA 14 PEZZI	1 47,25



1/4"-3/8"

ESAGONO 5/16" C

TORX®

TORX® CON FORO

PRO+

CV

BG articolo	DESCRIZIONE	Euro
BGS 5023	SET 17 PEZZI, BUSSOLE E INSERTI TORX	29,23

CARATTERISTICHE

- bussole
- attacco 1/4": E 6-7-8
- attacco 3/8": E 10-12-14-16
- 9 inserti Torx c/foro attacco esagonale 5/16": TH 10-15-20-25-30-40-45-50-55
- adattatore portainseri attacco quadro 3/8" x 5/16" esagonale

RICAMBI

BG articolo	DESCRIZIONE	Euro
BGS 5023-LEER	CASSETTA VUOTA	7,14



1/4"-3/8"-1/2"

TORX®

- 5 BUSSOLE TORX® FEMMINA ATT. 1/4" E 4-5-6-7-8
- 5 BUSSOLE TORX® FEMMINA ATT. 3/8" E 10-11-12-14-16
- 4 BUSSOLE TORX® FEMMINA ATT. 1/2" E 18-20-22-24

Attacco: 1/4" - 3/8" - 1/2"
impronta: TORX®

FEARMEC articolo	Descrizione	Euro
54214	CASSETTA PLASTICA 14 PEZZI	1 44,10

SET 1/4"



1/4"-3/8"-1/2"-3/4" 1/4"-3/8"-1/2"-3/4"

RACCORDI DI RIDUZIONE CHROM-VANADIUM

attacco: 1/4" - 3/8" - 1/2" - 3/4"

BCS articolo	FEMMINA	MASCHIO		Euro
BGS 271	1/4"	3/8"	1	3,15
BGS 269	3/8"	1/4"	1	3,15
BGS 280	3/8"	1/2"	1	3,68
BGS 270	1/2"	3/8"	1	3,68
BGS 272	1/2"	3/4"	1	8,40
BGS 274	3/4"	1/2"	1	8,40

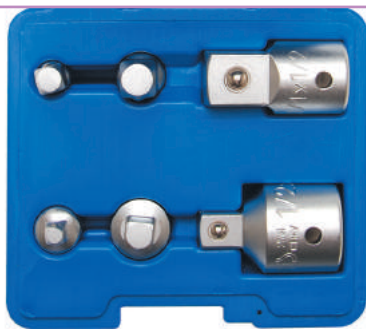

PRO+

CV

BCS articolo	DESCRIZIONE	Euro
BGS 199	SET 6 PEZZI ADATTATORI	24,23

CARATTERISTICHE

- cromati satinati

CONTENUTO

- 1/4" F X 3/8" M, coppia massima 60 Nm
- 3/8" F X 1/4" M, coppia massima 60 Nm
- 3/8" F X 1/2" M, coppia massima 200 Nm
- 1/2" F X 3/8" M, coppia massima 200 Nm
- 1/2" F X 3/4" M, coppia massima 500 Nm
- 3/4" F X 1/2" M, coppia massima 500 Nm

RICAMBI

BCS articolo	DESCRIZIONE	Euro
BGS 199-LEER	CASSETTA VUOTA	5,36

4x

Steckschlüssel-Adapter-Satz

6,3	1/4"	10	3/8"
10	3/8"	6,3	1/4"
10	3/8"	12,5	1/2"
12,5	1/2"	10	3/8"

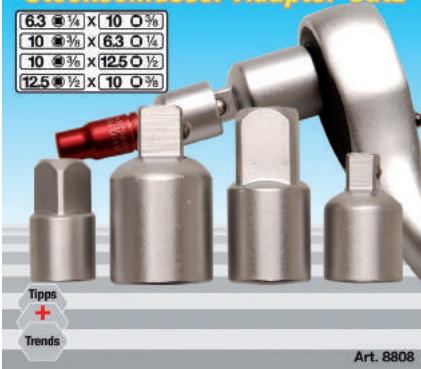

Tipps + Trends

Art. 8808



1/4"-3/8"-1/2"



CV

BCS articolo	DESCRIZIONE	Euro
BGS 8808	SET 4 PEZZI, RIDUZIONI	10,25

CARATTERISTICHE

- comprende 4 riduzioni:
 - 1/4" F - 3/8" M
 - 3/8" F - 1/4" M
 - 3/8" F - 1/2" M
 - 1/2" F - 3/8" M
- finitura cromata satinata

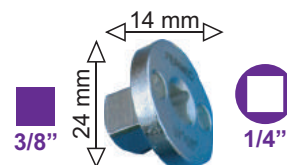

3/8"

1/4"

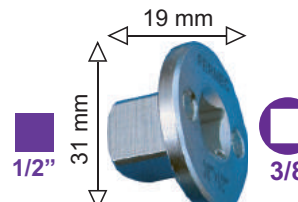

1/2"

3/8"

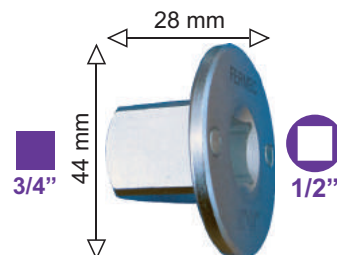

3/4"

1/2"

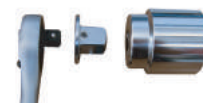

RACCORDI DI RIDUZIONE MAGNETICI A SCOMPARSA IDEALI PER CHIAVI DINAMOMETRICHE E SPAZI RIDOTTI

attacco: 1/4"-3/8"-1/2"

FERMEC articolo	FEMMINA	MASCHIO		Euro
1434-1/4	1/4"	3/8"	1	8,93
1434-3/8	3/8"	1/2"	1	9,98
1434-1/2	1/2"	3/4"	1	11,03
1434	SET DA 3 PEZZI IN BLISTER		1	28,35



ESAGONO

CHIAVI A BUSSOLA A MACCHINA BOCCA ESAGONALE

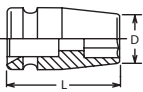

Koken articolo	mm	D mm	L mm	Euro
12400M-4	4	7.5	23	5,78
12400M-4.5	4.5	8.1	23	5,78
12400M-5	5	8.8	23	5,78
12400M-5.5	5.5	9.4	23	5,78
12400M-6	6	10	23	5,78
12400M-7	7	11.3	23	5,78
12400M-8	8	12.5	23	5,78
12400M-9	9	13.8	23	5,78
12400M-10	10	15	23	5,94
12400M-11	11	16.3	23	6,13
12400M-12	12	17.5	23	6,13
12400M-13	13	18.8	23	6,66
12400M-14	14	20	23	7,01

ESAGONO

CHIAVI A BUSSOLA A MACCHINA BOCCA ESAGONALE CON MAGNETE

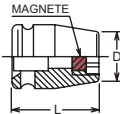

Koken articolo	mm	D mm	L mm	Euro
12400MG-4	4	7.5	23	11,03
12400MG-4.5	4.5	8.1	23	11,03
12400MG-5	5	8.8	23	11,03
12400MG-5.5	5.5	9.4	23	11,03
12400MG-6	6	10	23	11,03
12400MG-7	7	11.3	23	11,25
12400MG-8	8	12.5	23	11,39
12400MG-9	9	13.8	23	11,39
12400MG-10	10	15	23	11,80
12400MG-11	11	16.3	23	11,85
12400MG-12	12	17.5	23	11,85
12400MG-13	13	18.8	23	11,85
12400MG-14	14	20	23	18,98

FAST LEAD

CHIAVI A BUSSOLA A MACCHINA BOCCA FAST LEAD



Koken articolo	mm	D mm	L mm	Euro
12465M-10	10	15	23	12,49
12465M-11	11	16.3	23	12,49
12465M-12	12	17.5	23	12,49
12465M-13	13	18.8	23	12,49

POLLICI

ESAGONO

CHIAVI A BUSSOLA A MACCHINA BOCCA ESAGONALE

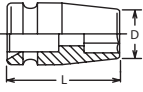

Koken articolo	pollici	D mm	L mm	Euro
12400A-5/32	5/32"	7.5	23	6,22
12400A-3/16	3/16"	8.1	23	6,22
12400A-7/32	7/32"	9.4	23	6,22
12400A-1/4	1/4"	10	23	6,22
12400A-9/32	9/32"	11.3	23	6,22
12400A-5/16	5/16"	12.5	23	6,22
12400A-11/32	11/32"	13.8	23	6,22
12400A-3/8	3/8"	15	23	6,38
12400A-7/16	7/16"	16.3	23	6,57
12400A-1/2	1/2"	18.8	23	7,18
12400A-9/16	9/16"	20	23	7,54

POLLICI

ESAGONO

CHIAVI A BUSSOLA A MACCHINA BOCCA ESAGONALE CON MAGNETE

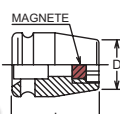

Koken articolo	pollici	D mm	L mm	Euro
12400AG-3/16	3/16"	8.1	23	11,85
12400AG-1/4	1/4"	10	23	11,85
12400AG-5/16	5/16"	12.5	23	12,29
12400AG-11/32	11/32"	13.8	23	12,29
12400AG-3/8	3/8"	15	23	12,71
12400AG-7/16	7/16"	16.3	23	12,76
12400AG-1/2	1/2"	18.8	23	12,76
12400AG-9/16	9/16"	20	23	20,43

FAST LEAD

CHIAVI A BUSSOLA A MACCHINA BOCCA FAST LEAD TIPO LUNGO



Koken articolo	mm	D mm	L mm	Euro
12365M-10	10	15	48	15,26
12365M-11	11	16.3	48	15,26
12365M-12	12	17.5	48	15,26
12365M-13	13	18.8	48	15,26

TORX®

CHIAVI A BUSSOLA A MACCHINA BOCCA TORX®

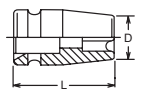

Koken articolo		D mm	L mm	Euro
12425-E 4	E 4	6.6	23	8,25
12425-E 5	E 5	7.7	23	8,25
12425-E 6	E 6	8.7	23	8,25
12425-E 7	E 7	9.2	23	8,25
12425-E 8	E 8	9.7	23	8,25
12425-E10	E 10	12.2	23	8,25

ESAGONO

CHIAVI A BUSSOLA A MACCHINA BOCCA ESAGONALE TIPO LUNGO



Koken articolo	mm	D mm	L mm	Euro
12300M-6	6	10	48	13,59
12300M-7	7	11.3	48	13,59
12300M-8	8	12.5	48	13,59
12300M-10	10	15	48	13,59
12300M-12	12	17.5	48	13,75
12300M-13	13	18.8	48	13,75
12300M-14	14	20	48	14,99

SURFACE DRIVE

CHIAVI A BUSSOLA A MACCHINA BOCCA SURFACE DRIVE

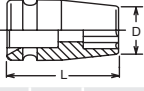

Koken articolo	mm	D mm	L mm	Euro
12410M-6	M 6	10	23	6,08
12410M-7	M 7	11.3	23	6,08
12410M-8	M 8	12.5	23	6,08
12410M-9	M 9	13.8	23	6,08
12410M-10	M 10	15	23	6,22
12410M-11	M 11	16.3	23	6,41
12410M-12	M 12	17.5	23	6,41
12410M-13	M 13	18.8	23	7,01

ESAGONO

CHIAVI A BUSSOLA POWER BOCCA ESAGONALE



PARETI SOTTILI SU TUTTO IL CORPO

Koken articolo	mm	D mm	L mm	Euro
22400M-6	6	9	22	3,77
22400M-7	7	10.2	22	3,77
22400M-8	8	11.3	22	3,77
22400M-10	10	14.3	22	3,88
22400M-12	12	17.4	22	4,18
22400M-13	13	18	22	4,54

IMPACT 1/4"

1/4" IMPACT

PARETI SOTTILI SU TUTTO IL CORPO

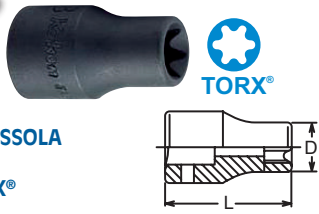

CHIAVI A BUSSOLA POWER BOCCA TORX®

Koken articolo		D mm	L mm		Euro
22425-E 4	E 4	5.4	23	1	5,39
22425-E 5	E 5	6.7	23	1	5,39
22425-E 6	E 6	7.7	23	1	5,39
22425-E 7	E 7	8.3	23	1	5,39
22425-E 8	E 8	9.6	23	1	5,39
22425-E10	E 10	11.3	23	1	5,39

TORX®	S mm	S mm	
E 4	3.70	E 16	14.60
E 5	4.60	E 18	16.50
E 6	5.60	E 20	18.30
E 7	6.10	E 22	20.10
E 8	7.40	E 24	22.00
E 10	9.30	E 26	23.70
E 11	9.90	E 28	25.50
E 12	11.00	E 30	27.30
E 14	12.80	E 32	29.00

PARETI SOTTILI SU TUTTO IL CORPO



CHIAVI A BUSSOLA POWER BOCCA ESAGONALE LUNGHE

Koken articolo	mm	D mm	L mm		Euro
22300M-7	7	10.9	50	1	10,51
22300M-8	8	11.6	50	1	10,51
22300M-10	10	14.3	50	1	10,51
22300M-12	12	17.4	50	1	10,51
22300M-13	13	18	50	1	11,36

POLLICI

PARETI SOTTILI SU TUTTO IL CORPO

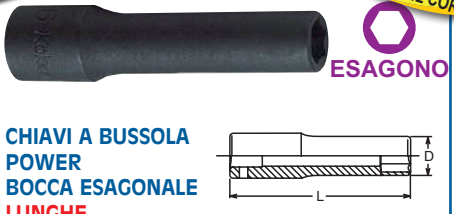

CHIAVI A BUSSOLA POWER BOCCA ESAGONALE LUNGHE

Koken articolo	pollici	D mm	L mm		Euro
22300A-1/4	1/4"	9.8	50	1	11,33
22300A-5/16	5/16"	11.6	50	1	11,33
22300A-3/8	3/8"	14.3	50	1	11,33



CHIAVI A BUSSOLA A MACCHINA BOCCA ESAGONALE CON MAGNETE RETRATTILE

Koken articolo	mm	D mm	L mm			Euro
195-7 L FM	7		45	1		25,55
12300G-8	8	12.5	48	1		25,55
12300G-10	10	15	48	1		25,55
12300G-12	12	17.5	48	1		25,55
12300G-13	13	18.8	48	1		29,15
12300G-14	14	20	48	1		30,36



BUSSOLE ESAGONALI MASCHIO INTEGRALI

FERMEC articolo	mm	L mm		Euro
182-1/4-3	3	25	1	9,98
182-1/4-4	4	25	1	9,98
182-1/4-5	5	25	1	9,98
182-1/4-6	6	25	1	9,98
182-1/4-8	8	25	1	9,98
182-1/4-10	10	25	1	9,98

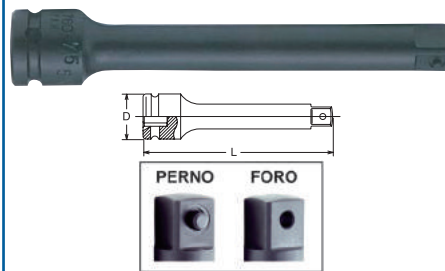

PROLUNGA

Koken articolo	D mm		L mm		Euro
12760-55P	13	PERNO	55	1	16,78
12760-75P	13	PERNO	75	1	16,94
NEW 12760-100P	13	PERNO	100	1	19,33
NEW 12760-150P	13	PERNO	150	1	26,76
NEW 12760-200P	13	PERNO	200	1	28,05
NEW 12760-55	13	FORO	55	1	16,78
NEW 12760-75	13	FORO	75	1	16,78
NEW 12760-100	13	FORO	100	1	19,33
NEW 12760-150	13	FORO	150	1	26,76

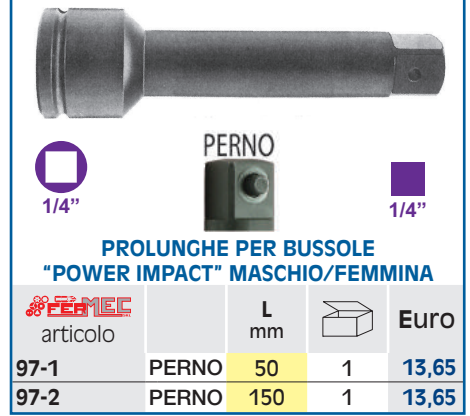

FERMEC articolo		L mm		Euro
97-1	PERNO	50	1	13,65
97-2	PERNO	150	1	13,65



BGS articolo	DESCRIZIONE	Euro
BGS 188	SNODO A MACCHINA	15,00

CARATTERISTICHE
• finitura nera
• con sfera di tenuta

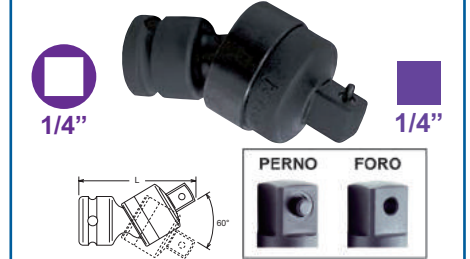

Koken articolo		L mm		Euro
12770-P	PERNO	39	1	37,92
NEW 12770	FORO	39	1	37,92



IMPACT 1/4"

NEW

BGS
articolo
BGS 9459

DESCRIZIONE
SET 3 PEZZI, SNODI

Euro
38,00

CARATTERISTICHE

- con scanalatura e foro per spina
- comprende:
 - snodo 1/4" F - 1/4" M
 - snodo 3/8" F - 3/8" M
 - snodo 1/2" F - 1/2" M

MANDRINO CON SGANCIO RAPIDO PER BUSSOLE "POWER IMPACT"

attacco: Quadro femmina

articolo	F	M	L mm	Euro
195-SWF	1/4"	1/4"	41	42,00
196-SWF	3/8"	3/8"	46	42,00
197-SWF	1/2"	1/2"	60	46,20
199-SWF	3/4"	3/4"	78	114,35
1991-SWF	1"	1"	100	131,25
Koken				
12222 AL	1/4"	1/4"	35	50,44
13333 AL	3/8"	3/8"	45	53,05
14444 AL	1/2"	1/2"	55	58,27
16666 AL	3/4"	3/4"	75	121,94
18888 AL	1"	1"	95	178,01

RACCORDI DI RIDUZIONE "POWER IMPACT" MASCHIO/FEMMINA

articolo	F	M	L mm	Euro
96-00	PERNO 1/4"	3/8"	32	12,47
96-0	PERNO 3/8"	1/4"	35	12,47
96-1	PERNO 3/8"	1/2"	45	12,47
96-01	PERNO 1/2"	1/4"	38	13,00
96-2	PERNO 1/2"	3/8"	45	13,56
96-3	FORO 5/8"	1/2"	50	20,07
96-4	PERNO 3/4"	1/2"	70	23,32
96-5	FORO 3/4"	5/8"	70	26,58
96-6	FORO 5/8"	3/4"	70	20,61
96-7	FORO 1/2"	5/8"	50	16,26
96-8	FORO 3/4"	1"	70	28,74
96-9	FORO 1"	3/4"	70	35,79
96-10	PERNO 1"	1/2"	70	65,00
96-11	FORO 1/2"	3/4"	50	17,89
96-12	FORO 1 1/2"	1"	115	121,80
96-13	FORO 1"	1 1/2"	115	51,51
96-14	FORO 2 1/2"	1 1/2"	115	379,60
96-15	FORO 1 1/2"	2 1/2"	120	260,30
96-16	FORO 1 1/4"	1"	140	126,00
96-17	FORO 1 3/4"	1 1/2"	150	294,00

RACCORDI DI RIDUZIONE MAGNETICI "POWER IMPACT" A SCOMPARSA - SPAZI RIDOTTI

articolo	F	M	L mm	Euro
698-00	1/4"	3/8"	17	10,00
698-0	1/4"	1/2"	22	10,00
698-1	3/8"	1/2"	22	10,50
698-11	1/2"	3/4"	30	14,70
698-8	3/4"	1"	35	21,00
698-13	1"	1 1/2"	50	31,50
698-15	1 1/2"	2 1/2"	60	210,00
698	CASSETTA 4 PZ. CONTENUTO: 1 PZ. 698-00 1 PZ. 698-1 1 PZ. 698-11 1 PZ. 698-8			63,00

RACCORDI DI RIDUZIONE "POWER IMPACT" MASCHIO/FEMMINA CON SFERA DI TENUTA NEL QUADRO MASCHIO

articolo	F	M	L mm	Euro
696-00 S	1/4"	3/8"	26	10,00
696-0 S	3/8"	1/4"	32	10,00
696-01 S	1/2"	1/4"	36	10,00
696-1 S	3/8"	1/2"	36	10,00
696-2 S	1/2"	3/8"	38	10,50
696-11 S	1/2"	3/4"	48	12,60
696-4 S	3/4"	1/2"	56	16,80
696-8 S	3/4"	1"	63	22,05
696-9 S	1"	3/4"	75	28,35

ARTICOLO NON SOGGETTO A GARANZIA

BGS
articolo
BGS 200

DESCRIZIONE
SET 6 PEZZI RIDUZIONI A MACCHINA

Euro
46,92

CARATTERISTICHE

- rivestimento specifico nero opaco

CONTENUTO

- 1/4" F X 3/8" M, coppia massima 60 Nm
- 3/8" F X 1/4" M, coppia massima 60 Nm
- 3/8" F X 1/2" M, coppia massima 200 Nm
- 1/2" F X 3/8" M, coppia massima 200 Nm
- 1/2" F X 3/4" M, coppia massima 500 Nm
- 3/4" F X 1/2" M, coppia massima 500 Nm

RICAMBI

articolo	DESCRIZIONE	Euro
BGS 200-LEER	CASSETTA VUOTA	5,46



RACCORDO DI RIDUZIONE QUADRO MASCHIO 3/8" E FEMMINA 1/4"

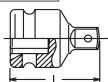

Koken articolo		L mm		Euro
12233A-P	PERNO	22	1	14,33
12233A	FORO	22	1	14,33



BGS articolo	DESCRIZIONE	Euro
BGS 25140	SET 11 PEZZI RIDUZIONI E SNODI A MACCHINA	113,48

CARATTERISTICHE

- rivestimento specifico nero opaco

CONTENUTO

- 1/4" F x 3/8" M
- 3/8" F x 1/4" M
- 3/8" F x 1/2" M
- 1/2" F x 3/8" M
- 1/2" F x 3/4" M
- 3/4" F x 1/2" M
- 3/4" F x 1" M
- 1" F x 3/4" M
- snodi da 1/4", 3/8", 1/2"



RACCORDI DI RIDUZIONE A MANDRINO CON SGANCIO RAPIDO "POWER IMPACT"

FERMEC articolo	F	M	L mm		Euro
691-0 SWF	3/8"	1/4"	55	1	31,50
691-1 SWF	3/8"	1/2"	60	1	31,50
691-2 SWF	1/2"	3/8"	55	1	36,75
691-11 SWF	1/2"	3/4"	75	1	42,00
691-4 SWF	3/4"	1/2"	70	1	42,00
691-9 SWF	1"	3/4"	90	1	73,50



SPINE ACCIAIO PER BUSSOLE

Koken articolo		L mm		Euro
1200 A	1/4"	10,2	1	0,44
1301 A	3/8"	14,5	1	0,44
1302 A	3/8"	17,5	1	0,44
1401 A	1/2"	20	1	0,74
1402 A	1/2"	25	1	0,74
1500 A	5/8"	30	1	0,74
1601 A	3/4"	35	1	0,83
1602 A	3/4"	45	1	0,94
1801 A	1"	45	1	0,94
1802 A	1"	75	1	1,82
1701 A	1 1/2"	75	1	1,98
1702 A	1 1/2"	110	1	3,99
1901 A	2 1/2"	110	1	4,46
1902 A	2 1/2"	155	1	5,06
2001 A	3 1/2"	155	1	8,36
2002 A	3 1/2"	180	1	6,90

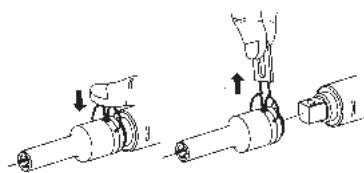
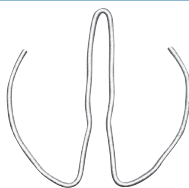

MOLLA DI SICUREZZA PER BUSSOLE

Koken articolo		Ø		Euro
1301C	3/8"	≤12	1	0,94
1302C	3/8"	>12	1	0,94
1401C	1/2"	≤14	1	1,18
1402C	1/2"	>14	1	1,18
1600C	3/4"	≤46	1	2,26
1801C	1"	≤70	1	2,23
1802C	1"	>70	1	7,87
1700C	1 1/2"	≤90	1	8,22

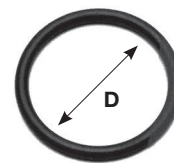

ANELLI DI GOMMA PER BUSSOLE

Koken articolo		D mm		Euro
1200 B	1/4"	9	1	0,72
1301 B	3/8"	13	1	0,83
1302 B	3/8"	16	1	0,88
1401 B	1/2"	19	1	1,02
1402 B	1/2"	24	1	1,10
1500 B	5/8"	28	1	1,35
1601 B	3/4"	36	1	1,46
1602 B	3/4"	45	1	2,15
1801 B	1"	45	1	1,98
1802 B	1"	75	1	8,72
1701 B	1 1/2"	75	1	8,58
1702 B	1 1/2"	114	1	21,42
1901 B	2 1/2"	114	1	22,25
1902 B	2 1/2"	158	1	27,72
2001 B	3 1/2"	158	1	82,80
2002 B	3 1/2"	183	1	91,88



ESTRATTORE PER MOLLE DI SICUREZZA

Koken articolo				Euro
149	3/8" - 1/2"	1	1	1,57
152	3/4" - 1"	1	1	1,68

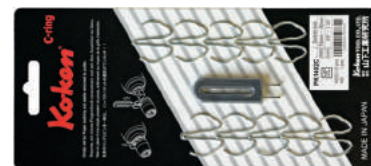

SET MOLLE DI SICUREZZA PER BUSSOLE

Koken articolo	nr.			Euro
PK1301 C-10	10	149	1	13,92
PK1302 C-10	10	149	1	13,92
PK1401 C-10	10	149	1	16,86
PK1402 C-10	10	149	1	16,86
PK1600 C-10	10	149	1	25,82
PK1801 C-10	10	149	1	26,32

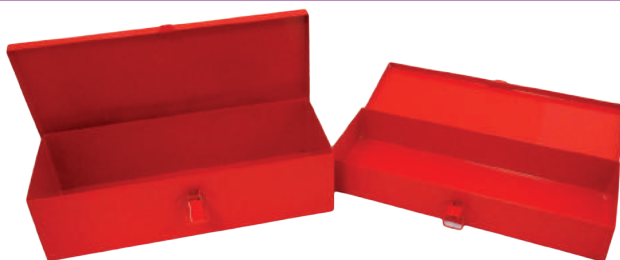

CASSETTE METALLICHE PORTA-BUSSOLE

FERMEC articolo	Dimensioni (lunghezza x larghezza x altezza) mm		Euro
CASS-2510	280 x 100 x 40 mm	1	26,25
CASS-3112	310 x 120 x 80 mm	1	39,90
CASS-3211	320 x 115 x 50 mm	1	42,00
CASS-6213	610 x 130 x 85 mm	1	55,00

NOTE

- a richiesta assortimento di bussole a macchina in cassetta metallica

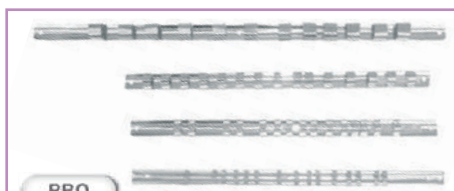

PRO

GUIDE PORTA BUSSOLE CON CLIP

BG articolo	Numero Clip	Euro
BGS 2316 1/4"	7	2,93
BGS 2317 3/8"	7	3,19
BGS 2318 1/2"	7	3,32
BGS 2120 1/4"	15	4,08
BGS 2330 3/8"	15	4,59
BGS 2540 1/2"	15	4,46
BGS 3460 3/4"	12	8,93

CARATTERISTICHE

- cromato satinato



NEW

GUIDE PORTA BUSSOLE CON CLIP

BG articolo	Numero Clip	Euro
BGS 9193 1/4"	13	3,83
BGS 9194 3/8"	11	4,08
BGS 9195 1/2"	9	4,34

CARATTERISTICHE

- clip con sfere di tenuta



GUIDE MAGNETICHE PORTA BUSSOLE CON CLIP



Koken articolo	Nr. Clip	L mm		Euro
RSAL200-1/4x12	12	200	1	37,68
RSAL200-3/8x8	8	200	1	35,56
RSAL300-3/8x12	12	300	1	42,90
RSAL300-1/2x10	10	300	1	44,85



GUIDE PORTA BUSSOLE PER MOLLE IN ACCIAIO DA 1/4" - 3/8" - 1/2" - 3/4"

Koken articolo	L mm		Euro
R 158	158	1	2,52
R 251	251	1	2,56
R 300	300	1	2,62
R 400	400	1	2,71



NEW

GUIDE MAGNETICHE PORTA BUSSOLE CON CLIP

BG articolo	Numero Clip	L mm	Euro
BGS 9342 1/4"	12	310	22,19
BGS 9343 3/8"	12	310	22,44
BGS 9344 1/2"	12	310	22,70

CARATTERISTICHE

- clip con sfera per bussole realizzate in plastica rinforzata
- magneti rivestiti in gomma protettiva



GUIDE PORTA BUSSOLE MAGNETICHE PER MOLLE IN PLASTICA





Koken articolo	L mm		Euro
RSAL-200	200	1	31,54
RSAL-300	300	1	36,63



MOLLE IN ACCIAIO PER GUIDE

Koken articolo	Euro
C 14 1/4"	0,34
C 38 3/8"	0,34
C 12 1/2"	0,34
C 34 3/4"	0,50



MOLLE IN PLASTICA PER GUIDE

Koken articolo			Euro
CLIP-1/4	1/4"	1	0,55
CLIP-3/8	3/8"	1	0,55
CLIP-1/2	1/2"	1	0,55

**GUIDA MAGNETICA PER MOLLE PORTA
BUSSOLE DA 1/4" - 3/8" - 1/2" - 3/4"**

FERMEC articolo	L mm		Euro
MAG300	300	1	20,50

BARRA PORTABUSSOLE MAGNETICA,

BGS articolo		Numero vani	Euro
BGS 3011-1	1/4"	10	5,36
BGS 3011-2	3/8"	12	8,16
BGS 3011-3	1/2"	10	11,09

CARATTERISTICHE

- le bussole sono trattenute grazie ad una banda magnetica



1/4" 3/8" 1/2" 3/4" 1"

CLIP X ATTACCO QUADRO FEMMINA

BGS articolo		Euro
BGS HANGER-1	1/4"	1,91
BGS HANGER-2	3/8"	1,91
BGS HANGER-3	1/2"	1,91
BGS HANGER-4	3/4"	2,04
BGS HANGER-5	1"	2,04

CARATTERISTICHE

- clip in plastica con quadro maschio
- ad esempio per esposizione bussole

NOTE



ESAGONO

CHIAVI A BUSSOLA A
MANO BOCCA ESAGONALE

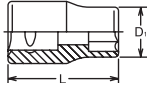

Koken articolo	mm	D ₁ mm	L mm		Euro
3400M-5	5	8.3	26	1	4,46
3400M-5,5	5,5	8.9	26	1	4,46
3400M-6	6	9.9	26	1	4,46
3400M-7	7	10.8	26	1	4,46
3400M-8	8	12	26	1	4,46
3400M-9	9	13.3	26	1	4,46
3400M-10	10	14.5	26	1	4,46
3400M-11	11	15.8	26	1	4,46
3400M-12	12	16.8	26	1	4,46
3400M-13	13	18	26	1	5,12
3400M-14	14	19.5	27	1	5,17
3400M-15	15	20.8	28	1	5,28
3400M-16	16	22	28	1	5,28
3400M-17	17	23.3	29	1	5,28
3400M-18	18	24.5	30	1	5,53
3400M-19	19	25.8	30	1	5,53
3400M-20	20	27	31	1	6,79
3400M-21	21	28	32	1	6,79
3400M-22	22	29.5	32	1	6,79
3400M-23	23	30.8	33	1	7,48
3400M-24	24	32	34	1	7,76
NEW 3400M-25	25	33.3	34	1	12,02
NEW 3400M-26	26	34.5	35	1	12,02



POLIGONALE

CHIAVI A BUSSOLA A
MANO BOCCA POLIGONALE

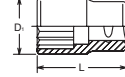

Koken articolo	mm	D ₁ mm	L mm		Euro
3405M-5	5	9.9	26	1	4,46
3405M-5.5	5.5	9.9	26	1	4,46
3405M-6	6	9.9	26	1	4,46
3405M-7	7	10.8	26	1	4,46
3405M-8	8	12	26	1	4,46
3405M-9	9	13.3	26	1	4,46
3405M-10	10	14.5	26	1	4,46
3405M-11	11	15.8	26	1	4,46
3405M-12	12	16.8	26	1	4,46
3405M-13	13	18	26	1	5,12
3405M-14	14	19.5	27	1	5,17
3405M-15	15	20.8	28	1	5,28
3405M-16	16	22	28	1	5,28
3405M-17	17	23.3	29	1	5,28
3405M-18	18	24.5	30	1	5,53
3405M-19	19	25.8	30	1	5,53
3405M-20	20	27	31	1	6,79
3405M-21	21	28	32	1	6,79
3405M-22	22	29.5	32	1	6,79
3405M-23	23	30.8	33	1	7,48
3405M-24	24	32	34	1	7,76
NEW 3405M-25	25	33.3	34	1	12,02
NEW 3405M-26	26	34.5	35	1	12,02

POLLICI



ESAGONO

CHIAVI A BUSSOLA A
MANO BOCCA ESAGONALE

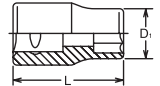

Koken articolo	pollici	D ₁ mm	L mm		Euro
3400A-3/16	3/16"	8.3	26	1	4,79
3400A-1/4	1/4"	10.3	26	1	4,79
3400A-9/32	9/32"	10.8	26	1	4,79
3400A-5/16	5/16"	12	26	1	4,79
3400A-11/32	11/32"	13.3	26	1	4,79
3400A-3/8	3/8"	13.9	26	1	4,79
NEW 3400A-13/32	13/32"	13.3	26	1	4,79
3400A-7/16	7/16"	15.8	26	1	4,79
3400A-1/2	1/2"	18	26	1	5,53
3400A-9/16	9/16"	19.5	27	1	5,58
3400A-19/32	19/32"	20.8	28	1	5,69
3400A-5/8	5/8"	22	28	1	5,69
3400A-11/16	11/16"	24.5	30	1	5,94
3400A-3/4	3/4"	25.8	30	1	5,94
3400A-25/32	25/32"	27	31	1	7,34
3400A-13/16	13/16"	28	32	1	7,34
3400A-7/8	7/8"	29.5	32	1	7,34
3400A-15/16	15/16"	32	34	1	8,33
NEW 3400A-1	1"	34.5	35	1	12,60

POLLICI



POLIGONALE

CHIAVI A BUSSOLA A
MANO BOCCA POLIGONALE

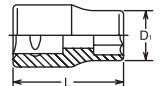

Koken articolo	pollici	D ₁ mm	L mm		Euro
3405A-3/16	1/16"	8.3	26	1	4,79
3405A-1/4	1/4"	10.3	26	1	4,79
3405A-9/32	9/32"	10.8	26	1	4,79
3405A-5/16	5/16"	12	26	1	4,79
3405A-11/32	11/32"	13.3	26	1	4,79
3405A-3/8	3/8"	13.9	26	1	4,79
NEW 3405A-13/32	13/32"	13.3	26	1	4,79
3405A-7/16	7/16"	15.8	26	1	4,79
3405A-1/2	1/2"	18	26	1	5,53
3405A-9/16	9/16"	19.5	27	1	5,58
3405A-19/32	19/32"	20.8	28	1	5,69
3405A-5/8	5/8"	22	28	1	5,69
3405A-11/16	11/16"	24.5	30	1	5,94
3405A-3/4	3/4"	25.8	30	1	5,94
3405A-25/32	25/32"	27	31	1	7,34
3405A-13/16	13/16"	28	32	1	7,34
3405A-7/8	7/8"	29.5	32	1	7,34
3405A-15/16	15/16"	32	34	1	8,33
NEW 3405A-1	1"	34.5	35	1	12,60



ESAGONO

CHIAVI A BUSSOLA
BOCCA ESAGONALE
PER FILTRI OLIO

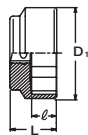

Koken articolo	mm	D ₁ mm	l mm	L mm		Euro
3400M-24-27	27	36.5	13.5	24	1	34,54
3400M-24-30	30	40	13.5	24	1	36,82
3400M-24-32	32	42.8	13.5	24	1	39,16
3400M-24-36	36	47.2	13.5	24	1	46,31



NEW



ESAGONO

FEMEC
articolo

DESCRIZIONE

Euro

FM 31032

SET 6 PEZZI, INSERTI
ANTI-GRAFFIO PER
CHIAVI A BUSSOLA
ESAGONALI



8,00

CARATTERISTICHE

- inserti speciali che, utilizzati all'interno delle bussole esagonali tradizionali, consentono di prevenire danni a parti cromate o verniciate o, più in generale, con trattamenti superficiali
- comprende:
 - inserto 8 mm, per bussola 12 mm, coppia 9 Nm
 - inserto 10 mm, per bussola 14 mm, coppia 17 Nm
 - inserto 12 mm, per bussola 16 mm, coppia 27 Nm
 - inserto 13 mm, per bussola 17 mm, coppia 45 Nm
 - inserto 15 mm, per bussola 19 mm, coppia 50 Nm
 - inserto 17 mm, per bussola 22 mm, coppia 79 Nm
- per uso con bussole esagonali metriche

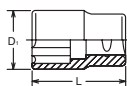



SURFACE DRIVE
**CHIAVI A BUSSOLA
A MANO BOCCA
SURFACE DRIVE**

Koken articolo	 mm	D ₁ mm	L mm		Euro
3410M-5.5	5.5	8.9	26	1	5,39
3410M-6	6	9.9	26	1	4,65
3410M-7	7	10.8	26	1	4,65
3410M-8	8	12	26	1	4,65
3410M-9	9	13.3	26	1	4,65
3410M-10	10	14.5	26	1	4,65
3410M-11	11	15.8	26	1	4,65
3410M-12	12	16.8	26	1	4,65
3410M-13	13	18	26	1	4,65
3410M-14	14	19.5	27	1	5,45
3410M-15	15	20.8	28	1	5,53
3410M-16	16	22	28	1	5,53
3410M-17	17	23.3	29	1	5,53
3410M-18	18	24.5	30	1	5,80
3410M-19	19	25.8	30	1	5,80
3410M-20	20	27	31	1	7,15
3410M-21	21	28	32	1	7,15
3410M-22	22	29.5	32	1	7,15
3410M-23	23	30.8	33	1	7,84
3410M-24	24	32	34	1	8,11

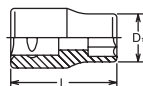



**OTTAGONALE
OTTO ANGOLI**
**CHIAVI A BUSSOLA A MANO
BOCCA OTTAGONALE**

Koken articolo	 mm	D ₁ mm	L mm		Euro
NEW 3415M-5.5	5.5	10.8	21	1	10,09
3415M-6	6	12	26	1	6,00
NEW 3415M-7	7	13.3	26	1	6,00
3415M-8	8	14.5	26	1	6,00
3415M-10	10	16.8	26	1	6,38
3415M-12	12	20.8	27	1	6,90
NEW 3415M-13	6	21.9	27	1	14,22

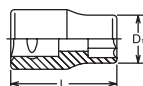

POLLICI

**OTTAGONALE
OTTO ANGOLI**
**CHIAVI A BUSSOLA A MANO
BOCCA OTTAGONALE**

Koken articolo	 pollici	D ₁ mm	L mm		Euro
3415A-1/4	1/4"	12	26	1	6,41
3415A-5/16	5/16"	14.5	26	1	6,41
3415A-11/32	11/32"	15.8	26	1	6,88
3415A-3/8	3/8"	16.8	26	1	6,88
3415A-7/16	7/16"	19.5	27	1	7,43
3415A-1/2	1/2"	22	27	1	7,43

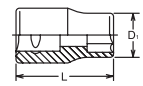

TORX
**CHIAVI A BUSSOLA A
MANO BOCCA TORX®**



Koken articolo	 mm	D ₁ mm	L mm		Euro
3425-E 4	E 4	17.3	26	1	5,50
3425-E 5	E 5	17.3	26	1	5,50
3425-E 6	E 6	17.3	26	1	5,50
3425-E 7	E 7	17.3	26	1	5,50
3425-E 8	E 8	17.3	26	1	5,50
3425-E10	E10	17.3	26	1	5,50
3425-E11	E11	17.3	26	1	5,64
3425-E12	E12	17.3	26	1	5,64
3425-E14	E14	17.3	26	1	5,64
3425-E16	E16	17	26	1	5,83

TORX®
S
mm
S
mm

E 4	3.70	E 16	14.60
E 5	4.60	E 18	16.50
E 6	5.60	E 20	18.30
E 7	6.10	E 22	20.10
E 8	7.40	E 24	22.00
E 10	9.30	E 26	23.70
E 11	9.90	E 28	25.50
E 12	11.00	E 30	27.30
E 14	12.80	E 32	29.00

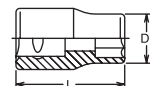
S
mm
S
mm
S
mm
S
mm
S
mm
S
mm
S
mm
S
mm
S
mm
S
mm
S
mm
S
mm
S
mm
S
mm
S
mm
S
mm
S
mm
S
mm
S
mm
S
mm
S
mm
S
mm
S
mm
S
mm
S
mm
S
mm
S
mm
S
mm
S
mm
S
mm
S
mm
S
mm
S
mm
S
mm
S
mm
S
mm
S
mm
S
mm
S
mm
S
mm
S
mm
S
mm
S
mm
S
mm
S
mm
S
mm
S
mm
S
mm
S
mm
S
mm
S
mm
S
mm
S
mm
S
mm
S
mm
S
mm
S
mm
S
mm
S
mm
S
mm
S
mm
S
mm
S
mm
S
mm
S
mm
S
mm
S
mm

SYSTEM 6
**CHIAVI A BUSSOLA
A MANO BOCCA
SYSTEM 6**

Koken articolo	 S	D mm	L mm		Euro
3400LH-5S	5 S	17.3	26	1	9,13
3400LH-6S	6 S	17.3	26	1	9,13
3400LH-8S	8 S	17.3	26	1	9,13
3400LH-10S	10 S	17.3	26	1	9,13
3400LH-12S	12 S	17.3	28	1	9,52
3400LH-14S	14 S	17.3	30	1	10,26
3400LH-16S	16 S	17	32	1	11,66

LHSTIX®
d
mm
D
mm

LH 3 S	3.80	4.70
LH 4 S	4.50	6.00
LH 5 S	5.60	7.50
LH 6 S	6.80	9.00
LH 7 S	7.90	10.50
LH 8 S	9.00	12.00
LH 10 S	11.30	15.00
LH 12 S	13.60	18.00
LH 14 S	15.80	21.00
LH 16 S	18.10	24.00

d
mm
D
mm
d
mm
D
mm
d
mm
D
mm
d
mm
D
mm
d
mm
D
mm
d
mm
D
mm
d



CHIAVI A BUSSOLA A MANO BOCCA NUT GRIP® BLOCCADADI

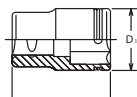

Koken articolo	mm	D mm	L mm	Euro
3450M-8	8	12	26	9,16
3450M-10	10	14.5	26	9,16
3450M-11	11	15.8	26	9,16
3450M-12	12	16.8	26	9,16
3450M-13	13	18	26	9,35
3450M-14	14	19.5	27	9,35
3450M-15	15	20.8	27	9,46
3450M-16	16	22	27	9,38
3450M-17	17	23.3	28	9,38
3450M-18	18	24.5	29	9,93
3450M-19	19	25.8	29	9,93
3450M-21	21	28	29	10,34
3450M-22	22	29.5	29	10,53
3450M-24	24	32	31	11,80



SERIE 8 PZ. CHIAVI A BUSSOLA BOCCA ESAGONALE EXTRA CORTE

Koken articolo	mm	Euro
RS3400MZ/8	8, 10, 11, 12, 13, 14, 17, 19	81,62



CHIAVI A BUSSOLA A MANO BOCCA ESAGONALE SEMI LUNGHE

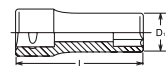

Koken articolo	mm	D ₁ mm	L mm	Euro
3300X-8	8	12	40	9,02
3300X-9	9	13	40	9,02
3300X-10	10	14.5	40	9,02
3300X-11	11	16	40	9,02
3300X-12	12	16.8	40	9,02
3300X-13	13	18	40	10,15
3300X-14	14	20	40	10,15
3300X-15	15	21	40	10,31
3300X-16	16	22	40	10,31
3300X-17	17	23.5	40	10,31
3300X-18	18	24.5	40	11,28
3300X-19	19	25	40	11,28



SERIE 9 PZ. CHIAVI A BUSSOLA BOCCA TORX®

Koken articolo	Euro
RS3425/9	48,70



SERIE 14 PZ. CHIAVI A BUSSOLA BOCCA TORX®

Koken articolo	Euro
RSX425/14	73,98

CONTENUTO

- 1/4" E4, E5, E6, E7, E8
- 3/8" E10, E11, E12, E14
- 1/2" E16, E18, E20, E22, E24



CHIAVI A BUSSOLA A MANO BOCCA POLIGONALE SEMI LUNGHE

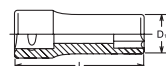

Koken articolo	mm	D ₁ mm	L mm	Euro
3305X-8	8	12	40	9,02
3305X-9	9	13	40	9,02
3305X-10	10	14.5	40	9,02
3305X-11	11	16	40	9,02
3305X-12	12	16.8	40	9,02
3305X-13	13	18	40	10,15
3305X-14	14	20	40	10,15
3305X-15	15	21	40	10,31
3305X-16	16	22	40	10,31
3305X-17	17	23.5	40	10,31
3305X-18	18	24.5	40	11,28
3305X-19	19	25	40	11,28



SERIE 9 PZ. CHIAVI A BUSSOLA MISURE: 1/4", 5/16", 3/8", 7/16", 1/2" 9/16", 5/8", 11/16", 3/4" DISPONIBILI CON BOCCA: ESAGONALE/POLIGONALE

Koken articolo	Euro
RS3400A/9	46,17
RS3405A/9	44,99



SERIE 7 PZ. CHIAVI A BUSSOLA MASCHIO SYSTEM 6

Koken articolo	Euro
RS3400LH/7	62,51



KOKEN 3/8"





ESAGONO

**CHIAVI A BUSSOLA
A MANO BOCCA
ESAGONALE LUNGHE**



Koken articolo	mm	D ₁ mm	L mm		Euro
3300M-5.5	5.5	8.9	55	1	8,83
3300M-6	6	9.9	55	1	8,83
3300M-7	7	10.6	55	1	8,83
3300M-8	8	12	55	1	8,83
3300M-9	9	13	55	1	8,83
3300M-10	10	14.5	55	1	8,83
3300M-11	11	16	55	1	8,83
3300M-12	12	16.8	55	1	8,83
3300M-13	13	18	55	1	9,90
3300M-14	14	20	55	1	9,90
3300M-15	15	21	55	1	9,98
3300M-16	16	22	55	1	9,98
3300M-17	17	23.5	55	1	9,98
3300M-18	18	24.5	55	1	11,58
3300M-19	19	25	55	1	11,58
3300M-20	20	26	65	1	13,42
3300M-21	21	27	65	1	13,42
3300M-22	22	29	65	1	13,86
3300M-23	23	30	65	1	14,11
3300M-24	24	31	65	1	16,14
3300M-25	25	33	65	1	18,34
3300M-26	26	34	65	1	18,34
3300M-27	27	35	65	1	18,34



ESAGONO

**CHIAVI A BUSSOLA
A MANO BOCCA
ESAGONALE
EXTRA LUNGHE**



Koken articolo	mm	D ₁ mm	L mm		Euro
3300M-120-8	8	12	120	1	37,21
3300M-120-10	10	14.5	120	1	37,21
3300M-120-12	12	16.8	120	1	37,21
3300M-120-13	13	18	120	1	39,46
3300M-120-14	14	20	120	1	40,87

3/8



**CHIAVI A BUSSOLA
A MANO BOCCA
ESAGONALE
PER INIETTORI**

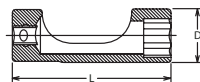

Koken articolo	mm	D ₁ mm	L mm		Euro
3300FN-8	8	14.5	53	1	43,31
3300FN-9	9	16	53	1	43,31
3300FN-10	10	16.8	53	1	43,31
3300FN-11	11	18	53	1	43,31
3300FN-12	12	20	53	1	43,31
3300FN-13	13	21.1	62	1	44,17
3300FN-14	14	22	62	1	44,99
3300FN-15	15	23	70	1	45,40
3300FN-16	16	24	70	1	45,93
3300FN-17	17	25	80	1	46,26
3300FN-18	18	27	80	1	47,82
3300FN-19	19	28	80	1	48,13
3300FN-22	22	32	80	1	65,07
3300FN-24	24	34.5	80	1	68,28



3/8

**SERIE 8 PZ. CHIAVI A BUSSOLA
BOCCA ESAGONALE PER INIETTORI**

Koken articolo	mm		Euro
RS3300FN/8	9, 10, 11, 13, 14, 16, 17, 19	1	347,52



3/8"

ESAGONO

CV PRO+

BGS articolo	DESCRIZIONE	Euro
BGS 9863	SET 5 PEZZI, BUSSOLE ESAGONALI 8-14 MM, ATT. 3/8", EXTRA LUNGHE	95,00

CARATTERISTICHE

- misure: 8-10-12-13-14 mm
- finitura cromata lucida
- attacco quadro 3/8"
- esagonali
- **lunghezza: 120 mm**



POLIGONALE

**CHIAVI A BUSSOLA
A MANO BOCCA
POLIGONALE LUNGHE**



Koken articolo	mm	D ₁ mm	L mm		Euro
3305M-5.5	5.5	8.9	55	1	8,83
3305M-6	6	9.9	55	1	8,83
3305M-7	7	10.6	55	1	8,83
3305M-8	8	12	55	1	8,83
3305M-9	9	13	55	1	8,83
3305M-10	10	14.5	55	1	8,83
3305M-11	11	16	55	1	8,83
3305M-12	12	16.8	55	1	8,83
3305M-13	13	18	55	1	9,90
3305M-14	14	20	55	1	9,90
3305M-15	15	21	55	1	9,98
3305M-16	16	22	55	1	9,98
3305M-17	17	23.5	55	1	9,98
3305M-18	18	24.5	55	1	11,58
3305M-19	19	25	55	1	11,58
3305M-20	20	26	65	1	13,42
3305M-21	21	27	65	1	13,42
3305M-22	22	29	65	1	13,86
3305M-23	23	30	65	1	14,11
3305M-24	24	31	65	1	16,14
3305M-25	25	33	65	1	18,34
3305M-26	26	34	65	1	18,34
3305M-27	27	35	65	1	18,34



POLIGONALE

**CHIAVI A BUSSOLA
A MANO BOCCA
POLIGONALE
EXTRA LUNGHE**



Koken articolo	mm	D ₁ mm	L mm		Euro
3305M-120-8	8	12	120	1	37,21
3305M-120-10	10	14.5	120	1	37,21
3305M-120-12	12	16.8	120	1	37,21
3305M-120-13	13	18	120	1	39,46
3305M-120-14	14	20	120	1	40,87



POLLICI



CHIAVI A BUSSOLA
A MANO BOCCA
ESAGONALE LUNGHE

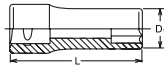

Koken articolo	pollici	D ₁ mm	L mm		Euro
3300A-7/32	7/32"	8.9	55	1	9,54
3300A-1/4	1/4"	9.9	55	1	9,54
3300A-5/16	5/16"	12	55	1	9,54
3300A-11/32	11/32"	12.3	55	1	9,54
3300A-3/8	3/8"	14	55	1	9,54
3300A-7/16	7/16"	16	55	1	9,54
3300A-1/2	1/2"	18	55	1	10,64
3300A-9/16	9/16"	20	55	1	10,64
3300A-19/32	19/32"	21	55	1	10,78
3300A-5/8	5/8"	22	55	1	10,78
3300A-11/16	11/16"	23.5	55	1	11,96
3300A-3/4	3/4"	25	55	1	12,49
3300A-13/16	13/16"	27	65	1	14,49
3300A-7/8	7/8"	29	65	1	14,96
3300A-15/16	15/16"	31	65	1	17,38



CHIAVI A BUSSOLA
A MANO BOCCA
SURFACE DRIVE

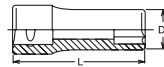

Koken articolo	mm	D ₁ mm	L mm		Euro
3310M-6	6	9.9	55	1	9,30
3310M-7	7	10.6	55	1	9,30
3310M-8	8	12	55	1	9,30
3310M-9	9	13	55	1	9,30
3310M-10	10	14.5	55	1	9,30
3310M-11	11	16	55	1	9,30
3310M-12	12	16.8	55	1	9,30
3310M-13	13	18	55	1	10,40
3310M-14	14	20	55	1	10,40
3310M-15	15	21	55	1	10,51
3310M-16	16	22	55	1	10,51
3310M-17	17	23.5	55	1	10,51
3310M-18	18	24.5	55	1	12,18
3310M-19	19	25	55	1	12,18
3310M-20	20	26	65	1	14,11
3310M-21	21	27	65	1	14,11
3310M-22	22	29	65	1	14,58
3310M-23	23	30	65	1	14,85
3310M-24	24	31	65	1	16,94

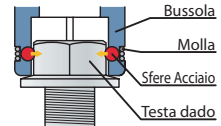

CHIAVI A BUSSOLA
A MANO BOCCA NUT
GRIP® EXTRA LUNGHE

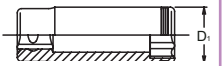

Koken articolo	mm	D ₁ mm	L mm		Euro
3350M-L120-10	10	14.5	120	1	50,55
3350M-L120-12	12	16.8	120	1	50,55



SERIE 12 PZ. CHIAVI A BUSSOLA LUNGHE
MISURE: 8, 9, 10, 11, 12, 13, 14, 15, 16
17, 18, 19 MM

DISPONIBILI CON BOCCA:
ESAGONALE/POLIGONALE

Koken articolo				Euro
RS3300M/12			1	114,18
RS3305M/12			1	114,18

POLLICI



CHIAVI A BUSSOLA
A MANO BOCCA
POLIGONALE LUNGHE

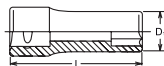

Koken articolo	pollici	D ₁ mm	L mm		Euro
3305A-7/32	7/32"	8.9	55	1	9,54
3305A-1/4	1/4"	9.9	55	1	9,54
3305A-5/16	5/16"	12	55	1	9,54
3305A-11/32	11/32"	12.3	55	1	9,54
3305A-3/8	3/8"	14	55	1	9,54
3305A-7/16	7/16"	16	55	1	9,54
3305A-1/2	1/2"	18	55	1	10,23
3305A-9/16	9/16"	20	55	1	10,23
3305A-19/32	19/32"	21	55	1	10,78
3305A-5/8	5/8"	22	55	1	10,78
3305A-11/16	11/16"	23.5	55	1	11,96
3305A-3/4	3/4"	25	55	1	12,49
3305A-13/16	13/16"	27	65	1	14,49
3305A-7/8	7/8"	29	65	1	14,96
3305A-15/16	15/16"	31	65	1	17,38



CHIAVI A BUSSOLA
A MANO BOCCA TORX®

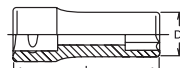

Koken articolo		D ₁ mm	L mm		Euro
3325-E 4	E 4	5.6	55	1	11,80
3325-E 5	E 5	6.9	55	1	11,80
3325-E 6	E 6	7.9	55	1	11,80
3325-E 7	E 7	8.9	55	1	11,80
3325-E 8	E 8	9.9	55	1	11,80
3325-E10	E10	11.8	55	1	11,80
3325-E11	E11	11.8	55	1	11,80
3325-E12	E12	14.5	55	1	11,80
3325-E14	E14	15.7	55	1	11,80
3325-E16	E16	18	55	1	12,43



CHIAVI A BUSSOLA A
MANO BOCCA NUT GRIP®

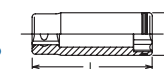

Koken articolo	mm	D ₁ mm	L mm		Euro
3350M-8	8	12	55	1	16,25
3350M-10	10	14.5	55	1	16,25
3350M-12	12	16.8	55	1	16,25
3350M-13	13	18	55	1	17,22
3350M-14	14	19.5	55	1	17,22

POLLICI



SERIE 9 PZ. CHIAVI A BUSSOLA LUNGHE
MISURE: 1/4", 5/16", 3/8", 7/16", 1/2", 9/16",
5/8", 11/16", 3/4"

DISPONIBILI CON BOCCA:
ESAGONALE/POLIGONALE

Koken articolo				Euro
RS3300A/9			1	92,29
RS3305A/9			1	92,29





SERIE 9 PZ. CHIAVI A BUSSOLA BOCCA TORX®

Koken articolo			Euro
RS3325/9	E4, E5, E6, E7, E8, E10, E12, E14, E16	1	103,13

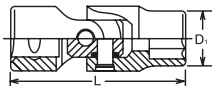

CHIAVI A BUSSOLA A
MANO SNODATE
BOCCA ESAGONALE





Koken articolo	mm	D ₁ mm	L mm		Euro
3440M-8	8	12	47	1	23,98
3440M-9	9	13.3	47.5	1	23,98
3440M-10	10	14.5	48.5	1	23,98
3440M-11	11	15.8	49.5	1	23,98
3440M-12	12	17	50	1	23,98
3440M-13	13	18.3	51	1	23,98
3440M-14	14	19.5	51	1	25,03
3440M-15	15	20.8	53.5	1	25,03
3440M-16	16	22	53.5	1	25,03
3440M-17	17	23.3	54.5	1	25,36
3440M-18	18	24.5	54.5	1	26,29
3440M-19	19	25.8	56.5	1	26,29
3440M-21	21	28.3	56.5	1	30,20

POLLICI

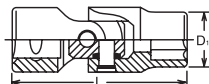

CHIAVI A BUSSOLA A
MANO SNODATE
BOCCA ESAGONALE



Koken articolo	pollici	D ₁ mm	L mm		Euro
3440A-5/16	5/16"	12	47	1	25,85
3440A-3/8	3/8"	14	48	1	25,85
3440A-7/16	7/16"	15.8	49.5	1	25,85
3440A-1/2	1/2"	18.3	51	1	25,85
3440A-9/16	9/16"	19.5	51	1	26,98
3440A-5/8	5/8"	22	53.5	1	26,98
3440A-11/16	11/16"	24.5	54.5	1	28,33
3440A-3/4	3/4"	25.8	56.5	1	28,33



CHIAVI A BUSSOLA A
MANO SNODATE
BOCCA ESAGONALE



Koken articolo	mm	D ₁ mm	L mm		Euro
3340M-75-8	8	12	75	1	32,09
3340M-75-9	9	12	75	1	32,09
3340M-75-10	10	14.5	75	1	32,09
3340M-75-11	11	15.8	75	1	32,09
3340M-75-12	12	17	75	1	32,09
3340M-75-13	13	18.3	75	1	32,09
3340M-75-14	14	19.5	75	1	33,22
3340M-75-15	15	20.8	75	1	33,61
3340M-75-16	16	22	75	1	33,61
3340M-75-17	17	23.3	75	1	33,61
3340M-75-18	18	24.5	75	1	34,27
3340M-75-19	19	25.8	75	1	34,27



CHIAVI A BUSSOLA A
MANO SNODATE
BOCCA POLIGONALE

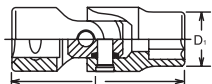



Koken articolo	mm	D ₁ mm	L mm		Euro
3445M-8	8	12	47	1	23,98
3445M-9	9	13.3	47.5	1	23,98
3445M-10	10	14.5	48.5	1	23,98
3445M-11	11	15.8	49.5	1	23,98
3445M-12	12	17	50	1	23,98
3445M-13	13	18.3	51	1	23,98
3445M-14	14	19.5	51	1	25,03
3445M-15	15	20.8	53.5	1	25,03
3445M-16	16	22	53.5	1	25,03
3445M-17	17	23.3	54.5	1	25,36
3445M-18	18	24.5	54.5	1	26,29
3445M-19	19	25.8	56.5	1	26,29
3445M-21	21	28.3	56.5	1	30,20

POLLICI

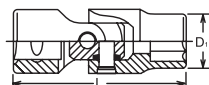

CHIAVI A BUSSOLA A
MANO SNODATE
BOCCA POLIGONALE



Koken articolo	pollici	D ₁ mm	L mm		Euro
3445A-5/16	5/16"	12	47	1	25,85
3445A-3/8	3/8"	14	48	1	25,85
3445A-7/16	7/16"	15.8	49.5	1	25,85
3445A-1/2	1/2"	18.3	51	1	25,85
3445A-9/16	9/16"	19.5	51	1	26,98
3445A-5/8	5/8"	22	53.5	1	26,98
3445A-11/16	11/16"	24.5	54.5	1	28,33
3445A-3/4	3/4"	25.8	56.5	1	28,33



CHIAVI A BUSSOLA A
MANO SNODATE CON
SFERE DI TENUTA
BOCCA **NUT GRIP**





Koken articolo	mm	D ₁ mm	L mm		Euro
3441M-8	8	12	46	1	40,01
3441M-10	10	14.5	46	1	40,01
3441M-12	12	16.8	47	1	40,01
3441M-13	13	18	48	1	40,01
3441M-14	14	19.5	49.5	1	40,01



CHIAVI A BUSSOLA A
MANO SNODATE
BOCCA TORX®



Koken articolo		D ₁ mm	L mm		Euro
3440T-E 6	E 6	7.9	44.5	1	28,33
3440T-E 8	E 8	9.9	46	1	28,33
3440T-E10	E10	11.8	47	1	28,33
3440T-E12	E12	14.5	48.5	1	28,33
3440T-E14	E14	15.7	49	1	28,33
3440T-E16	E16	18	50	1	30,42
3440T-E18	E18	19.5	53	1	30,42
3440T-E20	E20	22	54	1	31,57

TORX®

	S mm	S mm	
E 4	3.70	E 16	14.60
E 5	4.60	E 18	16.50
E 6	5.60	E 20	18.30
E 7	6.10	E 22	20.10
E 8	7.40	E 24	22.00
E 10	9.30	E 26	23.70
E 11	9.90	E 28	25.50
E 12	11.00	E 30	27.30
E 14	12.80	E 32	29.00





NUT GRIP® BLOCCADADI

SERIE 5 PZ. CHIAVI A BUSSOLA A MANO
SNODATE CON SFERE DI TENUTA
BOCCA NUT GRIP

Koken articolo	mm		Euro
RS3441M/5	8, 10, 12, 13, 14	1	195,11



CHIAVI A BUSSOLA A CROCE PHILLIPS®

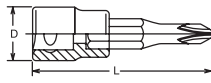

Koken articolo		D mm	L mm		Euro
3000-60 (PH)-1	PH1	18	60	1	9,30
3000-60 (PH)-2	PH2	18	60	1	9,30
3000-60 (PH)-3	PH3	18	60	1	9,30
3000-60 (PH)-4	PH4	18	60	1	9,30



CHIAVI A BUSSOLA MASCHIO ESAGONALE

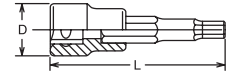

Koken articolo	mm	D mm	L mm		Euro
3010M-38-3	3	18	38	1	8,47
3010M-38-4	4	18	38	1	8,47
3010M-38-5	5	18	38	1	8,47
3010M-38-6	6	18	38	1	8,47
3010M-38-7	7	18	38	1	8,47
3010M-38-8	8	18	38	1	8,47
3010M-38-9	9	20	38	1	8,97
3010M-38-10	10	20	38	1	9,30
3010M-38-11	11	20	38	1	9,30
3010M-38-12	12	20	38	1	9,30
3010M-38-13	13	22	38	1	11,39
3010M-38-14	14	22	38	1	11,39



POLIGONALE

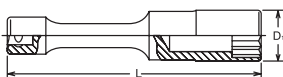

CHIAVI A BUSSOLA A MANO BOCCA POLIGONALE TIPO LUNGO

Koken articolo	mm	D ₁ mm	L mm		Euro
3117M-125-10	10	14.5	125	1	23,98
3117M-125-11	11	16	125	1	23,98
3117M-125-12	12	17	125	1	23,98
3117M-125-13	13	18	125	1	23,98
3117M-125-14	14	19.5	125	1	23,98
3117M-125-17	17	23.5	125	1	23,98
3117M-125-19	19	25	125	1	25,49
3117M-125-21	21	27	125	1	27,25
3117M-125-22	22	29	125	1	27,83
3117M-250-10	10	14.5	250	1	27,14
3117M-250-11	11	16	250	1	27,14
3117M-250-12	12	17	250	1	27,14
3117M-250-13	13	18	250	1	27,14
3117M-250-14	14	19.5	250	1	27,14
3117M-250-17	17	23.5	250	1	27,14
3117M-250-19	19	25	250	1	29,40
3117M-250-21	21	27	250	1	30,22
3117M-250-22	22	29	250	1	30,97



CHIAVI A BUSSOLA A CROCE POZIDRIV®

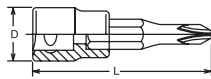

Koken articolo		D mm	L mm		Euro
3000-50 (PZ)-1	PZ1	18	50	1	10,56
3000-50 (PZ)-2	PZ2	18	50	1	10,56
3000-50 (PZ)-3	PZ3	18	50	1	10,56



3010M-62-3	3	18	62	1	8,86
3010M-62-4	4	18	62	1	8,86
3010M-62-5	5	18	62	1	8,86
3010M-62-6	6	18	62	1	8,86
3010M-62-7	7	18	62	1	9,24
3010M-62-8	8	18	62	1	9,24
3010M-62-9	9	20	62	1	9,57
3010M-62-10	10	20	62	1	10,01
3010M-62-11	11	20	62	1	10,01
3010M-62-12	12	20	62	1	10,01
3010M-62-13	13	22	62	1	11,74
3010M-62-14	14	22	62	1	11,74
3010M-100-3	3	18	100	1	9,63
3010M-100-4	4	18	100	1	9,63
3010M-100-5	5	18	100	1	9,71
3010M-100-6	6	18	100	1	9,71
3010M-100-7	7	18	100	1	10,04
3010M-100-8	8	18	100	1	10,04
3010M-100-9	9	20	100	1	10,23
3010M-100-10	10	20	100	1	10,23
3010M-100-11	11	20	100	1	11,19
3010M-100-12	12	20	100	1	11,19
3010M-100-13	13	22	100	1	12,73
3010M-100-14	14	22	100	1	12,73
3010M-160-3	3	18	160	1	11,36
3010M-160-4	4	18	160	1	11,36
3010M-160-5	5	18	160	1	11,36
3010M-160-6	6	18	160	1	11,36
3010M-160-7	7	18	160	1	12,13
3010M-160-8	8	18	160	1	12,13
3010M-160-9	9	20	160	1	13,28
3010M-160-10	10	20	160	1	13,28
3010M-160-11	11	20	160	1	13,75
3010M-160-12	12	20	160	1	13,75
3010M-160-13	13	22	160	1	15,15
3010M-160-14	14	22	160	1	15,15

POLLICI



ESAGONO

NEW

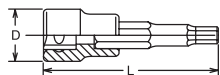
**CHIAVI A BUSSOLA
MASCHIO
ESAGONALE**

Koken articolo	pollici	D mm	L mm		Euro
3010A-50-1/8	1/8"	18	50	1	10,23
3010A-50-5/32	5/32"	18	50	1	10,23
3010A-50-3/16	3/16"	18	50	1	10,23
3010A-50-7/32	7/32"	18	50	1	10,23
3010A-50-1/4	1/4"	18	50	1	10,23
3010A-50-9/32	9/32"	18	50	1	10,78
3010A-50-5/16	5/16"	18	50	1	10,78
3010A-50-11/32	11/32"	20	50	1	11,17
3010A-50-3/8	3/8"	20	50	1	11,17
3010A-50-7/16	7/16"	20	50	1	11,58
3010A-50-1/2	1/2"	22	50	1	12,98

**CHIAVI A BUSSOLA
MASCHIO ESAGONALE
INTEGRALI**

ESAGONO

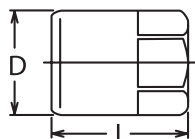

Koken articolo	mm	D mm	L mm		Euro
3012M-25-3	3	18.5	25	1	12,43
3012M-25-4	4	18.5	25	1	12,43
3012M-25-5	5	18.5	25	1	12,43
3012M-25-6	6	18.5	25	1	12,43
3012M-25-7	7	18.5	25	1	12,43
3012M-25-8	8	18.5	25	1	12,43
3012M-25-10	10	18.5	25	1	12,43
3012M-25-12	12	19	25	1	12,43
3012M-25-14	14	19	25	1	12,43
3012M-25-17	17	19	25	1	12,43

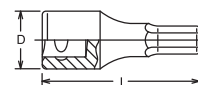
**CHIAVI A BUSSOLA
MASCHIO ESAGONALE
INTEGRALI**

Koken articolo	mm	D mm	L mm		Euro
3012M-52-3	3	18	52	1	10,34
3012M-52-4	4	18	52	1	10,34
3012M-52-5	5	18	52	1	10,34
3012M-52-6	6	18	52	1	10,34
3012M-52-7	7	18	52	1	10,51
3012M-52-8	8	18.5	52	1	10,51
3012M-52-9	9	18.5	52	1	11,17
3012M-52-10	10	20	52	1	11,17
3012M-52-11	11	20	52	1	11,47
3012M-52-12	12	20	52	1	11,47
3012M-52-13	13	20	52	1	11,47
3012M-52-14	14	20	52	1	11,47
3012M-62-3	3	18	62	1	11,52
3012M-62-4	4	18	62	1	11,52
3012M-62-5	5	18	62	1	11,52
3012M-62-6	6	18	62	1	11,52
3012M-62-7	7	18	62	1	11,52
3012M-62-8	8	18.5	62	1	11,52
3012M-62-9	9	18.5	62	1	11,61
3012M-62-10	10	20	62	1	11,61
3012M-62-11	11	20	62	1	12,18
3012M-62-12	12	20	62	1	12,18
3012M-62-13	13	20	62	1	12,43
3012M-62-14	14	20	62	1	12,43
3012M-75-3	3	18	75	1	12,13
3012M-75-4	4	18	75	1	12,13
3012M-75-5	5	18	75	1	12,13
3012M-75-6	6	18	75	1	12,13
3012M-75-7	7	18	75	1	12,13
3012M-75-8	8	18.5	75	1	12,13
3012M-75-9	9	18.5	75	1	12,82
3012M-75-10	10	20	75	1	12,82
3012M-75-11	11	20	75	1	13,26
3012M-75-12	12	20	75	1	13,26
3012M-75-13	13	20	75	1	14,27
3012M-75-14	14	20	75	1	14,27



ESAGONO

**SERIE 8 PZ. CHIAVI A BUSSOLA
MASCHIO ESAGONALE**

Koken articolo	mm	L mm		Euro
RS3010M-38/8	3, 4, 5, 6, 7, 8, 10, 12	38	1	66,58
RS3010M-62/8	3, 4, 5, 6, 7, 8, 10, 12	62	1	71,17
RS3010M-100/8	3, 4, 5, 6, 7, 8, 10, 12	100	1	77,83
RS3010A-50/8	1/8", 5/32", 3/16", 7/32", 1/4", 5/16", 3/8", 1/2"	50	1	83,33

POLLICI

NEW

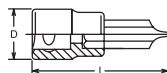

TAGLIO

**CHIAVI A BUSSOLA
A TAGLIO**

Koken articolo	mm	D mm	L mm		Euro
3005-60-5	1.0x5.5	18	60	1	11,25
3005-60-8	1.2x8	18	60	1	11,25
3005-60-10	1.6x10	20	60	1	12,76





POLLICI



ESAGONO

CHIAVI A BUSSOLA MASCHIO ESAGONALE INTEGRALI

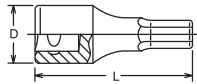

Koken articolo	pollici	D mm	L mm		Euro
3012A-52-1/8	1/8"	18	52	1	10,89
3012A-52-5/32	5/32"	18	52	1	10,89
3012A-52-3/16	3/16"	18	52	1	10,89
3012A-52-7/32	7/32"	18	52	1	10,89
3012A-52-1/4	1/4"	18	52	1	10,89
3012A-52-9/32	9/32"	18	52	1	11,00
3012A-52-5/16	5/16"	18.5	52	1	11,00
3012A-52-11/32	11/32"	18.5	52	1	11,69
3012A-52-3/8	3/8"	20	52	1	11,69
3012A-52-7/16	7/16"	20	52	1	12,07
3012A-52-1/2	1/2"	20	52	1	12,07
3012A-52-9/16	9/16"	20	52	1	12,07
3012A-62-1/8	1/8"	18	62	1	12,13
3012A-62-5/32	5/32"	18	62	1	12,13
3012A-62-3/16	3/16"	18	62	1	12,13
3012A-62-7/32	7/32"	18	62	1	12,13
3012A-62-1/4	1/4"	18	62	1	12,13
3012A-62-9/32	9/32"	18	62	1	12,13
3012A-62-5/16	5/16"	18.5	62	1	12,13
3012A-62-11/32	11/32"	18.5	62	1	12,16
3012A-62-3/8	3/8"	20	62	1	12,16
3012A-62-7/16	7/16"	20	62	1	12,76
3012A-62-1/2	1/2"	20	62	1	13,09
3012A-62-9/16	9/16"	20	62	1	13,09
3012A-75-1/8	1/8"	18	75	1	12,76
3012A-75-5/32	5/32"	18	75	1	12,76
3012A-75-3/16	3/16"	18	75	1	12,76
3012A-75-7/32	7/32"	18	75	1	12,76
3012A-75-1/4	1/4"	18	75	1	12,76
3012A-75-9/32	9/32"	18	75	1	12,76
3012A-75-5/16	5/16"	18.5	75	1	12,76
3012A-75-11/32	11/32"	18.5	75	1	13,45
3012A-75-3/8	3/8"	20	75	1	13,45
3012A-75-7/16	7/16"	20	75	1	13,89
3012A-75-1/2	1/2"	20	75	1	14,96
3012A-75-9/16	9/16"	20	75	1	14,96



ESAGONO

CHIAVI A BUSSOLA TESTA SFERICA MASCHIO MASCHIO ESAGONALE

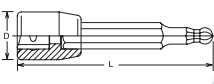

Koken articolo	mm	D mm	L mm		Euro
3011M-62-3	3	18	62	1	10,73
3011M-62-4	4	18	62	1	10,73
3011M-62-5	5	18	62	1	10,73
3011M-62-6	6	18	62	1	10,73
3011M-62-7	7	18	62	1	11,19
3011M-62-8	8	18	62	1	11,19
3011M-62-10	10	20	62	1	12,82
3011M-62-12	12	20	62	1	13,12
3011M-100-3	3	18	100	1	12,02
3011M-100-4	4	18	100	1	12,02
3011M-100-5	5	18	100	1	12,02
3011M-100-6	6	18	100	1	12,02
3011M-100-7	7	18	100	1	12,24
3011M-100-8	8	18	100	1	12,24
3011M-120-3	3	18	120	1	16,25
3011M-120-4	4	18	120	1	16,25
3011M-120-5	5	18	120	1	16,25
3011M-120-6	6	18	120	1	16,25
3011M-120-7	7	18	120	1	16,36
3011M-120-8	8	18	120	1	16,36
3011M-160-3	3	18	160	1	16,47
3011M-160-4	4	18	160	1	16,47
3011M-160-5	5	18	160	1	16,47
3011M-160-6	6	18	160	1	16,47
3011M-160-7	7	18	160	1	16,64
3011M-160-8	8	18	160	1	16,64



ESAGONO



CHIAVI A BUSSOLA MASCHIO ESAGONALE CON ANELLO DI TENUTA

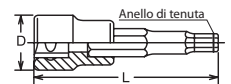

Koken articolo	mm	D mm	L mm		Euro
3015M-62-3	3	18	62	1	12,51
3015M-62-4	4	18	62	1	12,51
3015M-62-5	5	18	62	1	12,51
3015M-62-6	6	18	62	1	12,51
3015M-62-7	7	18	62	1	12,93
3015M-62-8	8	18	62	1	12,93
3015M-62-10	10	20	62	1	13,42
3015M-62-12	12	20	62	1	14,03
3015M-100-3	3	18	100	1	13,64
3015M-100-4	4	18	100	1	13,64
3015M-100-5	5	18	100	1	13,64
3015M-100-6	6	18	100	1	13,64
3015M-100-7	7	18	100	1	13,92
3015M-100-8	8	18	100	1	13,92
3015M-100-10	10	20	100	1	14,14
3015M-100-12	12	20	100	1	15,13



ESAGONO



CHIAVI A BUSSOLA A MANO SNODATE MASCHIO ESAGONALE

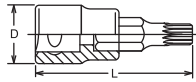

Koken articolo	mm	D ₁	L mm		Euro
3430M-5	5	19	62	1	24,78
3430M-6	6	19	62	1	24,78
3430M-7	7	19	62	1	24,78
3430M-8	8	19	62	1	24,78
3430M-10	10	19	62	1	24,78
3430M-12	12	19	62	1	24,78

KOKEN 3/8"

CHIAVI A BUSSOLA MASCHIO XZN

Koken articolo		D mm	L mm		Euro
3020-38-M 5	M 5	18	38	1	11,08
3020-38-M 6	M 6	18	38	1	11,08
3020-38-M 8	M 8	18	38	1	11,25
3020-38-M10	M10	20	38	1	11,85
3020-38-M12	M12	20	38	1	12,24
3020-38-M14	M14	22	38	1	13,75
3020-50-M 4	M 4	18	50	1	11,08
3020-50-M 5	M 5	18	50	1	11,08
3020-50-M 6	M 6	18	50	1	11,08
3020-50-M 8	M 8	18	50	1	11,25
3020-50-M10	M10	20	50	1	11,25
3020-50-M12	M12	20	50	1	12,24
3020-50-M14	M14	22	50	1	13,75
3020-100-M 4	M 4	18	100	1	12,13
3020-100-M 5	M 5	18	100	1	12,13
3020-100-M 6	M 6	18	100	1	12,13
3020-100-M 8	M 8	18	100	1	12,13
3020-100-M10	M10	20	100	1	13,20
3020-100-M12	M12	20	100	1	14,00
3020-100-M14	M14	22	100	1	15,51
3020-120-M 4	M 4	18	120	1	12,79
3020-120-M 5	M 5	18	120	1	12,79
3020-120-M 6	M 6	18	120	1	12,79
3020-120-M 8	M 8	18	120	1	12,79
3020-120-M10	M10	20	120	1	13,17
3020-120-M12	M12	20	120	1	14,47
3020-120-M14	M14	22	120	1	17,82

XZN



S

S





M	S mm	M	S mm
M 4	3,60	M12	11,50
M 5	4,80	M14	13,30
M 6	6,10	M16	15,70
M 8	7,30	M18	16,90
M10	9,70		

SERIE 6 PZ. CHIAVI A BUSSOLA MISURE: M5, M6, M8, M10, M12, M14

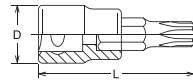
Koken articolo		L mm		Euro
RS3020/6-L38	M5, M6, M8, M10, M12, M14	38	1	68,72
RS3020/7-L50	M4, M5, M6, M8, M10, M12, M14	50	1	79,09

CHIAVI A BUSSOLA MASCHIO TORX®

Koken articolo		D mm	L mm		Euro
3025-38-T8	TX 8	18	38	1	10,53
3025-38-T9	TX 9	18	38	1	10,53
3025-38-T10	TX 10	18	38	1	10,53
3025-38-T15	TX 15	18	38	1	10,53
3025-38-T20	TX 20	18	38	1	10,53
3025-38-T25	TX 25	18	38	1	10,53
3025-38-T27	TX 27	18	38	1	10,53
3025-38-T30	TX 30	18	38	1	10,53
3025-38-T40	TX 40	18	38	1	11,85
3025-38-T45	TX 45	18	38	1	11,85
3025-38-T50	TX 50	20	38	1	11,85
3025-38-T55	TX 55	20	38	1	13,42
3025-50-T8	TX 8	18	50	1	10,53
3025-50-T9	TX 9	18	50	1	10,53
3025-50-T10	TX 10	18	50	1	10,53
3025-50-T15	TX 15	18	50	1	10,53
3025-50-T20	TX 20	18	50	1	10,53
3025-50-T25	TX 25	18	50	1	10,53
3025-50-T27	TX 27	18	50	1	10,53
3025-50-T30	TX 30	18	50	1	10,53
3025-50-T35	TX 35	18	50	1	12,13
3025-50-T40	TX 40	18	50	1	11,03
3025-50-T45	TX 45	18	50	1	11,03
3025-50-T50	TX 50	20	50	1	11,03
3025-50-T55	TX 55	20	50	1	13,42
3025-140-T9	TX 9	18	140	1	12,73
3025-140-T10	TX 10	18	140	1	12,73
3025-140-T15	TX 15	18	140	1	12,73
3025-140-T20	TX 20	18	140	1	12,73
3025-140-T25	TX 25	18	140	1	12,73
3025-140-T27	TX 27	18	140	1	12,73
3025-140-T30	TX 30	18	140	1	12,73
3025-140-T40	TX 40	18	140	1	12,90
3025-140-T45	TX 45	18	140	1	12,90
3025-140-T50	TX 50	20	140	1	13,61
3025-140-T55	TX 55	20	140	1	14,19

TORX®



S

S





T	S mm	T	S mm
T 6	1.70	T 40	6.70
T 7	2.00	T 45	7.90
T 8	2.30	T 50	8.90
T 9	2.50	T 55	11.30
T 10	2.70	T 60	13.30
T 15	3.30	T 70	15.60
T 20	3.90	T 80	17.60
T 25	4.50	T 90	20.00
T 27	5.00	T 100	22.20
T 30	5.60		

SERIE 8 PZ. CHIAVI A BUSSOLA MASCHIO TORX®

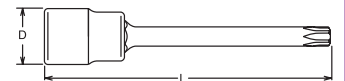
Koken articolo		L mm		Euro
RS3025/8-38	TX 10, 15, 20, 25, 27, 30, 40, 45	38	1	83,60
RS3025/8-50	TX 10, 15, 20, 25, 27, 30, 40, 45	50	1	82,86

CHIAVI A BUSSOLA MASCHIO TORX®



Koken articolo		D mm	L mm		Euro
3025-100R-T20	TX 20	18	100	1	13,26
3025-100R-T25	TX 25	18	100	1	13,26
3025-100R-T27	TX 27	18	100	1	13,26
3025-100R-T30	TX 30	18	100	1	13,26
3025-100R-T40	TX 40	18	100	1	14,74
3025-100R-T45	TX 45	18	100	1	14,74
3025-100R-T50	TX 50	20	100	1	15,18
3025-100R-T55	TX 55	20	100	1	16,58

Albero rotondo per facilitare l'accesso agli spazi stretti.





CHIAVI A BUSSOLA MASCHIO TORX® CON FORO



TORX® CON FORO

Koken articolo	♠	D mm	L mm		Euro
3025-50-T10H	TH 10	18	50	1	10,75
3025-50-T15H	TH 15	18	50	1	10,75
3025-50-T20H	TH 20	18	50	1	10,75
3025-50-T25H	TH 25	18	50	1	10,75
3025-50-T27H	TH 27	18	50	1	10,75
3025-50-T30H	TH 30	18	50	1	10,75
3025-50-T40H	TH 40	18	50	1	12,02
3025-50-T45H	TH 45	18	50	1	12,02
3025-50-T50H	TH 50	20	50	1	12,02
3025-50-T55H	TH 55	20	50	1	14,91
3025-160-T25H	TH 25	18	160	1	16,86
3025-160-T27H	TH 27	18	160	1	16,86
3025-160-T30H	TH 30	18	160	1	16,86
3025-160-T40H	TH 40	18	160	1	18,29
3025-160-T45H	TH 45	18	160	1	18,29
3025-160-T50H	TH 50	20	160	1	20,02
3025-160-T55H	TH 55	20	160	1	22,39

CHIAVI A BUSSOLA MASCHIO TORX® CON FORO



TORX® CON FORO

Koken articolo	♠	D mm	L mm		Euro
3025-100R-T20H	TH 20	18	100	1	14,27
3025-100R-T25H	TH 25	18	100	1	14,27
3025-100R-T27H	TH 27	18	100	1	14,27
3025-100R-T30H	TH 30	18	100	1	14,27
3025-100R-T40H	TH 40	18	100	1	15,98
3025-100R-T45H	TH 45	18	100	1	15,98
3025-100R-T50H	TH 50	20	100	1	16,67
3025-100R-T55H	TH 55	20	100	1	18,78

Albero rotondo per facilitare l'accesso agli spazi stretti.

CHIAVI A BUSSOLA MASCHIO PENTALOBATO CON FORO



PENTALOBATO CON FORO

Koken articolo	⬠	D mm	L mm		Euro
3025-50-10PR	10PR	18	50	1	14,69
3025-50-15PR	15PR	18	50	1	14,69
3025-50-20PR	20PR	18	50	1	14,69
3025-50-25PR	25PR	18	50	1	14,69
3025-50-27PR	27PR	18	50	1	14,69
3025-50-30PR	30PR	18	50	1	14,69
3025-50-40PR	40PR	18	50	1	16,42
3025-50-45PR	45PR	18	50	1	16,42
3025-50-50PR	50PR	20	50	1	16,42
3025-50-55PR	55PR	20	50	1	17,19

SERIE 4 PZ. CHIAVI A BUSSOLA MASCHIO TORX CON FORO L 160 PER SISTEMI ANTIMANOMISSIONE



Koken articolo	♠		Euro
3247	TH27, TH30, TH40, TH50	1	69,22

Per riparazioni Airbag



CHIAVI A BUSSOLA MASCHIO TORX PLUS®



TORXplus®

Koken articolo	♠	D mm	L mm		Euro
3025-50-10IP	10IP	18	50	1	13,01
3025-50-15IP	15IP	18	50	1	13,01
3025-50-20IP	20IP	18	50	1	13,01
3025-50-25IP	25IP	18	50	1	13,01
3025-50-27IP	27IP	18	50	1	13,01
3025-50-30IP	30IP	18	50	1	13,01
3025-50-40IP	40IP	18	50	1	14,58
3025-50-45IP	45IP	18	50	1	14,58
3025-50-50IP	50IP	20	50	1	14,58
3025-50-55IP	55IP	20	50	1	16,58

CHIAVI A BUSSOLA MASCHIO RIBE



RIBE

Koken articolo	⬠	D mm	L mm		Euro
3027-50-M5	M 5	18	50	1	14,38
3027-50-M6	M 6	18	50	1	14,47
3027-50-M7	M 7	18	50	1	14,96
3027-50-M8	M 8	18	50	1	14,96
3027-50-M9	M 9	20	50	1	16,97
3027-50-M10	M10	20	50	1	16,97
3027-50-M12	M12	20	50	1	18,81
3027-100-M5	M 5	18	100	1	15,51
3027-100-M6	M 6	18	100	1	15,51
3027-100-M8	M 8	18	100	1	16,56
3027-100-M10	M10	18	100	1	19,94
3027-100-M12	M12	18	100	1	21,70



TORXplus®	S mm	S mm	
8 IP	2.30	30 IP	5.60
9 IP	2.50	40 IP	6.70
10 IP	2.70	45 IP	7.90
15 IP	3.30	50 IP	8.90
20 IP	3.90	55 IP	11.30
25 IP	4.50	60 IP	13.30
27 IP	5.00		

RIBE	S mm	W mm
M 5	5.00	1.20
M 6	6.00	1.30
M 7	7.00	1.40
M 8	8.00	1.80
M 9	9.00	2.00
M 10	10.00	2.30
M 12	12.00	2.60
M 13	13.00	3.10
M 14	14.00	3.20
M 16	16.00	3.60

PENTALOBATA	S mm	S mm	
8 PR	2.20	27 PR	4.70
9 PR	2.40	30 PR	5.20
10 PR	2.60	40 PR	6.30
15 PR	3.10	45 PR	7.40
20 PR	3.60	50 PR	8.40
25 PR	4.10	55 PR	10.60



SERIE 5 PZ. CHIAVI A BUSSOLA RIBE
MISURE: M5, M6, M8, M10, M12,

Koken articolo		L mm		Euro
RS3027/5-L50	M5, M6, M8, M10, M12,	50	1	77,50



QUADRO

CHIAVI A BUSSOLA MASCHIO QUADRO

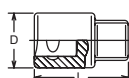

Koken articolo	mm	D mm	L mm		Euro
3110M-6	6	18	28	1	10,67
3110M-8	8	18	28	1	10,67
3110M-10	10	18	28	1	10,67
3110M-12	12	18	28	1	10,67

POLLICI



QUADRO

CHIAVI A BUSSOLA MASCHIO QUADRO

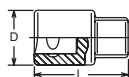

Koken articolo	mm	D mm	L mm		Euro
3110A-5/16	5/16	18	28	1	11,52
3110A-3/8	3/8	18	28	1	11,52
3110A-1/2	1/2	18	28	1	11,52



MECCANISMO
24
DENTI

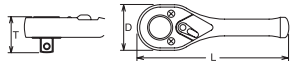

CRICCHETTO PORTABUSSOLA REVERSIBILE

Koken articolo	D mm	T mm	L mm		Euro
2749PS-3/8	25	21,9	75	1	55,22



CRICCHETTO PORTABUSSOLA REVERSIBILE

Koken articolo	D mm	T mm	L mm		Euro
2749P-3/8	25	21,9	125	1	56,71



MECCANISMO
24
DENTI

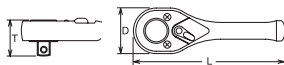

CRICCHETTO PORTABUSSOLA REVERSIBILE

Koken articolo	D mm	T mm	L mm		Euro
3749S	34	24,8	110	1	45,16



MECCANISMO
24
DENTI

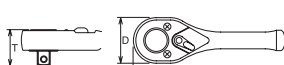

CRICCHETTO PORTABUSSOLA REVERSIBILE
CON PULSANTE DI SBLOCCAGGIO RAPIDO

Koken articolo	D mm	T mm	L mm		Euro
3749SB	34	24,8	110	1	56,18



MECCANISMO
24
DENTI



CRICCHETTO PORTABUSSOLA REVERSIBILE

Koken articolo	D mm	T mm	L mm		Euro
3752J	33	34,3	200	1	71,34



MECCANISMO
24
DENTI

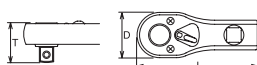

CRICCHETTO PORTABUSSOLA REVERSIBILE
MULTIFUNZIONE

Koken articolo	D mm	T mm	L mm		Euro
3753SM	30,5	26,4	81	1	69,27



MECCANISMO
24
DENTI

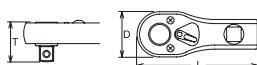

CRICCHETTO PORTABUSSOLA REVERSIBILE
MULTIFUNZIONE CON PULSANTE DI
SBLOCCAGGIO RAPIDO

Koken articolo	D mm	T mm	L mm		Euro
3753SMB	30,5	26,4	81	1	80,74



MECCANISMO
24
DENTI

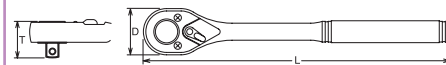

CRICCHETTO PORTABUSSOLA REVERSIBILE

Koken articolo	D mm	T mm	L mm		Euro
3753J	30,5	26,4	200	1	49,86



MECCANISMO
24
DENTI

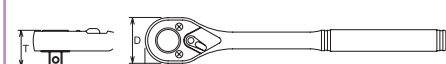

CRICCHETTO PORTABUSSOLA REVERSIBILE

Koken articolo	D mm	T mm	L mm		Euro
3753P	30,5	26,4	200	1	46,67
3753P-250	30,5	26,4	250	1	67,24



MECCANISMO
24
DENTI

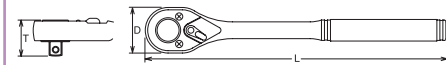

CRICCHETTO PORTABUSSOLA REVERSIBILE
CON PULSANTE DI SBLOCCAGGIO RAPIDO

Koken articolo	D mm	T mm	L mm		Euro
3753JB	30,5	26,4	200	1	61,33



MECCANISMO
24
DENTI

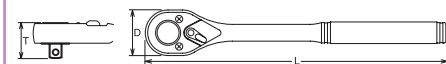

CRICCHETTO PORTABUSSOLA REVERSIBILE
CON PULSANTE DI SBLOCCAGGIO RAPIDO

Koken articolo	D mm	T mm	L mm		Euro
3753PB	30,5	26,4	200	1	58,55



MECCANISMO
24
DENTI

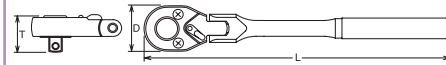

CRICCHETTO PORTABUSSOLA
REVERSIBILE SNODATO

Koken articolo	D mm	T mm	L mm		Euro
2774JS-3/8	25	21,9	120	1	75,30



MECCANISMO 24 DENTI



CRICCHETTO PORTABUSSOLA REVERSIBILE SNODATO

Koken articolo	D mm	T mm	L mm		Euro
3774PS-3/8	25	21,9	120	1	71,36



MECCANISMO 24 DENTI



CRICCHETTO PORTABUSSOLA REVERSIBILE SNODATO CON PULSANTE DI SBLOCCAGGIO RAPIDO

Koken articolo	D mm	T mm	L mm		Euro
3774PB	30,5	26,4	285	1	81,73



MECCANISMO 45 DENTI



CRICCHETTO PORTABUSSOLA REVERSIBILE CON TESTA GIREVOLE

Koken articolo	D mm	T mm	L mm		Euro
3776J	44	34,3	280	1	132,41



MECCANISMO 24 DENTI



CRICCHETTO PORTABUSSOLA REVERSIBILE SNODATO

Koken articolo	D mm	T mm	L mm		Euro
3774PS	30,5	26,4	175	1	75,87



MECCANISMO 24 DENTI



CRICCHETTO PORTABUSSOLA REVERSIBILE SNODATO CON PULSANTE DI BLOCCAGGIO TESTA

Koken articolo	D mm	T mm	L mm		Euro
3774JL	30,5	26,4	285	1	91,93



MECCANISMO 45 DENTI



CRICCHETTO PORTABUSSOLA REVERSIBILE CON TESTA GIREVOLE

Koken articolo	D mm	T mm	L mm		Euro
3776P	44	34,3	280	1	135,91



MECCANISMO 24 DENTI



CRICCHETTO PORTABUSSOLA REVERSIBILE SNODATO

Koken articolo	D mm	T mm	L mm		Euro
3774J	30,5	26,4	175	1	76,23



MECCANISMO 24 DENTI



CRICCHETTO PORTABUSSOLA REVERSIBILE SNODATO CON PULSANTE DI BLOCCAGGIO TESTA

Koken articolo	D mm	T mm	L mm		Euro
3774PL	30,5	26,4	265	1	96,69



MECCANISMO 45 DENTI



ADATTATORE A CRICCHETTO

Koken articolo	D mm	L mm		Euro
3755K	30,5	55	1	57,31



MECCANISMO 24 DENTI



CRICCHETTO PORTABUSSOLA REVERSIBILE SNODATO

Koken articolo	D mm	T mm	L mm		Euro
3774P	30,5	26,4	265	1	73,62



MECCANISMO 24 DENTI



CRICCHETTO PORTABUSSOLA REVERSIBILE SNODATO CON PULSANTE DI BLOCCAGGIO TESTA E PULSANTE DI SBLOCCAGGIO RAPIDO

Koken articolo	D mm	T mm	L mm		Euro
3774JBL	30,5	26,4	285	1	105,13



ADATTATORE DINAMOMETRICO

Koken articolo	Nm	L mm		Euro
3701-20Nm	20	75	1	90,23
3701-30Nm	30	75	1	91,80



MECCANISMO 24 DENTI



CRICCHETTO PORTABUSSOLA REVERSIBILE SNODATO CON PULSANTE DI SBLOCCAGGIO RAPIDO

Koken articolo	D mm	T mm	L mm		Euro
3774JB	30,5	26,4	285	1	84,15

KOKEN 3/8"

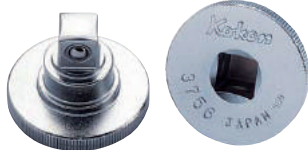
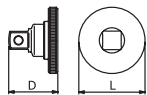
**ADATTATORE
A MANOPOLA
PORTABUSSOLA**

Koken articolo	D mm	L mm		Euro
3756	35	26	1	18,18

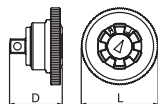

**ADATTATORE
A MANOPOLA
PORTABUSSOLA
CON CRICCHETTO
REVERSIBILE D/S**

Koken articolo	D mm	L mm		Euro
3757	50	35	1	54,97

**MECCANISMO
DENTI
45**
Cod. 3756 - 3757

- Ideale per lavorare in spazi ristretti.
- La zigrinatura dell'anello esterno aumenta la presa.
- Indicatori sulla testa per identificare direzione dx/sx

PROLUNGA

Koken articolo	D mm	L mm		Euro
3760-32	18	32	1	9,76
3760-50	18	50	1	9,76
3760-75	18	75	1	9,76
3760-125	18	125	1	10,34
3760-150	18	150	1	13,64
3760-250	18	250	1	16,47
3760-300	18	300	1	20,13
3760-400	18	400	1	26,13
3760-500	18	500	1	35,89
3760-600	18	600	1	35,89
3760-900	18	900	1	65,78
3760-1000	18	1000	1	87,04

FLEX

PROLUNGA FLESSIBILE

Koken articolo	D mm	L mm		Euro
3762	19,3	300	1	35,45

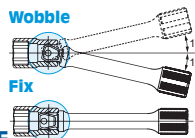

PROLUNGA CON TESTA SFERICA
**SISTEMA WOBBLE-FIX
CON DUE MODALITÀ DI
UTILIZZO:**

- PROLUNGA TESTA SFERICA ANGOLO 15°
- PROLUNGA TRADIZIONALE



Koken articolo	D mm	L mm		Euro
3763-32	18	32	1	10,29
3763-50	18	50	1	12,18
3763-75	18	75	1	12,57
3763-125	18	125	1	14,58
3763-150	18	150	1	18,45
3763-250	18	250	1	22,30
3763-300	18	300	1	24,97

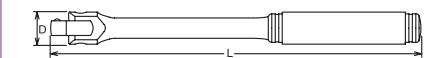

**QUADRO MASCHIO SNODATO CON
IMPUGNATURA**

Koken articolo	D mm	L mm		Euro
3768J-250	20,5	250	1	38,28

**QUADRO MASCHIO SNODATO CON
IMPUGNATURA IN METALLO**

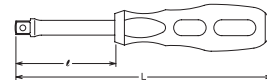
Koken articolo	D mm	L mm		Euro
3768P-250	20,5	250	1	38,03
3768P-380	20,5	380	1	48,35

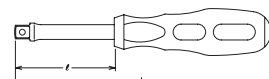

QUADRO MASCHIO CON IMPUGNATURA

Koken articolo	ℓ mm	L mm		Euro
3769N-160	50	160	1	15,32
3769N-230	120	230	1	18,04

**TESTA
SFERICA**

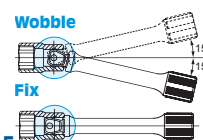
**QUADRO MASCHIO CON IMPUGNATURA
A TESTA SFERICA**
**SISTEMA WOBBLE-FIX
CON DUE MODALITÀ DI
UTILIZZO:**

- PROLUNGA TESTA SFERICA ANGOLO 15°
- PROLUNGA TRADIZIONALE



Koken articolo	ℓ mm	L mm		Euro
3769NWF-160	50	160	1	17,30
3769NWF-230	120	230	1	20,13

**QUADRO MASCHIO PIEGHEVOLE 90°
CON IMPUGNATURA**

Koken articolo	L mm		Euro
3769H	170	1	49,28

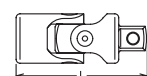
SNODO

Koken articolo	L mm		Euro
3770	50	1	20,96

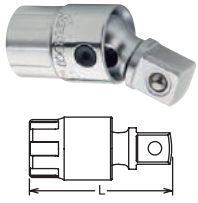

SNODO

Koken articolo	L mm		Euro
3771	43	1	26,95



QUADRO MASCHIO CON MANOVELLA

Koken articolo	H mm	L mm		Euro
3780	100	400	1	27,75

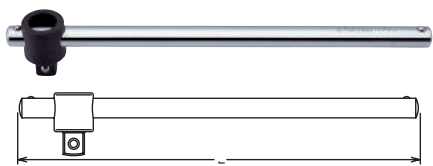

ASTA OVALE
L'innovativa barra a forma ovale offre una maggiore durata e impedisce al quadro scorrevole di ruotare attorno l'asta.



QUADRO MASCHIO CON ASTA SCORREVOLE

Koken articolo	L mm		Euro
3785	200	1	15,79

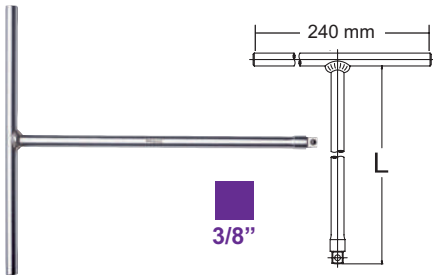

CHIAVI A "T" MASCHIO QUADRO 3/8" LARGHEZZA IMPUGNATURA 240 MM

Koken articolo	pollici	L mm		Euro
3715-3/8	3/8"	268	1	22,22

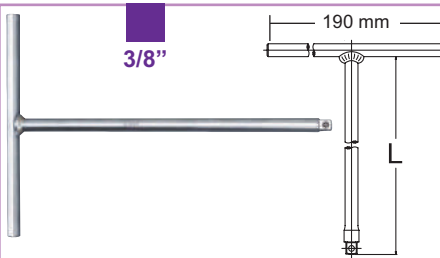

CHIAVI A "T" MASCHIO QUADRO 3/8" LARGHEZZA IMPUGNATURA 190 MM

Koken articolo	pollici	L mm		Euro
3715S-3/8	3/8"	268	1	22,22

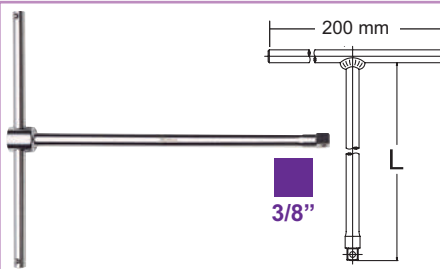

CHIAVI A "T" MASCHIO QUADRO 3/8" CON ASTA SCORREVOLE LARGHEZZA 200 MM

Koken articolo	pollici	L mm		Euro
3715SL-3/8	3/8"	237	1	31,76

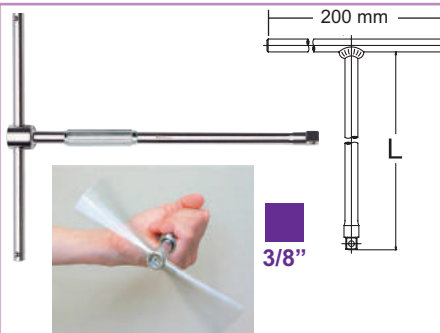

CHIAVI A "T" MASCHIO QUADRO 3/8" CON ASTA SCORREVOLE E CANOTTO DI ROTAZIONE LARGHEZZA 200 MM

Koken articolo	pollici	L mm		Euro
3715SLK-3/8	3/8"	236	1	64,54

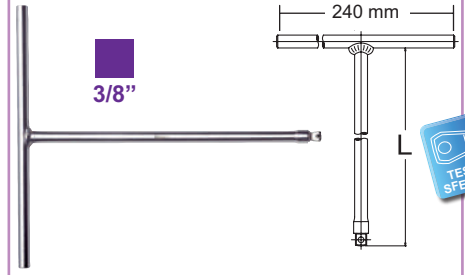

CHIAVI A "T" MASCHIO QUADRO 3/8" TESTA SFERICA CON IMPUGNATURA LARGHEZZA 240 MM

Koken articolo	pollici	L mm		Euro
3716-3/8	3/8"	268	1	30,20

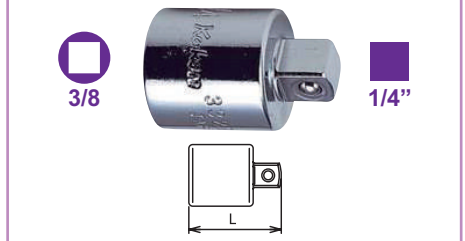

RACCORDO DI RIDUZIONE QUADRO MASCHIO 1/4" E FEMMINA 3/8"

Koken articolo	L mm		Euro
3322A	24	1	9,52

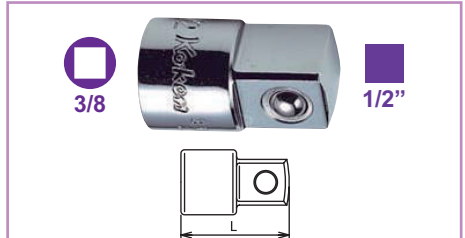

RACCORDO DI RIDUZIONE QUADRO MASCHIO 1/2" E FEMMINA 3/8"

Koken articolo	L mm		Euro
3344A	30	1	9,57





**SERIE 14 PZ. CHIAVI A BUSSOLA
BOCCA ESAGONALE / POLIGONALE
CASSETTA METALLICA 163 X 52 X H 33 MM**

Koken articolo	DESCRIZIONE		Euro
3217M-00	9, 10, 11, 12, 13, 14, 15, 16, 17, 18, 19, 20, 21, 22 MM	1	86,13
ESAGONO			
3217M-05	9, 10, 11, 12, 13, 14, 15, 16, 17, 18, 19, 20, 21, 22 MM	1	86,13
POLIGONALE			



Koken articolo	DESCRIZIONE	Euro
ESH3001	Cassetta metallica 17 Pz. 415 x 120 x h 50 mm	200,20
RICAMBI		
BUSSOLE		
SURFACE DRIVE	3410M	8, 9, 10, 11, 12, 13, 14, 15, 16, 17, 18, 19
ACCESSORI		
	3753J	
	3763-125	
	3760-250	
	3770	
	3785	



Koken articolo	DESCRIZIONE	Euro
3250M-00	Cassetta metallica 17 Pz. 415 x 120 x h 50 mm	188,95
RICAMBI		
BUSSOLE		
ESAGONO	3400M	7, 8, 10, 11, 12, 13, 14, 15, 16, 17, 18, 19
ACCESSORI		
	3753J	
	3763-125	
	3760-250	
	3770	
	3785	



Koken articolo	DESCRIZIONE	Euro
3250M-05	Cassetta metallica 17 Pz. 415 x 120 x h 50 mm	188,95
RICAMBI		
BUSSOLE		
POLIGONALE	3405M	7, 8, 10, 11, 12, 13, 14, 15, 16, 17, 18, 19
ACCESSORI		
	3753J	
	3763-125	
	3760-250	
	3770	
	3785	



Koken articolo	DESCRIZIONE	Euro
3210M-00	Cassetta metallica 22 Pz. 360 x 150 x h 50 mm	253,47
RICAMBI		
BUSSOLE		
ESAGONO	3400M	6, 7, 8, 9, 10, 11, 12, 13, 14, 15, 16, 17, 18, 19, 21, 22
ACCESSORI		
	3753J	
	3760-125	
	3760-250	
	3768J-250	
	3770	
	3785	



Koken articolo	DESCRIZIONE	Euro
3210M-05	Cassetta metallica 22 Pz. 360 x 150 x h 50 mm	253,47
RICAMBI		
BUSSOLE		
POLIGONALE	3405M	6, 7, 8, 9, 10, 11, 12, 13, 14, 15, 16, 17, 18, 19, 21, 22
ACCESSORI		
	3753J	
	3760-125	
	3760-250	
	3768J-250	
	3770	
	3785	



Koken articolo	DESCRIZIONE	Euro
ETH3001	Cassetta metallica 22 Pz. 310 x 86 x h 40 mm	203,94
RICAMBI		
BUSSOLE		
TORX	3425 3/8"	E4, E5, E6, E7, E8
	4425 1/2"	E10, E11, E12, E14, E16, E18
BUSSOLE		
TORX	3025.50 3/8"	T10, T15, T20, T25, T27
	4025.60 1/2"	T30, T40, T45, T50, T55
ACCESSORI	4433A-35	



Koken articolo	DESCRIZIONE	Euro
3210M-10	Cassetta metallica 22 Pz. 360 x 150 x h 50 mm	249,54
RICAMBI		
BUSSOLE		
SURFACE DRIVE	3410M	6, 7, 8, 9, 10, 11, 12, 13, 14, 15, 16, 17, 18, 19, 21, 22
ACCESSORI		
	3753J	
	3760-125	
	3760-250	
	3768J-250	
	3770	
	3785	

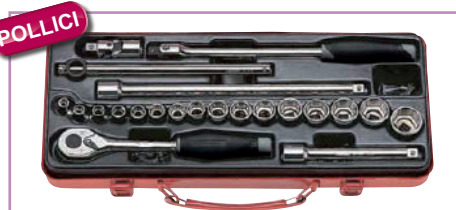

Koken articolo	DESCRIZIONE	Euro
3210A-00	Cassetta metallica 22 Pz. 360 x 150 x h 50 mm	233,75
RICAMBI		
BUSSOLE		
ESAGONO	3400A	1/4, 5/16, 11/32, 3/8, 7/16, 1/2, 9/16, 5/8, 11/16, 3/4, 13/16, 7/8
ACCESSORI		
	3753J	
	3760-125	
	3760-250	
	3768J-250	
	3770	
	3785	

POLLICI

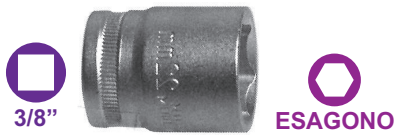

BUSSOLE CHROM-VANADIUM - SATINATE

Attacco: 3/8"
impronta: ESAGONO

BGS articolo	mm	L mm		Euro
3815-0060	6	28	1	2,63
3815-0070	7	28	1	2,63
3815-0080	8	28	1	2,63
3815-0090	9	28	1	2,63
BGS 10610	10	28	1	2,63
BGS 10611	11	28	1	2,63
BGS 10612	12	28	1	2,63
BGS 10613	13	28	1	2,63
BGS 10614	14	28	1	3,15
BGS 10615	15	28	1	3,15
BGS 10616	16	28	1	3,15
BGS 10617	17	28	1	3,15
BGS 10618	18	28	1	3,78
BGS 10619	19	28	1	3,99
3815-0200	20	28	1	4,62
3815-0210	21	28	1	4,62
3815-0220	22	28	1	5,46
3815-0240	24	28	1	6,59
BGS 10627 NEW	27	28	1	9,95



BUSSOLE CHROM-VANADIUM - SATINATE SURFACE DRIVE

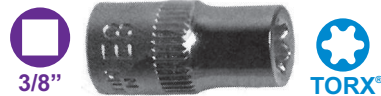

Attacco: 3/8"
impronta: SURFACE-DRIVE

BGS articolo	mm	L mm		Euro
BGS 2366	6	28	1	2,30
BGS 2367	7	28	1	2,30
BGS 2368	8	28	1	2,30
BGS 2369	9	28	1	2,30
BGS 2370	10	28	1	2,30
BGS 2371	11	28	1	2,30
BGS 2372	12	28	1	2,30
BGS 2373	13	28	1	2,30
BGS 2374	14	28	1	2,30
BGS 2375	15	28	1	2,30
BGS 2376	16	28	1	2,70
BGS 2377	17	28	1	2,70
BGS 2378	18	28	1	2,81
BGS 2379	19	28	1	2,88
BGS 2380	20	28	1	2,88
BGS 2381	21	28	1	3,44
BGS 2382	22	28	1	3,57
BGS 2384	24	28	1	3,83



BUSSOLE CHROM-VANADIUM - SATINATE

Attacco: 3/8"
impronta: TORX®

BGS articolo		L mm		Euro
BGS 2710	E 4	28	1	3,55
BGS 2711	E 5	28	1	3,55
BGS 2712	E 6	28	1	3,55
BGS 2713	E 7	28	1	3,55
BGS 2714	E 8	28	1	3,55
BGS 6410	E 10	28	1	3,42
BGS 6411	E 11	28	1	3,42
BGS 6412	E 12	28	1	3,68
BGS 6414	E 14	28	1	3,68
BGS 6416	E 16	28	1	4,06
BGS 6418	E 18	28	1	4,70
BGS 2715	E 20	28	1	4,06

TORX®	S mm	S mm	
E 4	3.70	E 16	14.60
E 5	4.60	E 18	16.50
E 6	5.60	E 20	18.30
E 7	6.10	E 22	20.10
E 8	7.40	E 24	22.00
E 10	9.30	E 26	23.70
E 11	9.90	E 28	25.50
E 12	11.00	E 30	27.30
E 14	12.80	E 32	29.00



BUSSOLE CHROM-VANADIUM MULTIMPRONTA "SPLINE DRIVE"

Attacco: 3/8"
impronta: SPLINE DRIVE

BGS articolo	mm	L mm		Euro
BGS 10310	10	25	1	2,93
BGS 10311	11	25	1	2,93
BGS 10312	12	25	1	2,93
BGS 10313	13	25	1	2,93
BGS 10314	14	25	1	3,57
BGS 10315	15	25	1	3,57
BGS 10316	16	25	1	3,70
BGS 10317	17	25	1	3,70
BGS 10318	18	25	1	3,70
BGS 10319	19	25	1	4,08



BGS articolo	DESCRIZIONE	Euro
BGS 9104	SET 12 PEZZI, BUSSOLE ESAGONALI 8-19 MM, ATT. 3/8"	20,40

- CARATTERISTICHE**
- misure: 8-9-10-11-12-13-14-15-16-17-18-19 mm
 - finitura cromata satinata
 - zigrinate
 - su guida metallica



BGS articolo	DESCRIZIONE	Euro
BGS 9110	SET 11 PEZZI, BUSSOLE ESAGONALI IN POLLICI 5/16" - 7/8", ATT. 3/8"	20,91

- CARATTERISTICHE**
- misure: 5/16" - 11/32" - 3/8" - 7/16" - 1/2" - 9/16" - 5/8" - 11/16" - 3/4" - 13/16" - 7/8"
 - finitura cromata satinata
 - zigrinate
 - su guida metallica



BGS articolo	DESCRIZIONE	Euro
BGS 9105	SET 12 PEZZI, BUSSOLE POLIGONALI 8-19 MM, ATT. 3/8"	20,40

- CARATTERISTICHE**
- misure: 8-9-10-11-12-13-14-15-16-17-18-19 mm
 - finitura cromata satinata
 - zigrinate
 - su guida metallica



POLLICI

NEW



BGS articolo	DESCRIZIONE	Euro
BGS 9112	SET 11 PEZZI, BUSSOLE POLIGONALI IN POLLICI 5/16" - 7/8", ATT. 3/8"	20,66

CARATTERISTICHE

- misure: 5/16" - 11/32" - 3/8" - 7/16" - 1/2" - 9/16" - 5/8" - 11/16" - 3/4" - 13/16" - 7/8"
- finitura cromata satinata
- zigrinate
- su guida metallica



NEW



BGS articolo	DESCRIZIONE	Euro
BGS 9548	SET 10 PEZZI, BUSSOLE TORX FEMMINA, E4 - E16, ATT. 1/4" E 3/8"	11,44

CARATTERISTICHE

- zigrinate
- su guida metallica
- finitura cromata satinata
- misure:
 - attacco 1/4": E4 - E5 - E6 - E7 - E8
 - attacco 3/8": E10 - E11 - E12 - E14 - E16

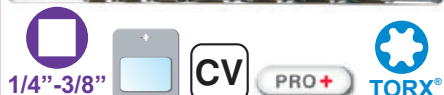

BGS articolo	DESCRIZIONE	Euro
BGS 2027	SET 7 PEZZI, BUSSOLE ATT. 1/4" + 3/8", TORX	13,26

CARATTERISTICHE

- attacco 1/4": E 6-7-8
- attacco 3/8": E 10-12-14-16
- finitura cromata satinata

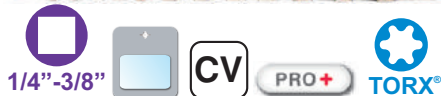

BGS articolo	DESCRIZIONE	Euro
BGS 2038	SET 12 PEZZI, BUSSOLE ATT. 1/4" + 3/8", TORX	21,17

CARATTERISTICHE

- finitura cromata satinata
- attacco 1/4": E 4-5-6-7-8
- attacco 3/8": E 10-11-12-14-16-18-20

TORX®

	S mm	S mm	
E 4	3.70	E 16	14.60
E 5	4.60	E 18	16.50
E 6	5.60	E 20	18.30
E 7	6.10	E 22	20.10
E 8	7.40	E 24	22.00
E 10	9.30	E 26	23.70
E 11	9.90	E 28	25.50
E 12	11.00	E 30	27.30
E 14	12.80	E 32	29.00



NEW



BGS articolo	DESCRIZIONE	Euro
BGS 9587	SET 7 PEZZI, BUSSOLE TORX PLUS ATT. 3/8", 10EPL - 20EPL	42,33

CARATTERISTICHE

- misure: 10 EPL - 11 EPL - 12 EPL - 14 EPL - 16 EPL - 18 EPL - 20 EPL
- su guida metallica

TORX PLUS®

	S mm	S mm	
E 4	3.70	E 16	14.60
E 5	4.60	E 18	16.50
E 6	5.60	E 20	18.30
E 7	6.10	E 22	20.10
E 8	7.40	E 24	22.00
E 10	9.30	E 26	23.70
E 11	9.90	E 28	25.50
E 12	11.00	E 30	27.30
E 14	12.80	E 32	29.00

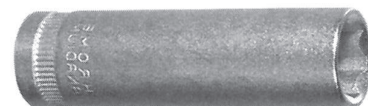

LUNGHE - ESAGONO INTERNO PROFONDO - SATINATE

Attacco: 3/8" impronta: ESAGONO

BGS articolo	mm	L mm		Euro
3820-0060	6	63	1	5,46
3820-0070	7	63	1	5,46
BGS 10528	8	63	1	5,46
3820-0090	9	63	1	5,46
BGS 10530	10	63	1	5,46
BGS 10531	11	63	1	5,46
BGS 10532	12	63	1	5,46
BGS 10533	13	63	1	5,46
BGS 10534	14	63	1	6,20
BGS 10535	15	63	1	6,20
BGS 10536	16	63	1	6,20
BGS 10537	17	63	1	6,20
BGS 10538	18	63	1	7,14
BGS 10539	19	63	1	7,14
3820-0200	20	63	1	7,14
3820-0210	21	63	1	8,40
3820-0220	22	63	1	8,40



BUSSOLE CHROM-VANADIUM - SATINATE LUNGHE - SURFACE DRIVE PROFONDITÀ IMPRONTA 28 MM

Attacco: 3/8" impronta: SURFACE-DRIVE

BGS articolo	mm	L mm		Euro
BGS 2610	8	63	1	4,00
BGS 2611	9	63	1	4,00
BGS 2600	10	63	1	4,00
BGS 2601	11	63	1	4,00
BGS 2602	12	63	1	4,00
BGS 2603	13	63	1	4,00
BGS 2604	14	63	1	4,00
BGS 2605	15	63	1	4,00
BGS 2606	16	63	1	4,00
BGS 2607	17	63	1	4,00
BGS 2608	18	63	1	4,50
BGS 2609	19	63	1	4,50

TORX® LUNGHE
Attacco: 3/8"
impronta: TORX®

articolo	Impronta	L mm	Imballaggio	Euro
3827-0555	E 5	55	1	13,19
3827-0655	E 6	55	1	13,19
3827-0755	E 7	55	1	13,19
3827-0863	E 8	63	1	13,19
3827-1063	E 10	63	1	13,19
3827-1163	E 11	63	1	13,19
3827-1263	E 12	63	1	13,19
3827-1463	E 14	63	1	13,19
3827-1663	E 16	63	1	13,82
3827-1863	E 18	63	1	13,82



ESAGONO
PRO+ CV
BUSSOLA ESAGONALE SNODATA CROMATA LUCIDATA

BGS articolo	mm	Imballaggio	Euro
BGS 2450	10	1	6,89
BGS 2452	12	1	6,89
BGS 2453	13	1	6,89
BGS 2454	14	1	6,89
BGS 2455	15	1	7,40
BGS 2456	16	1	7,40
BGS 2457	17	1	7,65
BGS 2458	18	1	7,65
BGS 2459	19	1	7,65

POLLICI



ESAGONO
PRO+ CV
SET 11 PEZZI, BUSSOLE ESAGONALI IN POLLICI LUNGHE

BGS articolo	DESCRIZIONE	Euro
BGS 2756	SET 11 PEZZI, BUSSOLE ESAGONALI IN POLLICI LUNGHE	38,25

CARATTERISTICHE

- esagonali
- 5/16", 11/32", 3/8", 7/16", 1/2", 9/16", 5/8", 11/16", 3/4", 13/16", 7/8"
- finitura satinata cromata



MULTIMPRONTA SPLINE DRIVE
BUSSOLE CHROM-VANADIUM MULTIMPRONTA "SPLINE DRIVE" - LUNGHE

mm Pollici Torx® XZN®

Attacco: 3/8"
impronta: SPLINE DRIVE

BGS articolo	mm	L mm	Imballaggio	Euro
BGS 10350	10	63	1	4,50
BGS 10351	11	63	1	4,50
BGS 10352	12	63	1	4,50
BGS 10353	13	63	1	4,50
BGS 10354	14	63	1	4,50
BGS 10355	15	63	1	4,50



ESAGONO
PRO+ CV
SET 10 PEZZI, BUSSOLE ESAGONALI SNODATE

BGS articolo	DESCRIZIONE	Euro
BGS 205	SET 10 PEZZI, BUSSOLE ESAGONALI SNODATE	70,64

CARATTERISTICHE

- finitura cromata lucida
- 10-11-12-13-14-15-16-17-18-19 mm



ESAGONO
PRO+ CV
SET 11 PEZZI, BUSSOLE ESAGONALI LUNGHE, 8-19 MM

BGS articolo	DESCRIZIONE	Euro
BGS 2222	SET 11 PEZZI, BUSSOLE ESAGONALI LUNGHE, 8-19 MM	36,72

CARATTERISTICHE

- finitura cromata satinata
- esagonali
- 8-10-11-12-13-14-15-16-17-18-19 mm

MILLIMETRI E POLLICI



BUSSOLA UNIVERSALE
PRO CV

BGS articolo	PER MISURE	Imballaggio	Euro
BGS 2533	3/8" 9-19 MM	1	16,58
BGS 2531	1/2" 11-30 MM	1	50,24

CARATTERISTICHE

- adatta a tutte le impronte esagonali anche in pollici

POLLICI **NEW**



ESAGONO
PRO+ CV
SET 7 PEZZI, BUSSOLE ESAGONALI IN POLLICI SNODATE 3/8" - 3/4", ATT. 3/8"

BGS articolo	DESCRIZIONE	Euro
BGS 9501	SET 7 PEZZI, BUSSOLE ESAGONALI IN POLLICI SNODATE 3/8" - 3/4", ATT. 3/8"	54,83

CARATTERISTICHE

- misure: 3/8" - 7/16" - 1/2" - 9/16" - 5/8" - 11/16" - 3/4"
- su guida metallica



POLIGONALE
PRO+ CV
SET 11 PEZZI, BUSSOLE TIPO LUNGO, POLIGONALI, ATT. 3/8"

BGS articolo	DESCRIZIONE	Euro
BGS 5252	SET 11 PEZZI, BUSSOLE TIPO LUNGO, POLIGONALI, ATT. 3/8"	36,47

CARATTERISTICHE

- misure: 8-10-11-12-13-14-15-16-17-18-19 mm
- finitura satinata cromata
- zigrinate
- su supporto in plastica

3/8"



3/8"

CHIAVI APERTE A ZAMPA DI GALLO

attacco: 3/8"

articolo	mm		Euro
BGS 1756-10	10	1	7,14
BGS 1756-11	11	1	7,40
BGS 1756-12	12	1	7,65
BGS 1756-13	13	1	7,91
BGS 1756-14	14	1	8,16
BGS 1756-15	15	1	8,42
BGS 1756-16	16	1	8,42
BGS 1756-17	17	1	8,42
BGS 1756-18	18	1	8,67
BGS 1756-19	19	1	8,67



3/8"



CHIAVI APERTE A ZAMPA DI GALLO

MISURE:

 10-11-12-13-14-15-16-17-18-19 MM
 SU GUIDA METALLICA

attacco: 3/8"

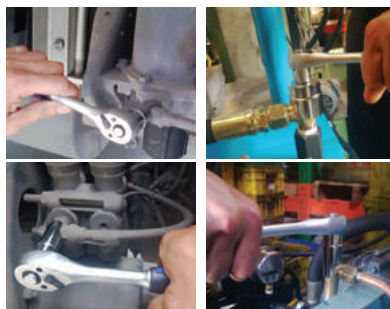
articolo	Descrizione		Euro
BGS 1756	SET 10 PEZZI CHIAVI APERTE	1	71,15

NEW

3/8"



articolo	DESCRIZIONE	Euro
BGS 9089	SET 5 PEZZI, BUSSOLE SPECIALI PER CONNETTORI A GOMITO	82,88

CARATTERISTICHE

- per allentare e serrare i connettori a gomito (connettori per tubi di tipo L)
- ad esempio per sospensioni ad aria di camion auto
- facilita il lavoro in spazi ristretti
- comprende 5 bussole aperte, delle misure: 12 - 14 - 17 - 19 - 22 mm



3/8"

PHILLIPS®

attacco: 3/8"

impronta: PHILLIPS®

articolo		L mm		Euro
BGS 2553	PH 1	48	1	3,06
BGS 2554	PH 2	48	1	3,06
BGS 2556	PH 3	48	1	3,06



3/8"

POZIDRIV®

attacco: 3/8"

impronta: POZIDRIV®

articolo		L mm		Euro
BGS 2550	PZ 1	48	1	3,06
BGS 2551	PZ 2	48	1	3,06



3/8"

TAGLIO

attacco: 3/8"

impronta: TAGLIO

articolo	mm	L mm		Euro
BGS 2568	7	48	1	3,06



3/8"

CHIAVI A BUSSOLA MASCHIO ESAGONALI

Attacco: 3/8"

impronta: ESAGONO

articolo	mm	L mm		Euro
BGS 2576	3	48	1	5,99
BGS 2577	4	48	1	5,99
BGS 2578	5	48	1	5,99
BGS 2579	6	48	1	5,99
BGS 2580	7	48	1	5,99
BGS 2581	8	48	1	5,99
BGS 2583	9	48	1	5,99
BGS 2582	10	48	1	5,99
BGS 2584	12	48	1	5,99



POLLICI



3/8"

ESAGONO

MISURE IN POLLICI

Attacco: 3/8"
impronta: ESAGONO

BGS articolo	mm	L mm		Euro
BGS 2720	1/8"	48	1	5,99
BGS 2721	5/32"	48	1	5,99
BGS 2722	3/16"	48	1	5,99
BGS 2723	7/32"	48	1	5,99
3855-0140	1/4"	48	1	5,99
BGS 2730	9/32"	48	1	5,99
BGS 2727	5/16"	48	1	5,99
BGS 2729	3/8"	48	1	5,99

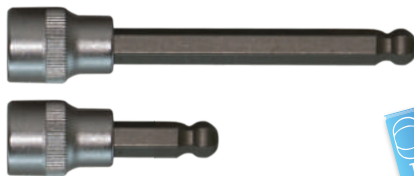

3/8"

ESAGONO

CHIAVI A BUSSOLA MASCHIO ESAGONALI TESTA SFERICA

Attacco: 3/8"
impronta: ESAGONO

BGS articolo	mm	L mm		Euro
BGS 5110	3	48	1	6,50
BGS 5111	4	48	1	6,50
BGS 5112	5	48	1	6,50
BGS 5113	5,5	48	1	6,50
BGS 5114	6	48	1	6,50
BGS 5115	10	48	1	6,50
3858-0310	3	100	1	8,79
3858-0410	4	100	1	8,79
3858-0510	5	100	1	8,79
3858-0610	6	100	1	8,79
3858-0710	7	100	1	8,79
3858-0810	8	100	1	8,79
3858-1010	10	100	1	8,79

3/8"



TORX®

CHIAVI A BUSSOLA MASCHIO TORX

Attacco: 3/8"
impronta: TORX®

BGS articolo		L mm		Euro
BGS 2760	TX 10	48	1	6,28
BGS 2541	TX 15	48	1	6,28
BGS 2542	TX 20	48	1	6,28
BGS 2543	TX 25	48	1	6,28
BGS 2544	TX 27	48	1	6,28
BGS 2545	TX 30	48	1	6,28
BGS 2546	TX 40	48	1	6,28
BGS 2547	TX 45	48	1	6,28
BGS 2548	TX 50	48	1	7,18
BGS 2549	TX 55	48	1	8,37
BGS 2761	TX 60	48	1	9,45
3868-4080	TX 40	80	1	8,37
3870-4514	TX 45	140	1	9,57

3/8"



TORX® CON FORO

CHIAVI A BUSSOLA MASCHIO TORX C/ FORO

Attacco: 3/8"
impronta: TORX® C/FORO

BGS articolo		L mm		Euro
3872-1050	TH 10	50	1	6,83
3872-1550	TH 15	50	1	6,83
BGS 2571	TH 20	50	1	6,83
BGS 2572	TH 25	50	1	6,83
BGS 2573	TH 27	50	1	6,83
BGS 2574	TH 30	50	1	6,83
BGS 2575	TH 40	50	1	7,35
BGS 2597	TH 45	50	1	7,35
3872-5050	TH 50	50	1	7,35
BGS 2599	TH 55	50	1	8,40

TORX®

	S mm	S mm	
T 6	1.70	T 40	6.70
T 7	2.00	T 45	7.90
T 8	2.30	T 50	8.90
T 9	2.50	T 55	11.30
T 10	2.70	T 60	13.30
T 15	3.30	T 70	15.60
T 20	3.90	T 80	17.60
T 25	4.50	T 90	20.00
T 27	5.00	T 100	22.20
T 30	5.60		

3/8"

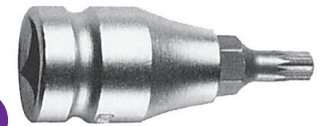

RIBE

CHIAVI A BUSSOLA MASCHIO RIBE

Attacco: 3/8"
impronta: RIBE

BGS articolo		L mm		Euro
3890-0550	M 5	50	1	4,73
3890-0650	M 6	50	1	4,73
3890-0850	M 8	50	1	4,73
3890-1050	M 10	50	1	4,73
BGS 4141	M 6	100	1	7,50
BGS 4142	M 7	100	1	7,50
BGS 4143	M 8	100	1	7,50
BGS 4145	M 10	100	1	7,50

RIBE

	S mm	W mm
M 5	5.00	1.20
M 6	6.00	1.30
M 7	7.00	1.40
M 8	8.00	1.80
M 9	9.00	2.00
M 10	10.00	2.30
M 12	12.00	2.60
M 13	13.00	3.10
M 14	14.00	3.20
M 16	16.00	3.60

3/8"



XZN

CHIAVI A BUSSOLA MASCHIO XZN

Attacco: 3/8"
impronta: XZN

BGS articolo		L mm		Euro
3880-0550	M 5	50	1	4,73
3880-0650	M 6	50	1	4,73
BGS 5105-M8	M 8	48	1	4,73
3880-1050	M 10	50	1	4,73
BGS 2587	M 12	48	1	4,73
3882-0890	M 8	90	1	7,88
3882-1090	M 10	90	1	7,88

XZN

	S mm	S mm	
M 4	3,60	M12	11,50
M 5	4,80	M14	13,30
M 6	6,10	M16	15,70
M 8	7,30	M18	16,90
M10	9,70		



BGS articolo	DESCRIZIONE	Euro
BGS 5109	SET 6 PEZZI, CHIAVI A BUSSOLA ESAGONO MASCHIO CON TESTA SFERICA, ATTACCO 3/8", 3-8 MM	18,62

CARATTERISTICHE

- con testa sferica
- 3 - 4 - 5 - 5.5 - 6 - 8 mm, lunghezza 50 mm
- in acciaio al cromo vanadio
- satinata
- zigrinate
- su guida



BGS articolo	DESCRIZIONE	Euro
BGS 5099	SET 10 PEZZI, CHIAVI A BUSSOLA ESAGONALI EXTRA CORTE, 4 - 19 MM	30,60

CARATTERISTICHE

- attacco 1/4", lunghezza 30 mm: 4 - 5 - 6 - 7 - 8 mm
- attacco 3/8", lunghezza 38 mm: 10 - 12 - 14 mm
- attacco 1/2", lunghezza 48 mm: 17 - 19 mm
- zigrinate
- finitura cromata satinata
- su guida metallica



BGS articolo	DESCRIZIONE	Euro
BGS 9341	SET 7 PEZZI, CHIAVI A BUSSOLA TORX CON FORO MASCHIO, TH15-TH50, ATT. 3/8"	19,13

CARATTERISTICHE

- misure: TH15-TH20-TH25-TH30-TH40-TH45-TH50
- lunghezza: 48 mm
- zigrinate
- finitura satinata cromata
- su guida metallica



BGS articolo	DESCRIZIONE	Euro
BGS 5107	SET 7 PEZZI, CHIAVI A BUSSOLA ESAGONO MASCHIO, ATTACCO 3/8"	17,21

CARATTERISTICHE

- misure: 3-4-5-6-7-8-10 mm
- su guida metallica



BGS articolo	DESCRIZIONE	Euro
BGS 5108	SET 7 PEZZI, BUSSOLE ATT. 3/8", TORX	17,72

CARATTERISTICHE

- Tx: 15- 20-25-30-40-45-50
- finitura cromata satinata
- su guida metallica



BGS articolo	DESCRIZIONE	Euro
BGS 5105	SET 8 PEZZI, BUSSOLE XZN	21,17

CARATTERISTICHE

- comprende:
 - attacco 1/4": M4-M5-M6
 - attacco 3/8": M8-10-12
 - attacco 1/2": M-14-16
- finitura cromata satinata
- su guida metallica

POLLICI

BGS articolo	DESCRIZIONE	Euro
BGS 5104	SET 7 PEZZI, CHIAVI A BUSSOLA ESAGONO MASCHIO IN POLLICI, ATTACCO 3/8"	17,21

CARATTERISTICHE

- finitura cromata satinata
- misure in pollici: 1/8", 5/32", 3/16", 7/32", 1/4", 5/16", 3/8"
- ideali per auto e moto inglesi ed americane
- su guida metallica



BGS articolo	DESCRIZIONE	Euro
BGS 5098	SET 12 PEZZI, CHIAVI A BUSSOLA TORX® EXTRA CORTE, T8 - T60	28,05

CARATTERISTICHE

- att. 1/4", lungh. 30 mm: T8-T10-T15-T20-T25-T27
- att. 3/8", lungh. 38 mm : T30-T40-T45-T50-T55
- attacco 1/2", lunghezza 48 mm: T60
- zigrinate
- finitura cromata satinata
- su guida metallica



BGS articolo	DESCRIZIONE	Euro
BGS 5185	SET 7 PEZZI, CHIAVI A BUSSOLA RIBE MASCHIO	33,02

CARATTERISTICHE

- attacco 3/8": M6, M7, M8, M10
- attacco 1/2": M12, M13, M14
- in acciaio al cromo vanadio
- satinata, zigrinate
- lunghezza: 75 mm
- su guida



NEW

Jeep **FIAT** **FCA**
FIAT CHRYSLER AUTOMOBILES

MORTORQ®

3/8"

FEIMEC articolo	DESCRIZIONE	Euro
TM-200601	SET 6 PEZZI, CHIAVI A BUSSOLA MORTORQ®, ATTACCO 3/8"	40,00

CARATTERISTICHE

- misure: MTS00 - MTS0 - MTS1 - MTS2 - MTS3 - MTS4
- lunghezza: 50 mm
- finitura cromata satinata
- in chrome vanadium
- su guida metallica
- per Jeep e FCA

3/8" 3/8"

PROLUNGHE
attacco: 3/8"

BGS articolo	L mm	Box	Euro
BGS 296	50	1	3,95
BGS 294	75	1	4,83
BGS 295	150	1	6,93
BGS 3132	610	1	26,01

3/8" 3/8"

PRO

BGS articolo	DESCRIZIONE	Euro
BGS 2236	SET 3 PEZZI PROLUNGHE	17,85

CARATTERISTICHE

- lunghezze: 375-450-600 mm
- acciaio al carbonio
- lucide

3/8" 3/8"

TESTA SFERICA

PROLUNGHE TESTA SFERICA

BGS articolo	L mm	Box	Euro
BGS 242	75	1	4,08
BGS 246	125	1	5,87
BGS 243	150	1	5,87
BGS 244	250	1	8,16
BGS 247	450	1	19,38

NEW

3/8" 3/8"

TESTA SFERICA

BGS articolo	DESCRIZIONE	Euro
BGS 6111	SET 5 PEZZI, PROLUNGHE TESTA SFERICA, ATT. 3/8"	33,28

CARATTERISTICHE

- comprende le seguenti misure:
- att. 3/8", lunghezza: 38, 75, 150, 250, 450 mm
- finitura cromata lucida
- in supporto in plastica

FEIMEC 3-PC, square Head Set

• CR-V Steel with chrome plated

• Size: 1/4" & 3/8" & 1/2"

1/4" 3/8" 1/2"

FEIMEC articolo	DESCRIZIONE	Euro
483814	SET 3 PEZZI, ADATTATORI DOPPIO QUADRO	12,60

CARATTERISTICHE

- comprende i seguenti adattatori con doppia sfera:
- 1/4" M - 1/4" F, lunghezza 20 mm, art. 2841
- 3/8" M - 3/8" F, lunghezza 30 mm, art. 3841
- 1/2" M - 1/2" F, lunghezza 37 mm, art. 4841

ADATTATORI DOPPIO QUADRO MASCHIO

FEIMEC articolo	L mm	Euro
2841	20	4,00
3841	30	5,00
4841	37	6,00
BGS 9623	53	9,69

CARATTERISTICHE

- con doppia sfera

NEW

1/4"-3/8"-1/2"

TESTA SFERICA

BGS articolo	DESCRIZIONE	Euro
BGS 6113	SET 9 PEZZI, PROLUNGHE TESTA SFERICA	40,04

CARATTERISTICHE

- comprende le seguenti misure:
- att. 1/4", lunghezza: 50, 100, 225 mm;
- att. 3/8", lunghezza: 75, 150, 225 mm;
- att. 1/2", lunghezza: 50, 125, 250 mm.
- finitura cromata lucida
- in supporto in plastica

TESTA SFERICA

1/4"-3/8"-1/2" **PRO+**

BGS articolo	DESCRIZIONE	Euro
BGS 2253	SET 9 PEZZI, PROLUNGHE TESTA SFERICA	55,97

CARATTERISTICHE

- comprende le seguenti misure:
- att. 1/4", lunghezza: 50 mm, 100 mm, 250 mm;
- att. 3/8", lunghezza: 75 mm, 150 mm, 250 mm;
- att. 1/2", lunghezza: 50 mm, 125 mm, 250 mm.

RICAMBI

BGS articolo	L mm	Euro
BGS 2232	50	3,57
BGS 2231	100	3,83
BGS 2219	250	6,63
BGS 242	75	4,08
BGS 243	150	5,87
BGS 244	250	8,16
BGS 233	50	6,30
BGS 234	125	9,45
BGS 235	250	15,75

TESTA SFERICA

3/8" PRO+ CV 3/8"

BGS articolo	DESCRIZIONE	Euro
BGS 2239	SET 3 PEZZI, PROLUNGHE	20,27

- CARATTERISTICHE**
- lunghezze: 75-150-250 mm
 - testa sferica
 - finitura cromata satinata
 - zigrinate

FLEX

FEMMINA MASCHIO

PROLUNGA FLESSIBILE MASCHIO - FEMMINA PER BUSSOLE

BGS articolo	MASCHIO	FEMMINA	L mm	Euro
3762	3/8"	3/8"	300	35,45

1/4"-3/8"-1/2" 1/4"-3/8"-1/2"

PRO+ CV

BGS articolo	DESCRIZIONE	Euro
BGS 198	SET 3 PEZZI, PROLUNGHE MAGNETICHE	17,72

- CARATTERISTICHE**
- per trattenerne viti e bulloni nella bussola

3/8" PRO+ CV

BGS articolo	DESCRIZIONE	Euro
BGS 288	ADATTATORE SCORREVOLE PER BARRE ATT. 3/8"	4,34

CARATTERISTICHE

- cromata, satinata
- per impiego con prolunghe

3/8" PRO+ 3/8"

BGS articolo	DESCRIZIONE	Euro
BGS 8617	PROLUNGA SPECIALE ATT. 3/8", 265 MM	95,63

- CARATTERISTICHE**
- particolarmente indicate per viti in posizione di difficile accesso
 - consente la trasmissione eccentrica
 - utile, ad esempio per le viti sulle coperture anteriori di motori trasversali e altre applicazioni
 - permette uno spostamento di 265 mm
 - coppia massima: 150 Nm
 - dimensioni: 44 x 320 mm

3/8" 3/8"

SNODO

attacco: 3/8"

BGS articolo	L mm	Euro
BGS 299	55	6,80

1/4"-3/8"-1/2" 1/4"-3/8"-1/2"

PRO+ CV

BGS articolo	DESCRIZIONE	Euro
BGS 252	SET 3 PEZZI SNODO CON MOLLA	26,01

CARATTERISTICHE

- cromati

3/8" 3/8"

ASTA CON QUADRO MASCHIO 3/8" SCORREVOLE

attacco: 3/8"

BGS articolo	L mm	Euro
BGS 277	200	10,00

3/8"

IMPUGNATURE PORTA BUSSOLE

Kokon articolo	L mm	Euro
3769 N-160	3/8" 160	15,32
3769 N-230	3/8" 230	18,04

3/8"

IMPUGNATURE A TESTA SFERICA PORTA BUSSOLE

SISTEMA WOBBLE-FIX CON DUE MODALITÀ DI UTILIZZO:

- PROLUNGA TESTA SFERICA ANGOLO 15°
- PROLUNGA TRADIZIONALE

attacco: 3/8"

Kokon articolo	L mm	Euro
3769 NWF-160	3/8" 160	17,30
3769 NWF-230	3/8" 230	20,13

3/8" PRO+ CV

BGS articolo	DESCRIZIONE	Euro
BGS 7802	IMPUGNATURA A T, CON QUADRO MASCHIO DA 3/8" LUNGHEZZA 230 MM	12,24

CARATTERISTICHE

- impugnatura ergonomica
- finitura satinata



TESTA SFERICA

3/8" PRO+ CV

BGS articolo	DESCRIZIONE	Euro
BGS 7802-1	IMPUGNATURA A T, CON QUADRO MASCHIO DA 3/8", LUNGHEZZA 230 MM, TESTA SFERICA	14,54

CARATTERISTICHE

- impugnatura ergonomica
- finitura satinata



3/8"

NUOVO CRICCHETTO REVERSIBILI A 72 DENTI CON PULSANTE DI SBLOCCAGGIO DELLA BUSSOLA ED IMPUGNATURA ERGONOMICA BICOMPONENTE ANTISCIVOLO E FORMA OVALE

BGS articolo	L mm	€
672	3/8" 190	31,50
576787	SET 3 PEZZI 1/4" - 3/8" - 1/2"	94,50



MECCANISMO 72 DENTI

3/8" PRO+ CV

BGS articolo	DESCRIZIONE	Euro
BGS 316	CRICCHETTO REVERSIBILE 3/8"	29,33

CARATTERISTICHE

- con pulsante di sgancio rapido
- impugnatura antiscivolo ergonomica in materiale bi-componente
- lunghezza 205 mm



3/8"

CHIAVE A "T" QUADRO MASCHIO SNODATA CROMATA ASTA SCORREVOLE CHROM-VANADIUM

BGS articolo	L mm	€
581-3/8"	3/8" 500	18,90



3/8" PRO+ CV

BGS articolo	DESCRIZIONE	Euro
BGS 2205	CHIAVE A CRICCHETTO REVERSIBILE 3/8"	27,92

CARATTERISTICHE

- impugnatura in ABS
- con pulsante di sgancio rapido
- lunghezza 210 mm



NEW

MECCANISMO 72 DENTI

3/8" CV

BGS articolo	DESCRIZIONE	Euro
BGS 518	CRICCHETTO REVERSIBILE, 72 DENTI, ATTACCO 3/8"	18,20



CRICCHETTO REVERSIBILE CON QUADRO FEMMINA PASSANTE

BGS articolo	L mm	Euro
BGS 9160	1/4" 115	23,14
3940	3/8" 260	28,00
BGS 312	1/2" 270	38,00
5840	3/4" 450	60,00
BGS 9622	3/4" 500	123,68
6040	10 mm 250	30,00
6340	13 mm 250	38,00
6540	15 mm 250	38,00
6640	16 mm 250	38,00

CARATTERISTICHE

- quadro passante
- impugnatura rivestita



3/8" PRO+ CV

BGS articolo	DESCRIZIONE	Euro
BGS 2308	CRICCHETTO REVERSIBILE 3/8"	29,75

CARATTERISTICHE

- con pulsante di sgancio rapido
- impugnatura in gomma a in materiale bi-componente
- lunghezza 260 mm



MECCANISMO 72 DENTI

3/8" PRO+ CV

BGS articolo	DESCRIZIONE	Euro
BGS 319	CRICCHETTO REVERSIBILE 3/8"	30,35

CARATTERISTICHE

- con pulsante di sgancio rapido
- stelo sfasato
- impugnatura antiscivolo ergonomica in materiale bi-componente
- lunghezza 205 mm

NEW **MECCANISMO 72 DENTI**





3/8" **PRO+**

BGS articolo	DESCRIZIONE	Euro
BGS 9090	CHIAVE A CRICCHETTO REVERSIBILE DA 3/8", 254 MM	38,00

CARATTERISTICHE

- 72 denti
- lunghezza: 254 mm
- impugnatura ergonomica antiscivolo in materiale bi-componente

NEW

3/8" **CV** **PRO+**

BGS articolo	DESCRIZIONE	Euro
BGS 601	CRICCHETTO REVERSIBILE, MODELLO CURVO, ATTACCO 3/8"	21,68
BGS 611	CRICCHETTO REVERSIBILE, "EXTRA SLIM", ATTACCO 3/8"	38,00

CARATTERISTICHE

- cricchetto reversibile 72 denti
- modello dritto "extra slim"
- con pulsante di sgancio rapido
- acciaio al Cromo Vanadio
- lunghezza: 195 mm
- peso: 220 grammi
- impugnatura in materiale bi-componente

NEW





BGS 601-REPAIR



3/8" **CV** **PRO+**

BGS articolo	DESCRIZIONE	Euro
BGS 601	CRICCHETTO REVERSIBILE, MODELLO CURVO, ATTACCO 3/8"	21,68

CARATTERISTICHE

- cricchetto reversibile 90 denti
- modello curvo
- con pulsante di sgancio rapido
- acciaio al Cromo Vanadio
- lunghezza: 205 mm
- peso: 140 grammi
- impugnatura in materiale bi-componente

RICAMBI

BGS articolo	DESCRIZIONE	Euro
BGS 601-REPAIR	SET RIPARAZIONE CRICCHETTO	8,42

NEW **MECCANISMO 72 DENTI**



3/8" **PRO+**

BGS articolo	DESCRIZIONE	Euro
BGS 303	CHIAVE A CRICCHETTO IN NYLON E FIBRA DI VETRO 3/8"	23,46

CARATTERISTICHE

- comodo utilizzo grazie ai materiali ultra-leggeri, nessun affaticamento
- i test su questo attrezzo hanno ottenuto risultati per capacità massima decisamente superiori ai limiti DIN
- lunghezza: circa 205 mm
- in polipropilene rivestito in acciaio CR-V con impugnatura in materiale bi-componente

NEW **MECCANISMO 72 DENTI**



3/8" **PRO+** **CV**

BGS articolo	DESCRIZIONE	Euro
BGS 209	CRICCHETTO "COMPATTO" 3/8"	27,80

CARATTERISTICHE

- extra-piccolo
- lunghezza 140 mm
- per spazi ristretti e angusti
- 72 denti
- con pulsante di sgancio rapido



3/8" **CV**

BGS articolo	DESCRIZIONE	Euro
BGS 301	CRICCHETTO "KRAFTMANN" 3/8"	9,36

CARATTERISTICHE

- reversibile
- con impugnatura ergonomica in gomma
- lunghezza 200 mm

QUANDO MANCA LO SPAZIO



3/8"

RUOTANDO L'IMPUGNATURA SI OTTIENE LA ROTAZIONE DEL QUADRO DX/SX

CRICCHETTO DOPPIA FUNZIONE:

- AZIONE A "CRICCO TRADIZIONALE"
- IMPUGNATURA ROTATIVA
- QUADRO MASCHIO SCORREVOLE

FERMEC articolo	L mm	1	Euro
952	3/8"	240	42,00



BGS 356-REPAIR

MECCANISMO 60 DENTI

3/8" PRO+ CV

BGS articolo	DESCRIZIONE	Euro
BGS 356	CHIAVE A CRICCHETTO ADATTA PER ESSERE USATA CON UNA SOLA MANO 3/8"	42,08

- CARATTERISTICHE**
- interruttore destro e sinistro si trovano nell'impugnatura della chiave, cosicché è possibile cambiare direzione usando la stessa mano che tiene la chiave
 - testa cricchetto extra-piatta
 - 60 denti
 - angolo di rotazione ridotto
 - finitura ad alta resistenza
 - lunghezza 200 mm

RICAMBI

BGS articolo	DESCRIZIONE	Euro
NEW BGS 356-REPAIR	KIT DI RIPARAZIONE	19,13

TESTA SNODATA

MECCANISMO 72 DENTI

3/8" PRO+ CV

BGS articolo	DESCRIZIONE	Euro
BGS 113	CHIAVE A CRICCHETTO CON TESTA SNODATA, REGOLABILE, 3/8"	45,77

- CARATTERISTICHE**
- testa snodata 180°
 - finitura cromata
 - cricchetto reversibile 72 denti
 - con pulsante di sgancio rapido
 - lunghezza 230 mm

TESTA SNODATA + ESTENSIBILE

MECCANISMO 72 DENTI

3/8" PRO+ CV

BGS articolo	DESCRIZIONE	Euro
BGS 25106	CRICCHETTO REVERSIBILE ESTENSIBILE SNODATO, 240-340 MM, ATTACCO 3/8"	47,18

- CARATTERISTICHE**
- regolabile in 4 posizioni da 240 a 340 mm
 - testa snodata regolabile in 10 posizioni
 - cricchetto 72 denti
 - con pulsante di sgancio rapido
 - acciaio al cromo vanadio, satinato

MECCANISMO 45 DENTI

3/8" PRO+ CV

BGS articolo	DESCRIZIONE	Euro
BGS 286	CHIAVE A CRICCHETTO CON TESTA SNODATA, REGOLABILE 3/8"	49,88

- CARATTERISTICHE**
- finitura satinata cromata
 - testa snodata regolabile in 5 posizioni
 - 45 denti
 - con pulsante di sgancio rapido
 - impugnatura con occhiello
 - lunghezza 270 mm

MECCANISMO 72 DENTI

1/4"-3/8"-1/2"

PRO+ CV

BGS articolo	DESCRIZIONE	Euro
BGS 215	SET 3 PEZZI, CRICCHETTI REVERSIBILI COMPATTI	95,63

CARATTERISTICHE

- formato extra-small per spazi ridotti e angusti
- 72 denti
- lunghezza cricchetti:
 - attacco 1/4": 110 mm
 - attacco 3/8": 140 mm
 - attacco 1/2": 170 mm





MECCANISMO
45
DENTI



BGS articolo	DESCRIZIONE	Euro
BGS 15112	SET 7 PEZZI, BUSSOLE DA 3/8"	31,20

CARATTERISTICHE

- chiave a cricchetto, reversibile con pulsante di sgancio rapido
- bussole da 8 - 10 - 13 - 15 - 17 e 19 mm

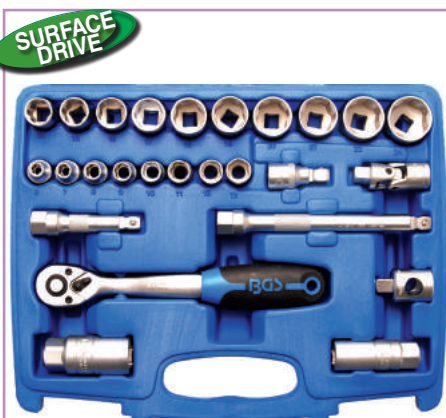

SURFACE DRIVE



BGS articolo	DESCRIZIONE	Euro
BGS 2227	SET 26 PEZZI, BUSSOLE	96,77

CARATTERISTICHE

- durezza e coppia in conformità con le norme DIN
- bussole "surface drive"
- 18 bussole: 6-7-8-9-10-11-12-13-14-15-16-17-18-19-20-21-22-24 mm
- bussole zigrinate, finitura satinata cromata
- 3 barre di prolunga 45-75-150 mm c/esagono
- 2 bussole per candele 16+21 mm
- 1 snodo
- chiave a cricchetto reversibile con pulsante di sgancio rapido
- adattatore 3/8" M - 1/2" F

RICAMBI

BGS articolo	DESCRIZIONE	Euro
BGS 2227-LEER	CASSETTA VUOTA	17,72



SURFACE DRIVE



BGS articolo	DESCRIZIONE	Euro
BGS 2229	SET 61 PEZZI, DI BUSSOLE	154,88

CARATTERISTICHE

- durezza e coppia in conformità con DIN
- chiavi a bussola: TX15-20-25-27-30-40-45-50-55
- PH 1-3
- PZ 1-3
- Taglio 5,5 - 7-8 mm
- Esagono 3-7, 8, 10 mm
- 18 bussole "Surface drive", 6-24 mm
- 10 bussole lunghe "Surface drive" 8-19 mm
- 2 bussole per candele 21 e 16 mm
- 1 snodo da 3/8" con molla
- 1 barra scorrevole a T/barra su prolunga 250 mm
- 1 barra di prolunga c/testa sferica 75 mm
- 1 chiave a cricchetto reversibile a 72 denti
- 1 adattatore da attacco quadro 3/8" x 8 mm esagonale

RICAMBI

BGS articolo	DESCRIZIONE	Euro
BGS 2229-LEER	CASSETTA VUOTA	18,62



POLLICI



BGS articolo	DESCRIZIONE	Euro
BGS 2215	SET 61 PEZZI, BUSSOLE IN POLLICI	156,25

CARATTERISTICHE

- durezza e coppia in conformità con DIN
- chiavi a bussola: TX15-20-25-27-30-40-45-50-55
- PH 1-3,
- PZ 1-3
- inserti Taglio 7/32"-15/16"
- inserti esagonali 1/8"-3/8"
- 18 bussole esagonali 1/4"-15/16"
- 10 bussole lunghe esagonali 5/16"-3/4"
- 2 bussole per candele 5/8" + 13/16"
- 1 snodo da 3/8" con molla
- 1 barra scorrevole a T/barra di prolunga 250 mm
- 1 barra di prolunga c/testa sferica 75 mm
- 1 chiave a cricchetto reversibile a 72 denti
- 1 adattatore da attacco quadro 3/8" x 8 mm esagonale





BGS articolo	DESCRIZIONE	Euro
BGS 2218	CASSETTA 61 PEZZI, UTENSILI ATTACCO 3/8"	156,75

CARATTERISTICHE

- comprende i seguenti utensili attacco quadro 3/8":
 - cricchetto reversibile, 72 denti
 - prolunga, 75 mm
 - chiave a T con quadro scorrevole
 - snodo
 - adattatore esagonale 8 mm
 - bussole per candele 16 e 21 mm
 - 18 bussole esagonali: 6-8-9-10-11-12-13-14-15-17-19-20-21-22-24 mm
 - 10 bussole esagonali lunghe: 8-9-10-11-12-13-14-15-17-19 mm
 - 25 bussole maschio:
 - taglio: 5.5 - 7 - 8 mm
 - PH: 1 - 2 - 3
 - PZ: 1 - 2 - 3
 - esagonali: 3-4-5-6-7-8-10 mm
 - Torx: Tx15 - Tx20 - Tx27 - Tx25 - Tx30 - Tx40 - Tx45 - Tx50 - Tx55



BGS articolo	DESCRIZIONE	Euro
BGS 2289	SET 92 PEZZI, BUSSOLE E ACCESSORI ATTACCO 1/4" E 3/8"	224,88

CARATTERISTICHE

- comprende i seguenti utensili attacco 1/4":
 - cricchetto reversibile 72 denti
 - bussole esagonali: 4 - 4.5 - 5 - 6 - 7 - 8 - 9 - 10 - 11 - 13 mm
 - bussole esagonali lunghe: 6 - 8 - 10 - 11 - 13 mm
 - 1 adattatore portainseriti
 - 1 impugnatura 150 mm
 - 1 snodo
 - 1 prolunga
 - 1 leva con quadro scorrevole
- comprende i seguenti utensili attacco 3/8":
 - cricchetto reversibile 72 denti
 - bussole esagonali: 14 - 15 - 16 - 17 - 19 - 20 - 21 - 22 - 23 - 24 mm
 - bussole esagonali lunghe: 14 - 16 - 17 - 19 mm
 - 1 adattatore portainseriti
 - 1 snodo
 - 1 prolunga
 - 3 bussole per candele: 16 - 18 - 21 mm
 - 1 riduzione quadro 3/8" Femmina - quadro 1/4" Maschio
- 29 inserti (S2):
 - Taglio: 2 - 2.5 - 3 - 4 - 5 - 6 - 7 mm
 - PH: PH0, PH1, PH2, PH3
 - PZ: PZ0, PZ1, PZ2, PZ3
 - Esagonali: 1.5 - 2 - 2.5 - 3 - 4 - 5 - 7 mm
 - Torx: TX10 - TX15 - TX20 - TX25 - TX27 - TX30 - TX40
- 9 chiavi combinate: 6 - 8 - 10 - 11 - 13 - 14 - 16 - 17 - 19 mm
- 9 chiavi a L esagonali: 1.5 - 2 - 2.5 - 3 - 4 - 5 - 6 - 8 - 10 mm



Ideale per AUTO & MOTO inglesi e americane



BGS articolo	DESCRIZIONE	Euro
BGS 2299	SET 92 PEZZI, BUSSOLE IN POLLICI	249,88

CARATTERISTICHE

- con bussole esagonali
- 2 chiavi a cricchetto a 72 denti 1/4" + 3/8"
- bussole corte, attacco 1/4": 5/32", 3/16", 7/32", 1/4", 9/32", 5/16", 11/32", 3/8", 7/16", 1/2"
- bussole lunghe, attacco 1/4": 1/4", 5/16", 3/8", 7/16", 1/2"
- adattatore inserto 1/4"
- 1 impugnatura con quadro 1/4" (6.3)
- 1 snodo 1/4"
- 1 barra di prolunga con esagono esterno, 1/4"
- 1 impugnatura scorrevole a T con adattatore 1/4"
- bussole corte, attacco da 3/8": 1/2", 9/16", 19/32", 5/8", 11/16", 3/4", 25/32", 13/16", 7/8", 15/16", 1"
- bussole lunghe, attacco da 3/8": 9/16", 5/8", 11/16", 3/4"
- adattatore inserto da 3/8"
- 1 snodo da 3/8"
- 1 barra di prolunga da 3/8"
- 3 bussole per candele: 5/8", 3/4", 13/16"
- assortimento di 29 pz. con Taglio, PH, PZ, Esagono, Torx
- set chiavi combinate da 9 pz.: 1/4", 5/16", 3/8", 7/16", 1/2", 9/16", 5/8", 11/16", 3/4"
- chiavi a Esagono: 1/16", 5/64", 3/32", 1/8", 5/32", 3/16", 1/4", 5/16", 3/8"
- 1 adattatore 1/4" M - 3/8" F

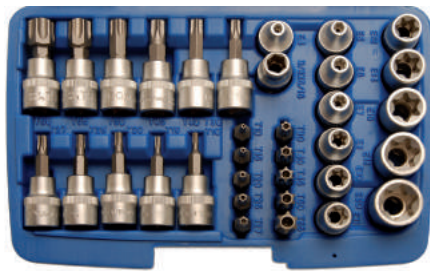

TORX®
TORX® CON FORO TORX®



3/8" ESAGONO 5/16" C

PRO+

CV

BGS articolo	DESCRIZIONE	Euro
BGS 5021	SET 34 PEZZI, CHIAVI A BUSSOLA TORX	63,62

CARATTERISTICHE

- satinare cromate
- 11 chiavi a bussola attacco 3/8": T10 - T60
- 10 inserti Torx c/foro attacco 5/16": T10 - T55
- 1 adattatore per inserti attacco da 3/8"
- 12 bussole Torx E4 - E20



TORX®
TORX® CON FORO

1/4"-3/8"

ESAGONO 5/16" C



PRO+

CV

BGS articolo	DESCRIZIONE	Euro
BGS 5023	SET 17 PEZZI, BUSSOLE E INSERTI TORX	29,23

CARATTERISTICHE

- bussole
 - attacco 1/4": E 6-7-8
 - attacco 3/8": E 10-12-14-16
- 9 inserti Torx c/foro attacco esagonale 5/16": TH 10-15-20-25-30-40-45-50-55
- adattatore portainseri attacco quadro 3/8" x 5/16" esagonale

RICAMBI

BGS articolo	DESCRIZIONE	Euro
BGS 5023-LEER	CASSETTA VUOTA	7,14



1/4"-3/8"-1/2"



TORX®

- 5 BUSSOLE TORX® FEMMINA ATT. 1/4" E 4-5-6-7-8
- 5 BUSSOLE TORX® FEMMINA ATT. 3/8" E 10-11-12-14-16
- 4 BUSSOLE TORX® FEMMINA ATT. 1/2" E 18-20-22-24

Attacco: 1/4" - 3/8" - 1/2"
impronta: TORX®

BGS articolo	Descrizione	Euro
54214	CASSETTA PLASTICA 14 PEZZI	44,10

TORX®

	S mm	S mm	
E 4	3.70	E 16	14.60
E 5	4.60	E 18	16.50
E 6	5.60	E 20	18.30
E 7	6.10	E 22	20.10
E 8	7.40	E 24	22.00
E 10	9.30	E 26	23.70
E 11	9.90	E 28	25.50
E 12	11.00	E 30	27.30
E 14	12.80	E 32	29.00



1/4"-3/8"-1/2"-3/4"



1/4"-3/8"-1/2"-3/4"

RACCORDI DI RIDUZIONE CHROM-VANADIUM

attacco: 1/4" - 3/8" - 1/2" - 3/4"

BGS articolo	FEMMINA	MASCHIO	Euro
BGS 271	1/4"	3/8"	3,15
BGS 269	3/8"	1/4"	3,15
BGS 280	3/8"	1/2"	3,68
BGS 270	1/2"	3/8"	3,68
BGS 272	1/2"	3/4"	8,40
BGS 274	3/4"	1/2"	8,40

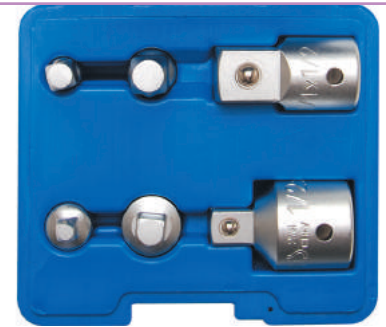

PRO+

CV

BGS articolo	DESCRIZIONE	Euro
BGS 199	SET 6 PEZZI ADATTATORI	24,23

CARATTERISTICHE

- cromati satinati

CONTENUTO

- 1/4" F X 3/8" M, coppia massima 60 Nm
- 3/8" F X 1/4" M, coppia massima 60 Nm
- 3/8" F X 1/2" M, coppia massima 200 Nm
- 1/2" F X 3/8" M, coppia massima 200 Nm
- 1/2" F X 3/4" M, coppia massima 500 Nm
- 3/4" F X 1/2" M, coppia massima 500 Nm

RICAMBI

BGS articolo	DESCRIZIONE	Euro
BGS 199-LEER	CASSETTA VUOTA	5,36



4x

Steckschlüssel-Adapter-Satz

6.3 1/4" x 10 3/8"
10 3/8" x 6.3 1/4"
10 3/8" x 12.5 1/2"
12.5 1/2" x 10 3/8"

Tipps + Trends

Art. 8808



1/4"-3/8"-1/2"



CV

BGS articolo	DESCRIZIONE	Euro
BGS 8808	SET 4 PEZZI, RIDUZIONI	10,25

CARATTERISTICHE

- comprende 4 riduzioni:
 - 1/4" F - 3/8" M
 - 3/8" F - 1/4" M
 - 3/8" F - 1/2" M
 - 1/2" F - 3/8" M
- finitura cromata satinata



3/8

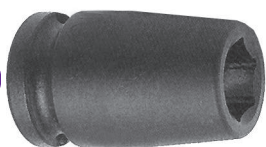

ESAGONO

BUSSOLE POWER IMPACT

attacco: 3/8"

impronta: ESAGONO

articolo	mm	L mm		Euro
196-6	6	30	1	6,55
196-7	7	30	1	6,55
196-8	8	30	1	6,55
196-9	9	30	1	6,55
196-10	10	30	1	6,55
196-11	11	30	1	6,55
196-12	12	30	1	6,55
196-13	13	30	1	6,93
196-14	14	30	1	6,93
196-15	15	30	1	6,93
196-16	16	30	1	6,93
196-17	17	30	1	6,93
196-18	18	30	1	7,46
196-19	19	30	1	7,46
196-20	20	30	1	7,57
196-21	21	30	1	7,94
196-22	22	30	1	8,69
196-23	23	30	1	10,08
196-24	24	30	1	10,86

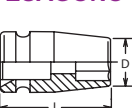

CHIAVI A BUSSOLA A MACCHINA BOCCA ESAGONALE

articolo	mm	D mm	L mm		Euro
13400M-6	6	10.8	32	1	7,84
13400M-7	7	12	32	1	7,84
13400M-8	8	13.3	32	1	7,84
13400M-9	9	14.5	32	1	7,84
13400M-10	10	15.8	32	1	7,84
13400M-11	11	17	32	1	7,84
13400M-12	12	18.3	32	1	7,84
13400M-13	13	19.5	32	1	8,36
13400M-14	14	20.8	32	1	8,36
13400M-15	15	22	32	1	8,36
13400M-16	16	23.3	32	1	8,36
13400M-17	17	24.5	32	1	8,36
13400M-18	18	25.8	32	1	8,94
13400M-19	19	27	32	1	8,94
13400M-20	20	28.3	32	1	9,46
13400M-21	21	29.5	32	1	9,79
13400M-22	22	30.8	32	1	10,84
13400M-23	23	32	32	1	12,54
13400M-24	24	33.3	32	1	13,64



articolo	DESCRIZIONE	Euro
13241M	Set chiavi a bussola 11 Pezzi in cassetta metallica	101,75
RICAMBI		
BUSSOLE		
ESAGONO	13400M 9, 10, 11, 12, 13, 14, 15, 16, 17, 18, 19	



articolo	DESCRIZIONE	Euro
13242M	Set chiavi a bussola 11 Pezzi in cassetta metallica 310 x 90 x h 48 mm con scomparto portautensili vuoto	115,20
RICAMBI		
BUSSOLE		
ESAGONO	13400M 9, 10, 11, 12, 13, 14, 15, 16, 17, 18, 19	

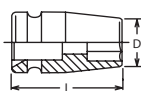

CHIAVI A BUSSOLA A MACCHINA BOCCA ESAGONALE CON RIVESTIMENTO

articolo	mm	D mm	L mm		Euro
13400M-8FR	8	15.7	32	1	58,66
13400M-10FR	10	18.2	32	1	58,66
13400M-12FR	12	20.8	32	1	58,66
13400M-13FR	13	23.6	32	1	67,07
13400M-14FR	14	21.8	32	1	67,07
13400M-16FR	16	26.1	32	1	67,07
13400M-17FR	17	27.3	32	1	67,07

POLLICI

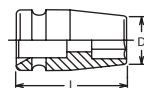

CHIAVI A BUSSOLA A MACCHINA BOCCA ESAGONALE

articolo	pollici	D mm	L mm		Euro
13400A-1/4	1/4"	10.8	32	1	8,42
13400A-5/16	5/16"	13.3	32	1	8,42
13400A-3/8	3/8"	15.8	32	1	8,42
13400A-7/16	7/16"	17	32	1	8,42
13400A-1/2	1/2"	19.5	32	1	9,02
13400A-9/16	9/16"	20.8	32	1	9,02
13400A-5/8	5/8"	23.3	32	1	9,02
13400A-11/16	11/16"	24.5	32	1	9,60
13400A-3/4	3/4"	27	32	1	9,60
13400A-13/16	13/16"	29.5	32	1	10,56
13400A-7/8	7/8"	30.8	32	1	11,66

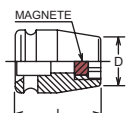

CHIAVI A BUSSOLA A MACCHINA BOCCA ESAGONALE CON MAGNETE

articolo	mm	D mm	L mm			Euro
13400MG-6	6	10.8	32	1		13,17
13400MG-7	7	12	32	1		13,42
13400MG-8	8	13.3	32	1		13,86
13400MG-9	9	14.5	32	1		13,86
13400MG-10	10	15.8	32	1		14,16
13400MG-11	11	17	32	1		14,16
13400MG-12	12	18.3	32	1		14,16
13400MG-13	13	19.5	32	1		14,33
13400MG-14	14	20.8	32	1		20,68
13400MG-15	15	22	32	1		20,96
13400MG-16	16	23.3	32	1		22,00
13400MG-17	17	24.5	32	1		22,00
13400MG-18	18	25.8	32	1		23,51
13400MG-19	19	27	32	1		23,98
13400MG-21	21	29.5	32	1		39,93
13400MG-22	22	30.8	32	1		40,56





ESAGONO

CHIAVI A BUSSOLA
A MACCHINA EXTRA CORTE
RIBASSATE
BOCCA ESAGONALE



Koken articolo	mm	D mm	L mm	Euro
13401MS-8	8	12.3	22	18,18
13401MS-10	10	14.8	22	18,18
13401MS-12	12	17.3	22	18,18
13401MS-13	13	18.5	22	19,11
13401MS-14	14	19.8	22	19,11

POLLICI



POLIGONALE

CHIAVI A BUSSOLA
A MACCHINA
BOCCA POLIGONALE

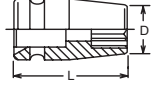

Koken articolo	pollici	D mm	L mm	Euro
13405A-1/4	1/4"	10.8	32	8,86
13405A-5/16	5/16"	13.3	32	8,86
13405A-3/8	3/8"	15.8	32	8,86
13405A-7/16	7/16"	17	32	8,86
13405A-1/2	1/2"	19.5	32	9,43
13405A-9/16	9/16"	20.8	32	9,43
13405A-5/8	5/8"	23.3	32	9,43
13405A-11/16	11/16"	24.5	32	10,15
13405A-3/4	3/4"	27	32	10,15
13405A-13/16	13/16"	29.5	32	11,08
13405A-7/8	7/8"	30.8	32	12,24



SURFACE DRIVE

CHIAVI A BUSSOLA
A MACCHINA BOCCA
SURFACE DRIVE

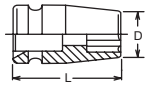

Koken articolo	mm	D mm	L mm	Euro
13410M-6	6	10.8	32	8,20
13410M-7	7	12	32	8,20
13410M-8	8	13.3	32	8,20
13410M-9	9	14.5	32	8,20
13410M-10	10	15.8	32	8,20
13410M-11	11	17	32	8,20
13410M-12	12	18.3	32	8,20
13410M-13	13	19	32	8,77
13410M-14	14	20.8	32	8,77
13410M-15	15	22	32	8,77
13410M-16	16	23.3	32	8,77
13410M-17	17	24.5	32	8,77
13410M-18	18	25.8	32	9,35
13410M-19	19	27	32	9,35
13410M-22	22	30.8	32	11,36



POLIGONALE

CHIAVI A BUSSOLA
A MACCHINA
BOCCA POLIGONALE

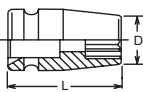

Koken articolo	mm	D mm	L mm	Euro
13405M-8	8	13.3	32	8,42
13405M-9	9	14.5	32	8,42
13405M-10	10	15.8	32	8,42
13405M-11	11	17	32	8,42
13405M-12	12	18.3	32	8,42
13405M-13	13	19.5	32	9,02
13405M-14	14	20.8	32	9,02
13405M-15	15	22	32	9,02
13405M-16	16	23.3	32	9,02
13405M-17	17	24.5	32	9,02
13405M-18	18	25.8	32	9,60
13405M-19	19	27	32	9,60

PARETI SOTTILI



POLIGONALE

CHIAVI A BUSSOLA
A MACCHINA
BOCCA POLIGONALE
PARETI SOTTILI

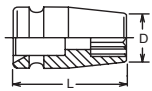

Koken articolo	mm	D mm	L mm	Euro
13406M-6	6	9.8	32	8,42
13406M-7	7	11	32	8,42
13406M-8	8	12.3	32	8,42
13406M-9	9	13.5	32	8,42
13406M-10	10	14.8	32	8,42
13406M-11	11	16	32	8,42
13406M-12	12	17.3	32	8,42
13406M-13	13	18.5	32	9,02
13406M-14	14	19.8	32	9,02
13406M-15	15	21	32	9,02
13406M-16	16	22.3	32	9,02
13406M-17	17	23.5	32	9,02
13406M-18	18	24.8	32	9,60
13406M-19	19	26	32	9,60
13406M-20	20	27.3	32	10,18
13406M-21	21	28.5	32	10,56
13406M-22	22	29.8	32	11,66
13406M-23	23	31	32	13,53
13406M-24	24	32.3	32	14,66



FAST LEAD

CHIAVI A BUSSOLA
A MACCHINA BOCCA
FAST LEAD

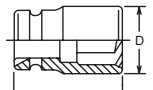

Koken articolo	mm	D mm	L mm	Euro
13465M-8	8	13.3	32	12,90
13465M-10	10	15.8	32	12,90
13465M-11	11	17	32	12,90
13465M-12	12	18.3	32	12,90
13465M-13	13	19.5	32	12,90
13465M-14	14	20.8	32	12,90
13465M-15	15	22	32	12,90
13465M-16	16	23.3	32	13,23
13465M-17	17	24.5	32	13,23
13465M-18	18	25.8	32	13,23
13465M-19	19	27	32	13,94





CHIAVI A BUSSOLA
A MACCHINA
BOCCA LHSTIX®

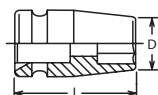

Kokon articolo		D mm	L mm		Euro
13401LH-5S	5S	11	32	1	13,64
13401LH-6S	6S	12.3	32	1	13,64
13401LH-8S	8S	16	32	1	13,64
13401LH-10S	10S	18.5	32	1	14,08
13401LH-12S	12S	22.3	32	1	14,71
13401LH-14S	14S	24.8	32	1	15,62
13401LH-16S	16S	28.5	32	1	16,80

LHSTIX®

d mm D mm

LH 3 S	3.80	4.70
LH 4 S	4.50	6.00
LH 5 S	5.60	7.50
LH 6 S	6.80	9.00
LH 7 S	7.90	10.50
LH 8 S	9.00	12.00
LH 10 S	11.30	15.00
LH 12 S	13.60	18.00
LH 14 S	15.80	21.00
LH 16 S	18.10	24.00



d

D

D

d

D

d

D

d

D

d

D

d

D

d

D

d

D

d

D

d

D

d

D

d

D

d

D

d

D

d

D

d

D

d

D

d

D

d

D

d

D

d

D

d

D

d

D



articolo

DESCRIZIONE

Euro

611092

Set chiavi a bussola
9 Pezzi
in cassetta metallica

63,00

CARATTERISTICHE



E 5-6-7-8-10-11-12-14-16



CHIAVI A BUSSOLA
A MACCHINA
BOCCA TORX PLUS®

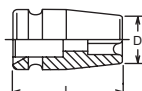

articolo

DESCRIZIONE

Euro

13425-8EPL

8 12 32 1 19,77

13425-10EPL

10 13.3 32 1 19,77

NEW 13425-12EPL 12 15.8 32 1 22,22

NEW 13425-14EPL 14 18.3 32 1 22,22

NEW 13425-16EPL 16 19.5 32 1 22,22

TORX PLUS®

S mm

S mm

E 4 3.70 E 16 14.60

E 5 4.60 E 18 16.50

E 6 5.60 E 20 18.30

E 7 6.10 E 22 20.10

E 8 7.40 E 24 22.00

E 10 9.30 E 26 23.70

E 11 9.90 E 28 25.50

E 12 11.00 E 30 27.30

E 14 12.80 E 32 29.00



CHIAVI A BUSSOLA
A MACCHINA BOCCA
TORX®

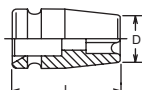

Kokon

articolo

DESCRIZIONE

D mm

L mm

Euro

13425-E 4 E 4 9.7 32 1 9,82

13425-E 5 E 5 10.2 32 1 9,82

13425-E 6 E 6 10.7 32 1 9,82

13425-E 7 E 7 11.2 32 1 9,82

13425-E 8 E 8 11.7 32 1 9,82

13425-E10 E10 12.2 32 1 9,82

NEW 13425-E11 E11 13.2 32 1 9,82

13425-E12 E12 14.2 32 1 9,82

13425-E14 E14 17.2 32 1 9,82

13425-E16 E16 18.2 32 1 10,04

TORX PLUS®

S mm

S mm

E 4 3.70 E 16 14.60

E 5 4.60 E 18 16.50

E 6 5.60 E 20 18.30

E 7 6.10 E 22 20.10

E 8 7.40 E 24 22.00

E 10 9.30 E 26 23.70

E 11 9.90 E 28 25.50

E 12 11.00 E 30 27.30

E 14 12.80 E 32 29.00



CHIAVI A BUSSOLA
A MACCHINA
BOCCA QUADRA

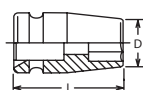

Kokon

articolo

DESCRIZIONE

D mm

L mm

Euro

13400WN-6

6 15.8 32 1 35,70

13400WN-8

8 18.3 32 1 35,70

13400WN-9

9 19.5 32 1 35,70

13400WN-10

10 20.8 32 1 35,70

13400WN-12

12 24.5 32 1 36,82

13400WN-14

14 27 32 1 36,82

13400WN-17

17 32 32 1 38,39

PARETI SOTTILI
SU TUTTO IL CORPO

CHIAVI A BUSSOLA
POWER
BOCCA ESAGONALE

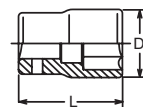

Kokon

articolo

D mm

L mm

Euro

23400M-6

6 9.9 26 1 6,22

23400M-7

7 10.8 26 1 6,22

23400M-8

8 13.9 26 1 6,22

23400M-10

10 14.5 26 1 6,22

23400M-11

11 15.8 26 1 6,22

23400M-12

12 16.8 26 1 6,22

23400M-13

13 18 26 1 6,85

23400M-14

14 19.5 27 1 6,90

23400M-15

15 20.8 28 1 7,01

23400M-16

16 22 28 1 7,01

23400M-17

17 23.4 29 1 7,01

23400M-18

18 24.5 30 1 7,01

23400M-19

19 25.8 30 1 7,01

23400M-21

21 28 32 1 9,57

PARETI SOTTILI
SU TUTTO IL CORPO

CHIAVI A BUSSOLA
POWER
BOCCA ESAGONALE

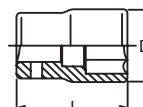

Kokon

articolo

D mm

L mm

Euro

23400A-5/16

5/16" 12 26 1 6,71

23400A-3/8

3/8" 13.9 26 1 6,71

23400A-7/16

7/16" 15.8 26 1 6,71

23400A-1/2

1/2" 18 26 1 7,40

23400A-9/16

9/16" 19.5 27 1 7,45

23400A-11/16

11/16" 24.5 30 1 7,56

23400A-3/4

3/4" 25.8 30 1 7,56

PARETI SOTTILI
SU TUTTO IL CORPO

CHIAVI A BUSSOLA
POWER
BOCCA POLIGONALE

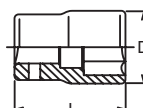

Kokon

articolo

D mm

L mm

Euro

23405M-8

8 12 26 1 6,55

23405M-10

10 14.5 26 1 6,55

23405M-12

12 16.8 26 1 6,55

23405M-14

14 19.5 27 1 7,62



PARETI SOTTILI
SU TUTTO IL CORPO



**SURFACE
DRIVE**

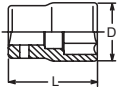

**CHIAVI A BUSSOLA
POWER
BOCCA SURFACE DRIVE**

Koken articolo	mm	D mm	L mm		Euro
23410M-8	8	12	26	1	6,55
23410M-10	10	14.5	26	1	6,55
23410M-12	12	16.8	26	1	6,55
23410M-13	13	18	26	1	7,62
23410M-14	14	19.5	27	1	7,62
23410M-15	15	21	28	1	8,17
23410M-16	16	22	28	1	8,17
23410M-17	17	23.5	29	1	8,17
23410M-18	18	24.6	30	1	8,47
23410M-19	19	26	30	1	8,47

PARETI SOTTILI
SU TUTTO IL CORPO



TORX®

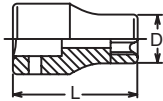

**CHIAVI A BUSSOLA
POWER
BOCCA TORX®**

Koken articolo		D mm	L mm		Euro
23425-E 5	E 5	10.2	26	1	7,32
23425-E 6	E 6	10.7	26	1	7,32
23425-E 7	E 7	11.2	26	1	7,32
23425-E 8	E 8	11.7	26	1	7,32
23425-E10	E10	12.2	26	1	7,32
23425-E11	E11	13.3	26	1	7,32
23425-E12	E12	14.2	26	1	7,32
23425-E14	E14	17.2	26	1	7,32
23425-E16	E16	18.2	26	1	7,73

TORX®		S mm	S mm
E 4	E 16	3.70	14.60
E 5	E 18	4.60	16.50
E 6	E 20	5.60	18.30
E 7	E 22	6.10	20.10
E 8	E 24	7.40	22.00
E 10	E 26	9.30	23.70
E 11	E 28	9.90	25.50
E 12	E 30	11.00	27.30
E 14	E 32	12.80	29.00



3/8

ESAGONO

LUNGHE

attacco: 3/8"
impronta: ESAGONO

Koken articolo	mm	L mm		Euro
196-8 L	8	65	1	11,47
196-9 L	9	65	1	11,47
196-10 L	10	65	1	11,47
196-11 L	11	65	1	11,47
196-12 L	12	65	1	11,47
196-13 L	13	65	1	13,28
196-14 L	14	65	1	13,28
196-15 L	15	65	1	13,28
196-16 L	16	65	1	13,28
196-17 L	17	65	1	13,28
196-18 L	18	65	1	13,28
196-19 L	19	65	1	13,28
196-20 L	20	65	1	15,70
196-21 L	21	65	1	15,70
196-22 L	22	65	1	16,30
196-23 L	23	65	1	16,30



ESAGONO

**CHIAVI A BUSSOLA
A MACCHINA BOCCA
ESAGONALE
TIPO LUNGO**

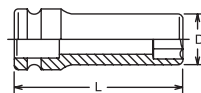

Koken articolo	mm	D mm	L mm		Euro
13300M-6	6	10.8	80	1	13,53
13300M-7	7	12	80	1	13,53
13300M-8	8	13.3	80	1	13,53
13300M-9	9	14.5	80	1	13,53
13300M-10	10	15.8	80	1	13,53
13300M-11	11	17	80	1	13,53
13300M-12	12	18.3	80	1	13,53
13300M-13	13	19.5	80	1	14,99
13300M-14	14	20.8	80	1	14,99
13300M-15	15	22	80	1	14,99
13300M-16	16	23.3	80	1	14,99
13300M-17	17	24.5	80	1	14,99
13300M-18	18	25.8	80	1	15,35
13300M-19	19	27	80	1	17,99
13300M-20	20	28.3	80	1	18,29
13300M-21	21	29.5	80	1	19,22
13300M-22	22	30.8	80	1	20,43
13300M-24	24	33.2	80	1	23,07

POLLICI



ESAGONO

**CHIAVI A BUSSOLA
A MACCHINA BOCCA
ESAGONALE
TIPO LUNGO**

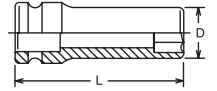

Koken articolo	pollici	D mm	L mm		Euro
13300A-1/4	1/4"	10.8	80	1	14,58
13300A-5/16	5/16"	13.3	80	1	14,58
13300A-3/8	3/8"	15.8	80	1	14,58
13300A-7/16	7/16"	17	80	1	14,58
13300A-1/2	1/2"	19.5	80	1	16,20
13300A-9/16	9/16"	20.8	80	1	16,20
13300A-5/8	5/8"	23.3	80	1	16,20
13300A-11/16	11/16"	24.5	80	1	16,56
13300A-3/4	3/4"	27	80	1	19,42
13300A-13/16	13/16"	29.5	80	1	20,71
13300A-7/8	7/8"	30.8	80	1	22,03

PARETI SOTTILI



ESAGONO

**CHIAVI A BUSSOLA
A MACCHINA BOCCA
ESAGONALE
TIPO LUNGO
PARETI SOTTILI**

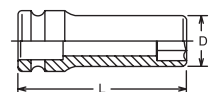

Koken articolo	mm	D mm	L mm		Euro
13301M-6	6	10	80	1	13,89
13301M-7	7	11	80	1	13,89
13301M-8	8	12.3	80	1	13,89
13301M-9	9	13.5	80	1	13,89
13301M-10	10	14.8	80	1	13,89
13301M-11	11	16	80	1	13,89
13301M-12	12	17.3	80	1	13,89
13301M-13	13	18.5	80	1	15,40
13301M-14	14	19.8	80	1	15,40
13301M-15	15	21	80	1	15,40
13301M-16	16	22.3	80	1	15,40
13301M-17	17	23.5	80	1	15,40
13301M-18	18	24.8	80	1	15,76
13301M-19	19	26	80	1	18,45
13301M-20	20	23.7	80	1	18,78
13301M-21	21	28.5	80	1	19,75
13301M-22	22	29.8	80	1	20,96
13301M-24	24	32.3	80	1	23,68

IMPACT 3/8"

PARETI SOTTILI

SEMI-LUNGA



ESAGONO

CHIAVI A BUSSOLA
A MACCHINA BOCCA
ESAGONALE
PARETI SOTTILI
TIPO SEMI-LUNGO

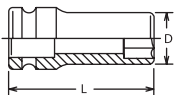

Koken articolo	mm	D mm	L mm		Euro
NEW 13301X-7	7	11	50	1	12,84
13301X-8	8	12.3	50	1	12,84
13301X-10	10	14.8	50	1	12,84
13301X-11	11	16	50	1	12,84
13301X-12	12	17.3	50	1	12,84
13301X-13	13	18.5	50	1	14,27
13301X-14	14	19.8	50	1	14,27
13301X-15	15	21	50	1	14,27
13301X-16	16	22.3	50	1	14,27
13301X-17	17	23.5	50	1	14,55
13301X-18	18	24.8	50	1	16,36
13301X-19	19	26	50	1	16,80
13301X-21	21	28.5	50	1	17,93
13301X-22	22	29.8	50	1	19,22
13301X-23	23	31	50	1	20,68
13301X-24	24	32.3	50	1	21,20



**SURFACE
DRIVE**

CHIAVI A BUSSOLA
A MACCHINA BOCCA
SURFACE DRIVE
TIPO LUNGO

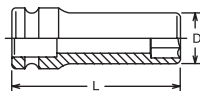

Koken articolo	mm	D mm	L mm		Euro
NEW 13310M-7	7	11	80	1	14,22
13310M-8	8	13.3	80	1	14,22
13310M-9	9	14.5	80	1	14,22
13310M-10	10	15.8	80	1	14,22
13310M-11	11	17	80	1	14,22
13310M-12	12	18.3	80	1	14,22
13310M-13	13	19.5	80	1	15,79
13310M-14	14	20.8	80	1	15,79
13310M-15	15	22	80	1	15,79
13310M-16	16	23.3	80	1	15,79
13310M-17	17	24.5	80	1	15,79
NEW 13310M-18	18	25.8	80	1	18,51
13310M-19	19	27	80	1	18,92



POLIGONALE

CHIAVI A BUSSOLA
A MACCHINA BOCCA
POLIGONALE
TIPO LUNGO

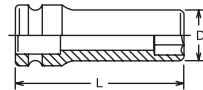

Koken articolo	mm	D mm	L mm		Euro
13305M-8	8	13.3	80	1	14,16
13305M-10	10	15.8	80	1	14,16
NEW 13305M-11	11	17	80	1	14,16
13305M-12	12	18.3	80	1	14,16
13305M-13	13	19.5	80	1	15,68
13305M-14	14	20.8	80	1	15,68
13305M-17	17	24.5	80	1	15,68

IMPACT 3/8"

PARETI SOTTILI

NEW



POLIGONALE

CHIAVI A BUSSOLA
A MACCHINA BOCCA
POLIGONALE
TIPO LUNGO
PARETI SOTTILI

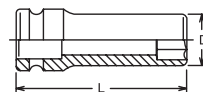

Koken articolo	mm	D mm	L mm		Euro
13306M-8	8	12.3	80	1	14,16
13306M-10	10	14.8	80	1	14,16
13306M-11	11	16	80	1	14,16
13306M-12	12	17.3	80	1	14,16
13306M-13	13	18.5	80	1	15,68
13306M-14	14	19.8	80	1	15,68
13306M-17	17	23.5	80	1	15,68



ESAGONO



CHIAVI A BUSSOLA
A MACCHINA BOCCA
ESAGONALE
CON MAGNETE
RETRATTILE

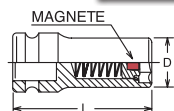

Koken articolo	mm	D mm	L mm		Euro
NEW 13300XG-7	7	12	50	1	26,24
13300XG-8	8	13.3	50	1	26,24
13300XG-10	10	15.8	50	1	26,24
NEW 13300XG11	11	17	50	1	26,24
13300XG-12	12	18.3	50	1	26,24
13300XG-13	13	19.5	50	1	29,45
13300XG-14	14	20.8	50	1	29,59
13300G-8	8	13.3	80	1	28,22
13300G-10	10	15.8	80	1	28,22
13300G-12	12	18.3	80	1	28,22
13300G-13	13	19.5	80	1	31,19
13300G-14	14	20.8	80	1	31,19
13300G-15	15	22	80	1	31,52
NEW 13300G-16	16	23.3	80	1	31,52
13300G-17	17	24.5	80	1	31,52
13300G-19	19	27	80	1	44,11



FAST LEAD

CHIAVI A BUSSOLA
A MACCHINA BOCCA
FAST LEAD
TIPO LUNGO

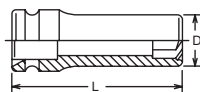

Koken articolo	mm	D mm	L mm		Euro
NEW 13365M-8	8	13.3	80	1	18,56
13365M-10	10	15.8	80	1	18,56
13365M-11	11	17	80	1	18,56
13365M-12	12	18.3	80	1	18,56
13365M-13	13	19.5	80	1	19,22
13365M-14	14	20.8	80	1	19,22
13365M-15	15	22	80	1	19,22
13365M-16	16	23.3	80	1	19,22
13365M-17	17	24.5	80	1	19,22
13365M-18	18	25.8	80	1	20,43
13365M-19	19	27	80	1	20,43





CHIAVI A BUSSOLA
POWER
BOCCA ESAGONALE
TIPO LUNGO

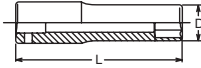

Koken articolo	mm	D mm	L mm		Euro
23300M-7	7	10.6	55	1	10,81
23300M-8	8	12	55	1	10,81
23300M-10	10	14.5	55	1	10,81
23300M-11	11	16	55	1	10,81
23300M-12	12	16.8	55	1	10,81
23300M-13	13	18	55	1	11,77
23300M-14	14	20	55	1	11,77
23300M-15	15	21	55	1	11,77
23300M-16	16	22	55	1	11,77
23300M-17	17	23.5	55	1	11,77
23300M-18	18	24.5	55	1	13,59
23300M-19	19	25	55	1	13,59



CHIAVI A BUSSOLA
POWER
BOCCA ESAGONALE
TIPO LUNGO

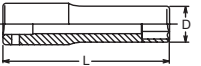

Koken articolo	pollici	D mm	L mm		Euro
23300A-5/16	5/16"	12	55	1	10,01
23300A-3/8	3/8"	14	55	1	10,09
23300A-7/16	7/16"	16	55	1	11,63
23300A-1/2	1/2"	18	55	1	12,65
23300A-9/16	9/16"	20	55	1	12,65
23300A-11/16	11/16"	23.5	55	1	14,63
23300A-3/4	3/4"	25	55	1	14,63



CHIAVI A BUSSOLA
POWER
BOCCA POLIGONALE
TIPO LUNGO

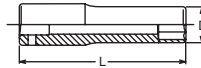

Koken articolo	mm	D mm	L mm		Euro
23305M-8	8	12	55	1	11,96
23305M-10	10	14.5	55	1	11,96
23305M-12	12	16.8	55	1	11,96
23305M-14	14	20	55	1	13,42



CHIAVI A BUSSOLA
POWER
BOCCA SURFACE
DRIVE TIPO LUNGO

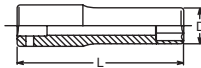

Koken articolo	mm	D mm	L mm		Euro
23310M-8	8	12	55	1	11,96
23310M-10	10	14.5	55	1	11,96
23310M-12	12	16.8	55	1	11,96
23310M-13	13	18	55	1	13,42
23310M-14	14	19.5	55	1	13,42
23310M-15	15	21	55	1	13,42
23310M-17	17	23.5	55	1	13,42



CHIAVI A BUSSOLA
POWER
BOCCA TORX®
TIPO LUNGO

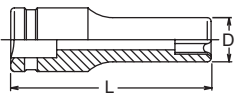

Koken articolo		D mm	L mm		Euro
23325-E 5	E 5	10.2	55	1	12,49
23325-E 6	E 6	10.7	55	1	12,49
23325-E 7	E 7	11.2	55	1	12,49
23325-E 8	E 8	11.7	55	1	12,49
23325-E10	E10	12.2	55	1	12,49
23325-E12	E12	14.2	55	1	12,49
23325-E14	E14	17.2	55	1	12,49
23325-E16	E16	18.2	55	1	13,23



CHIAVI A BUSSOLA
A MACCHINA BOCCA
ESAGONALE
TIPO EXTRA LUNGO

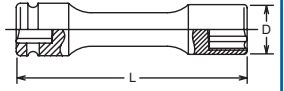

Koken articolo	mm	D mm	L mm		Euro
13145M-100-8	8	13.3	100	1	24,78
13145M-100-10	10	15.8	100	1	24,78
13145M-100-12	12	18.3	100	1	24,78
13145M-100-13	13	19.5	100	1	29,21
13145M-100-14	14	20.8	100	1	29,21
13145M-100-17	17	24.5	100	1	29,21
13145M-150-6	6	10.8	150	1	32,23
13145M-150-8	8	13.3	150	1	32,23
13145M-150-10	10	15.8	150	1	32,23
13145M-150-12	12	18.3	150	1	32,23
13145M-150-13	13	19.5	150	1	33,03
13145M-150-14	14	20.8	150	1	33,03
13145M-150-15	15	22	150	1	33,03
13145M-150-17	17	24.5	150	1	33,03
13145M-200-6	6	10.8	200	1	36,47
13145M-200-8	8	13.3	200	1	36,47
13145M-200-10	10	15.8	200	1	36,47
13145M-200-12	12	18.3	200	1	36,47
13145M-200-13	13	19.5	200	1	36,63
13145M-200-14	14	20.8	200	1	36,63
13145M-200-15	15	22	200	1	36,63
13145M-200-17	17	24.5	200	1	36,63
13145M-250-6	6	10.8	250	1	37,32
13145M-250-8	8	13.3	250	1	37,32
13145M-250-10	10	15.8	250	1	37,32
13145M-250-12	12	18.3	250	1	37,32
13145M-250-13	13	19.5	250	1	37,46
13145M-250-14	14	20.8	250	1	37,46
13145M-250-15	15	22	250	1	37,46
13145M-250-17	17	24.5	250	1	37,46
13145A-150-9/16	9/16"	20	150	1	38,17



TORX®		S mm	S mm	
	E 4	3.70	E 16	14.60
	E 5	4.60	E 18	16.50
	E 6	5.60	E 20	18.30
	E 7	6.10	E 22	20.10
	E 8	7.40	E 24	22.00
	E 10	9.30	E 26	23.70
	E 11	9.90	E 28	25.50
	E 12	11.00	E 30	27.30
	E 14	12.80	E 32	29.00



CHIAVI A
BUSSOLA
A MACCHINA
BOCCA
ESAGONALE
TIPO EXTRA
LUNGO CON
MAGNETE

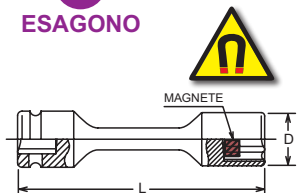

Koken articolo	mm	D mm	L mm		Euro
13145MG-100-8	8	13.3	100	1	52,09
13145MG-100-10	10	15.8	100	1	52,09
13145MG-100-12	12	18.3	100	1	53,57
13145MG-100-13	13	20.8	100	1	57,61
13145MG-100-14	14	20.8	100	1	57,61
13145MG-150-10	10	15.8	150	1	60,67
13145MG-150-12	12	18.3	150	1	61,71
13145MG-150-13	13	20.8	150	1	64,05
13145MG-150-14	14	24.5	150	1	64,05
13145MG-200-10	10	15.8	200	1	62,59
13145MG-200-12	12	18.3	200	1	62,59
13145MG-200-13	13	20.8	200	1	66,47
13145MG-200-14	14	24.5	200	1	66,47



CHIAVI A
BUSSOLA
A MACCHINA
BOCCA
POLIGONALE 12
PUNTI
EXTRA LUNGHE



Koken articolo	mm	D mm	L mm		Euro
13145M-100-12P-10	10	15.8	100	1	27,39
13145M-100-12P-12	12	18.3	100	1	27,39
13145M-150-12P-10	10	15.8	150	1	34,16
13145M-150-12P-12	12	18.3	150	1	34,16
13145M-200-12P-10	10	15.8	200	1	37,68
13145M-200-12P-12	12	18.3	200	1	37,68



CHIAVI A BUSSOLA
A MACCHINA
BOCCA
ESAGONALE
TIPO EXTRA
LUNGO SNODATA

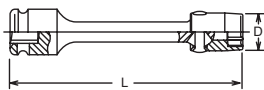

Koken articolo	mm	D mm	L mm		Euro
13146M-150-8	8	12	150	1	60,01
13146M-150-10	10	14.3	150	1	60,01
13146M-150-12	12	18	150	1	60,01
13146M-150-13	13	19.3	150	1	60,01
13146M-150-14	14	20	150	1	60,01
13146M-200-8	8	12	200	1	63,55
13146M-200-10	10	14.3	200	1	63,55
13146M-200-12	12	18	200	1	63,55
13146M-200-13	13	19.3	200	1	63,55
13146M-200-14	14	20	200	1	63,55
13146M-250-8	8	12	250	1	64,68
13146M-250-10	10	14.3	250	1	64,68
13146M-250-12	12	18	250	1	64,68
13146M-250-13	13	19.3	250	1	64,68
13146M-250-14	14	20	250	1	64,68



CHIAVI A BUSSOLA
A MACCHINA
SNODATE
BOCCA ESAGONALE

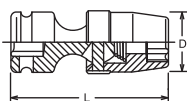

Koken articolo	mm	D mm	L mm		Euro
13440M-10	10	15.8	57	1	40,51
13440M-11	11	17	57	1	40,51
13440M-12	12	18.3	57	1	40,51
13440M-13	13	19.5	57	1	40,51
13440M-14	14	20.8	59	1	40,51
13440M-15	15	22	59	1	40,51
13440M-16	16	23.3	59	1	40,51
13440M-17	17	24.5	59	1	40,51
13440M-18	18	25.8	61	1	41,58
13440M-19	19	27	61	1	41,58
13440M-20	20	29.5	65	1	44,47
13440M-21	21	30.7	65	1	44,72
13440M-22	22	32	65	1	44,99
13440M-24	24	34.5	67	1	44,99

POLLICI



CHIAVI A BUSSOLA
A MACCHINA
SNODATE
BOCCA ESAGONALE

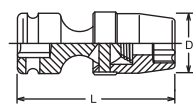

Koken articolo	pollici	D mm	L mm		Euro
13440A-3/8	3/8"	15.8	57	1	43,64
13440A-7/16	7/16"	17	57	1	43,64
13440A-1/2	1/2"	19.5	57	1	43,64
13440A-9/16	9/16"	20.8	59	1	43,64
13440A-5/8	5/8"	23.3	59	1	43,64
13440A-11/16	11/16"	24.5	59	1	44,83
13440A-3/4	3/4"	27	61	1	44,83



CHIAVI A BUSSOLA
A MACCHINA
SNODATE
BOCCA TORX

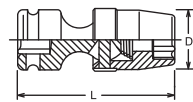

Koken articolo		D mm	L mm		Euro
13440T-E10	E 10	13.3	57.7	1	53,60
13440T-E12	E 12	15.8	57.7	1	53,60
13440T-E14	E 14	17	57.7	1	53,60

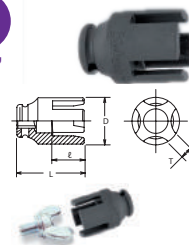

CHIAVE A BUSSOLA PER VITI E DADI CON
ALLETTE - GALLETTO

Koken articolo	T mm	ℓ mm	L mm		Euro
BD018	7,3	21	45	1	25,85



3/8

ESAGONO

BUSSOLE ESAGONALI MASCHIO INTEGRALI

attacco: 3/8"

impronta: ESAGONO MASCHIO

articolo	mm	L mm		Euro
182 - 3/8" - 4 - 36	4	36	1	9,98
182 - 3/8" - 5 - 36	5	36	1	9,98
182 - 3/8" - 6 - 36	6	36	1	9,98
182 - 3/8" - 8 - 36	8	36	1	9,98
182 - 3/8" - 10 - 36	10	36	1	9,98
182 - 3/8" - 4	4	50	1	13,65
182 - 3/8" - 5	5	50	1	13,65
182 - 3/8" - 6	6	50	1	13,65
182 - 3/8" - 7	7	50	1	13,65
182 - 3/8" - 8	8	50	1	13,65
182 - 3/8" - 10	10	50	1	14,70
182 - 3/8" - 12	12	50	1	15,23
182 - 3/8" - 14	14	50	1	16,28
1182 - 3/8" - 4	4	90	1	20,48
1182 - 3/8" - 5	5	90	1	20,48
1182 - 3/8" - 6	6	90	1	20,48
1182 - 3/8" - 8	8	90	1	20,48
2182 - 3/8" - 8	8	125	1	22,48



3/8 ESAGONO

**BUSSOLE IMPACT BRUGOLA
MM 4-5-6-7-8-10-12, LUNGH. 50 MM**

attacco: 3/8"

impronta: ESAGONO MASCHIO

articolo	Descrizione		Euro
511071	CASSETTA METALLICA 7 PEZZI	1	47,25

POLLICI



3/8 ESAGONO

**BUSSOLE IMPACT BRUGOLA
MISURE IN POLLICI - 3/16"-7/32"-1/4"-
9/32"-5/16"-3/8"-7/16" - LUNGH. 50 MM**

attacco: 3/8"

impronta: ESAGONO MASCHIO

articolo	Descrizione		Euro
411071	CASSETTA METALLICA 7 PEZZI	1	47,25



ESAGONO

**CHIAVI A BUSSOLA
A MACCHINA
SNODATE
MASCHIO ESAGONALE**

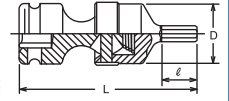

articolo	mm	D mm	l mm	L mm		Euro
13430M-5	5	24	15	74	1	44,72
13430M-6	6	24	15	74	1	44,72
13430M-8	8	24	20	74	1	44,72
13430M-10	10	24	20	74	1	44,72
13430M-17	17	24	7	53	1	55,17



ESAGONO

**CHIAVI A BUSSOLA
A MACCHINA
MASCHIO ESAGONALE
TIPO EXTRA
LUNGO
SNODATA**

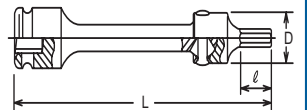

articolo	mm	D mm	l mm	L mm		Euro
13147M-150-4	4	21	15	150	1	62,78
13147M-150-5	5	21	15	150	1	62,78
13147M-150-6	6	21	15	150	1	62,78
13147M-150-8	8	21	15	150	1	62,78
13147M-150-10	10	21	15	150	1	62,78
13147M-200-4	4	21	15	200	1	66,55
13147M-200-5	5	21	15	200	1	66,55
13147M-200-6	6	21	15	200	1	66,55
13147M-200-8	8	21	15	200	1	66,55
13147M-200-10	10	21	15	200	1	66,55



ESAGONO

**CHIAVI A BUSSOLA
A MACCHINA MASCHIO
ESAGONALE - INTEGRALI**

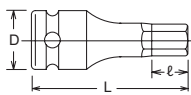

articolo	mm	D mm	l mm	L mm		Euro
13012M-52-3	3	18	10	52	1	14,85
13012M-52-4	4	18	15.5	52	1	14,85
13012M-52-5	5	18	15.5	52	1	14,85
13012M-52-6	6	18	15.5	52	1	14,85
13012M-52-7	7	18	15.5	52	1	15,59
13012M-52-8	8	21	15.5	52	1	15,59
13012M-52-10	10	21	15.5	52	1	15,59
13012M-52-12	12	21	15.5	52	1	17,41
13012M-52-14	14	21	15.5	52	1	20,02



ESAGONO

**SERIE 8 PZ. CHIAVI A BUSSOLA A MACCHINA
MASCHIO ESAGONALE - INTEGRALI**

articolo	mm		Euro
RS13012M/8-L52	4, 5, 6, 7, 8, 10, 12, 14	1	127,85



IMPACT 3/8"



TORX® IMPACT

attacco: 3/8"
impronta: TX

FEARMEC articolo	TORX	L mm	box	Euro
184 - 3/8" - 10 GTX TX 10		50	1	13,50
184 - 3/8" - 15 GTX TX 15		50	1	13,50
184 - 3/8" - 20 GTX TX 20		50	1	13,50
184 - 3/8" - 25 GTX TX 25		50	1	13,50
184 - 3/8" - 27 GTX TX 27		50	1	13,50
184 - 3/8" - 30 GTX TX 30		50	1	13,50
184 - 3/8" - 40 GTX TX 40		50	1	13,50
184 - 3/8" - 45 GTX TX 45		50	1	13,50
184 - 3/8" - 50 GTX TX 50		50	1	13,50



CHIAVI A BUSSOLA A MACCHINA MASCHIO TORX®

Koken articolo	TORX	D mm	L mm	box	Euro
13025-50-T20 TX 20		19	50	1	15,59
13025-50-T25 TX 25		19	50	1	15,59
13025-50-T27 TX 27		19	50	1	15,59
13025-50-T30 TX 30		19	50	1	15,59
13025-50-T40 TX 40		19	50	1	15,59
13025-50-T45 TX 45		19	50	1	15,59
13025-50-T50 TX 50		19	50	1	16,80
13025-50-T55 TX 55		22	50	1	19,86
13025-90-T20 TX 20		19	90	1	18,70
13025-90-T25 TX 25		19	90	1	18,70
13025-90-T27 TX 27		19	90	1	18,70
13025-90-T30 TX 30		19	90	1	18,70
13025-90-T40 TX 40		19	90	1	18,70
13025-90-T45 TX 45		19	90	1	18,70
13025-90-T50 TX 50		19	90	1	20,10
13025-90-T55 TX 55		22	90	1	23,82

TORX®	S mm	S mm	
T 6	1.70	T 40	6.70
T 7	2.00	T 45	7.90
T 8	2.30	T 50	8.90
T 9	2.50	T 55	11.30
T 10	2.70	T 60	13.30
T 15	3.30	T 70	15.60
T 20	3.90	T 80	17.60
T 25	4.50	T 90	20.00
T 27	5.00	T 100	22.20
T 30	5.60		



TORX®

SERIE 8 PZ. CHIAVI A BUSSOLA A MACCHINA MASCHIO TORX®

Koken articolo	TORX	box	Euro
RS13025/8-L50	TX 4, 5, 6, 7, 8, 10, 12, 14	1	126,34



13134-SC



BUSSOLA PORTAINSERTI DA 7/16"

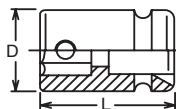

Koken articolo	D mm	L mm	box	Euro
13134	22	32	1	16,14

RICAMBI

Koken articolo	DESCRIZIONE	Euro
13134-SC	GRANO DI RICAMBIO M8X5; ESAGONO 4 MM	1,10

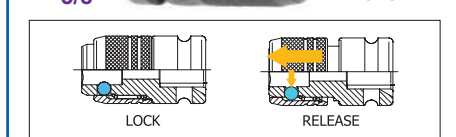

BUSSOLA PORTA INSERTI CON SGANCIO RAPIDO 7/16"

Koken articolo	D mm	L mm	box	Euro
13142-F11.2	22	46	1	44,99



INSERTO CON MASCHIO ESAGONALE

Koken articolo	mm	L mm	box	Euro
183H-35-3	3	35	1	6,90
183H-35-4	4	35	1	6,90
183H-35-5	5	35	1	6,90
183H-35-6	6	35	1	6,90
183H-35-7	7	35	1	7,12
183H-35-8	8	35	1	7,12
183H-35-10	10	35	1	7,12
183H-35-11	11	35	1	11,52
183H-35-12	12	35	1	11,52
183H-35-14	14	35	1	11,96
183H-35-16	16	35	1	11,96
183H-35-17	17	35	1	11,96
183H-35-18	18	35	1	17,77
183H-35-19	19	35	1	17,77
183H-75-3	3	75	1	9,02
183H-75-4	4	75	1	9,02
183H-75-5	5	75	1	9,02
183H-75-6	6	75	1	9,02
183H-75-7	7	75	1	9,02
183H-75-8	8	75	1	9,02
183H-75-10	10	75	1	9,02
183H-75-11	11	75	1	13,09
183H-75-12	12	75	1	13,48
183H-75-14	14	75	1	14,47
183H-150-4	4	150	1	13,75
183H-150-5	5	150	1	13,75
183H-150-6	6	150	1	13,75
183H-150-8	8	150	1	13,75
183H-150-10	10	150	1	13,75
183H-150-12	12	150	1	19,88



INSERTO CON MASCHIO ESAGONALE

Koken articolo	POLLICI	L mm	box	Euro
183H-35-3/16	3/16"	35	1	7,34
183H-35-7/32	7/32"	35	1	7,34
183H-35-1/4	1/4"	35	1	7,34
183H-35-5/16	5/16"	35	1	7,84
183H-35-3/8	3/8"	35	1	7,84
183H-35-7/16	7/16"	35	1	7,84
183H-35-1/2	1/2"	35	1	13,15



**BUSSOLA MASCHIO ESAGONALE
IN DUE PARTI:
BUSSOLA + INSERTO MASCHIO ESAGONALE**

Koken articolo	mm	L mm		Euro
13134M-52-3	3	52	1	23,05
13134M-52-4	4	52	1	23,05
13134M-52-5	5	52	1	23,05
13134M-52-6	6	52	1	23,05
13134M-52-7	7	52	1	23,27
13134M-52-8	8	52	1	23,27
13134M-52-10	10	52	1	23,27
13134M-52-12	12	52	1	27,53
13134M-52-14	14	52	1	27,97
13134M-92-3	3	92	1	24,83
13134M-92-4	4	92	1	24,83
13134M-92-5	5	92	1	24,83
13134M-92-6	6	92	1	24,83
13134M-92-7	7	92	1	24,83
13134M-92-8	8	92	1	24,83
13134M-92-10	10	92	1	24,83
13134M-92-12	12	92	1	29,62
13134M-92-14	14	92	1	30,61

TORX®	S mm	S mm	
T 6	1.70	T 40	6.70
T 7	2.00	T 45	7.90
T 8	2.30	T 50	8.90
T 9	2.50	T 55	11.30
T 10	2.70	T 60	13.30
T 15	3.30	T 70	15.60
T 20	3.90	T 80	17.60
T 25	4.50	T 90	20.00
T 27	5.00	T 100	22.20
T 30	5.60		

**SOSTITUISCE
SERIE
107-11
KOKEN**

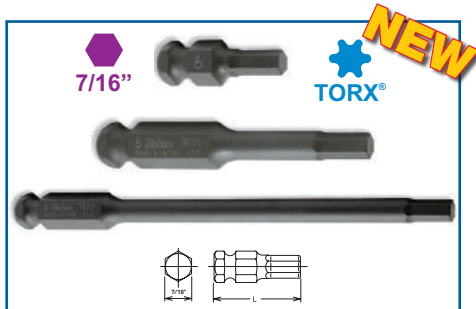

INSERTO CON MASCHIO TORX®

Koken articolo		L mm		Euro
183T-35-T25	TX 25	35	1	8,58
183T-35-T30	TX 30	35	1	8,58
183T-35-T40	TX 40	35	1	8,58
183T-35-T45	TX 45	35	1	8,58
183T-35-T50	TX 50	35	1	8,80
183T-35-T55	TX 55	35	1	8,80
183T-35-T60	TX 60	35	1	14,27
183T-75-T30	TX 30	75	1	9,52
183T-75-T40	TX 40	75	1	9,52
183T-75-T45	TX 45	75	1	9,52
183T-75-T50	TX 50	75	1	9,52
183T-75-T55	TX 55	75	1	9,52
183T-75-T60	TX 60	75	1	16,36
183T-150-T30	TX 30	150	1	14,80
183T-150-T40	TX 40	150	1	14,80
183T-150-T45	TX 45	150	1	14,80
183T-150-T50	TX 50	150	1	14,80
183T-150-T55	TX 55	150	1	14,80

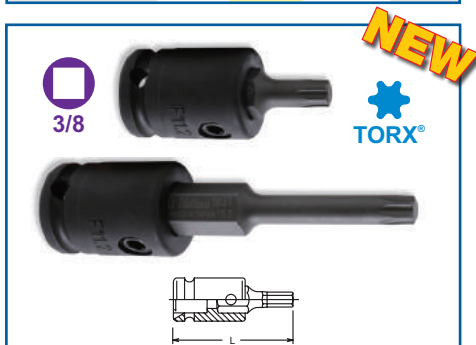

**BUSSOLA MASCHIO ESAGONALE
IN DUE PARTI:
BUSSOLA + INSERTO MASCHIO TORX®**

Koken articolo		L mm		Euro
13134T-52-T30	TX 30	52	1	24,39
13134T-52-T40	TX 40	52	1	24,39
13134T-52-T45	TX 45	52	1	24,39
13134T-52-T50	TX 50	52	1	24,61
13134T-52-T55	TX 55	52	1	24,61
13134T-52-T60	TX 60	52	1	30,42
13134T-92-T30	TX 30	92	1	25,30
13134T-92-T40	TX 40	92	1	25,30
13134T-92-T45	TX 45	92	1	25,30
13134T-92-T50	TX 50	92	1	25,30
13134T-92-T55	TX 55	92	1	25,44
13134T-92-T60	TX 60	92	1	32,51

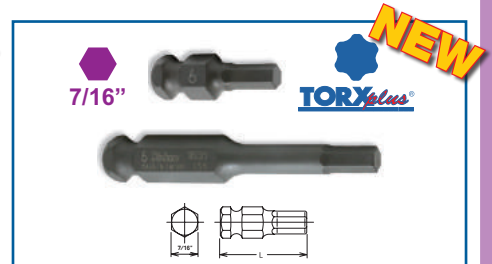

INSERTO CON MASCHIO TORX PLUS®

Koken articolo		L mm		Euro
183T-35-30IP	30IP	35	1	10,04
183T-35-40IP	40IP	35	1	10,04
183T-35-45IP	45IP	35	1	10,04
183T-35-50IP	50IP	35	1	10,45
183T-35-55IP	55IP	35	1	10,45
183T-35-60IP	60IP	35	1	17,60
183T-75-30IP	30IP	75	1	11,85
183T-75-40IP	40IP	75	1	11,85
183T-75-45IP	45IP	75	1	11,85
183T-75-50IP	50IP	75	1	11,85
183T-75-55IP	55IP	75	1	11,85
183T-75-60IP	60IP	75	1	20,10

	S mm	S mm	
8 IP	2.30	30 IP	5.60
9 IP	2.50	40 IP	6.70
10 IP	2.70	45 IP	7.90
15 IP	3.30	50 IP	8.90
20 IP	3.90	55 IP	11.30
25 IP	4.50	60 IP	13.30
27 IP	5.00		

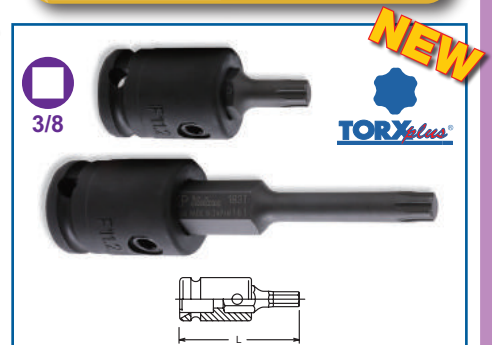



**BUSSOLA MASCHIO ESAGONALE
IN DUE PARTI:
BUSSOLA + INSERTO MASCHIO TORX PLUS®**

Koken articolo		L mm		Euro
13134T-52-30IP	30IP	52	1	25,91
13134T-52-40IP	40IP	52	1	25,91
13134T-52-45IP	45IP	52	1	25,91
13134T-52-50IP	50IP	52	1	26,35
13134T-52-55IP	55IP	52	1	26,35
13134T-52-60IP	60IP	52	1	33,28
13134T-92-30IP	30IP	92	1	27,69
13134T-92-40IP	40IP	92	1	27,69
13134T-92-45IP	45IP	92	1	27,69
13134T-92-50IP	50IP	92	1	27,69
13134T-92-55IP	55IP	92	1	27,69
13134T-92-60IP	60IP	92	1	35,75

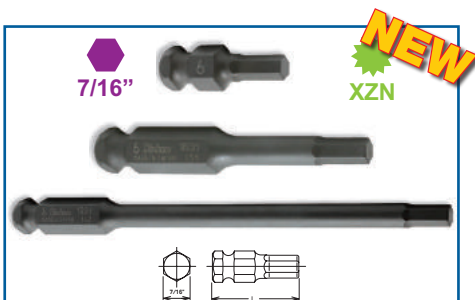
IMPACT 3/8"



INSERTO CON MASCHIO XZN

Koken articolo		L mm		Euro
183X-35-M 4	M 4	35	1	8,83
183X-35-M 5	M 5	35	1	8,83
183X-35-M 6	M 6	35	1	8,83
183X-35-M 8	M 8	35	1	8,83
183X-35-M10	M10	35	1	9,35
183X-35-M12	M12	35	1	13,34
183X-35-M14	M14	35	1	14,27
183X-75-M 4	M 4	75	1	10,45
183X-75-M 5	M 5	75	1	10,45
183X-75-M 6	M 6	75	1	10,45
183X-75-M 8	M 8	75	1	10,45
183X-75-M10	M10	75	1	10,62
183X-75-M12	M12	75	1	15,79
183X-75-M14	M14	75	1	16,89
183X-150-M 5	M 5	150	1	17,19
183X-150-M 6	M 6	150	1	17,19
183X-150-M 8	M 8	150	1	21,42
183X-150-M10	M10	150	1	21,42
183X-150-M12	M12	150	1	26,07

XZN	S mm	S mm
M 4	3,60	M12 11,50
M 5	4,80	M14 13,30
M 6	6,10	M16 15,70
M 8	7,30	M18 16,90
M10	9,70	

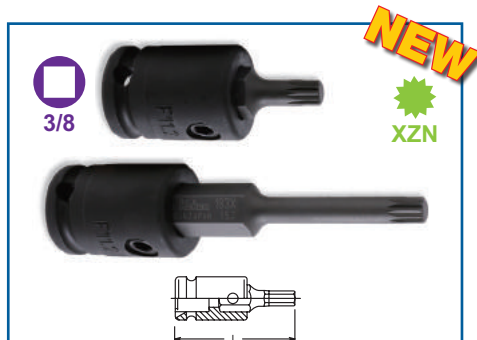

**SOSTITUISCE
SERIE
107-11
KOKEN**



BUSSOLA MASCHIO ESAGONALE

IN DUE PARTI:

BUSSOLA + INSERTO MASCHIO XZN

Koken articolo		L mm		Euro
13134X-52-M5	M 5	52	1	24,97
13134X-52-M6	M 6	52	1	24,97
13134X-52-M8	M 8	52	1	24,97
13134X-52-M10	M10	52	1	25,49
13134X-52-M12	M12	52	1	29,48
13134X-52-M14	M14	52	1	30,42
13134X-92-M5	M 5	92	1	26,59
13134X-92-M6	M 6	92	1	26,59
13134X-92-M8	M 8	92	1	26,59
13134X-92-M10	M10	92	1	26,76
13134X-92-M12	M12	92	1	31,93
13134X-92-M14	M14	92	1	33,03

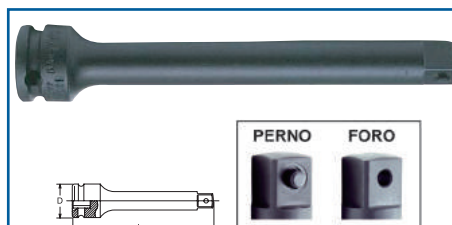

PROLUNGA

Koken articolo	D mm		L mm		Euro
13760-50P	22	PERNO	50	1	17,88
13760-75P	22	PERNO	75	1	17,88
13760-100P	22	PERNO	100	1	19,33
13760-125P	22	PERNO	125	1	19,33
13760-150P	22	PERNO	150	1	22,22
13760-200P	22	PERNO	200	1	25,03
13760-250P	22	PERNO	250	1	25,03
NEW 13760-50	22	FORO	50	1	17,88
NEW 13760-75	22	FORO	75	1	17,88
NEW 13760-100	22	FORO	100	1	19,33
NEW 13760-125	22	FORO	125	1	19,33
NEW 13760-150	22	FORO	150	1	22,22
NEW 13760-200	22	FORO	200	1	25,03
NEW 13760-250	22	FORO	250	1	25,03

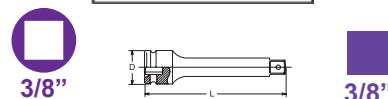
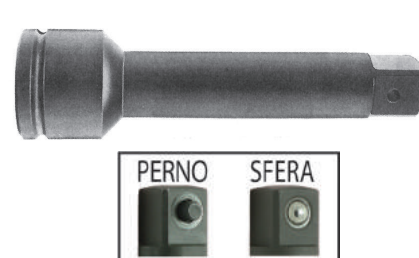

PROLUNGHE PER BUSSOLE
"POWER IMPACT" MASCHIO/FEMMINA

FEIMEC articolo		L mm		Euro
97-3	PERNO	75	1	12,60
97-3-100	PERNO	100	1	12,60
97-3-125	PERNO	125	1	13,65
97-4	PERNO	150	1	14,18
97-4-200	PERNO	200	1	17,85
97-5-250	PERNO	250	1	19,43
97-5-300	PERNO	300	1	24,15
97-3-125 SWF	SGANCIO RAPIDO	125	1	37,80
97-3 S	SFERA	75	1	12,60
97-3-100 S	SFERA	100	1	12,60
97-3-125 S	SFERA	125	1	13,65
97-4 S	SFERA	150	1	14,18
97-4-200 S	SFERA	200	1	17,85
97-5-250 S	SFERA	250	1	19,43

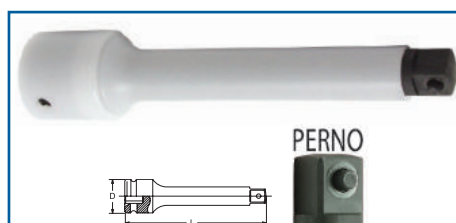

PROLUNGA CON RIVESTIMENTO

Koken articolo	D mm	L mm		Euro
13760-125P.FR	26.2	125	1	119,60
13760-250P.FR	26.2	250	1	156,28



BGS articolo	DESCRIZIONE	Euro
BGS 189	SNODO A MACCHINA	18,00

CARATTERISTICHE

- finitura nera
- con sfera di tenuta



NEW

1/4" 3/8" 1/2" PRO+ CROMO

BGS articolo	DESCRIZIONE	Euro
BGS 9459	SET 3 PEZZI, SNODI	38,00

CARATTERISTICHE

- con scanalatura e foro per spina
- comprende:
 - snodo 1/4" F - 1/4" M
 - snodo 3/8" F - 3/8" M
 - snodo 1/2" F - 1/2" M

MANDRINO CON SGANCIO RAPIDO PER BUSSOLE "POWER IMPACT"
 attacco: Quadro femmina
 impronta: DIN 3126, E 11,2 - E 6,35

articolo	1/4"	3/8"	L mm	1	Euro
195-SWF	1/4"	1/4"	41	1	42,00
196-SWF	3/8"	3/8"	46	1	42,00
97-3-125 SWF	3/8"	3/8"	125	1	37,80
197-SWF	1/2"	1/2"	60	1	46,20
199-SWF	3/4"	3/4"	78	1	114,35
1991-SWF	1"	1"	100	1	131,25

Koken

12222 AL	1/4"	1/4"	35	1	50,44
13333 AL	3/8"	3/8"	45	1	53,05
14444 AL	1/2"	1/2"	55	1	58,27
16666 AL	3/4"	3/4"	75	1	121,94
18888 AL	1"	1"	95	1	178,01

NOTE

SNODO UNIVERSALE

articolo	PERNO	L mm	1	Euro
13771-P	PERNO	48	1	43,53
13771	FORO	48	1	43,53

DOPPIO SNODO

articolo	D mm	L mm	1	Euro
13772-P	22	75	1	66,47

SNODO UNIVERSALE

articolo	PERNO	L mm	1	Euro
13770-P	PERNO	56	1	41,39
13770	FORO	56	1	41,39

IMPACT 3/8"



ESAGONO



CHIAVI A BUSSOLA
GUIDATE ANTI VIBRAZIONI
BOCCA ESAGONALE

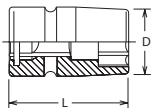

Kokon articolo	mm	D mm	L mm	mm	Euro
NV13400M-8	8	13.3	43	1	30,97
NV13400M-10	10	15.8	43	1	30,97
NV13400M-11	11	17	43	1	30,97
NV13400M-12	12	18.3	43	1	30,97
NV13400M-13	13	19.5	43	1	33,72
NV13400M-14	14	20.8	43	1	33,72
NV13400M-15	15	22	43	1	33,72
NV13400M-16	16	23.3	43	1	33,72
NV13400M-17	17	24.5	43	1	33,72
NV13400M-18	18	25.8	43	1	36,74
NV13400M-19	19	27	43	1	36,74
NV13400M-21	21	29.5	43	1	38,12
NV13400M-22	22	30.8	43	1	38,25



ESAGONO



CHIAVI A BUSSOLA
GUIDATE ANTI
VIBRAZIONI
BOCCA ESAGONALE
EXTRA LUNGHE

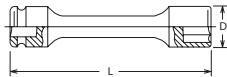

Kokon articolo	mm	D mm	L mm	mm	Euro
NV13145M-100-6	6	13	100	1	43,97
NV13145M-100-8	8	13	100	1	43,97
NV13145M-100-10	10	15.5	100	1	43,97
NV13145M-100-12	12	18	100	1	43,97
NV13145M-100-13	13	19	100	1	44,88
NV13145M-100-14	14	21	100	1	44,88
NV13145M-100-15	15	22	100	1	44,88
NV13145M-100-16	16	24	100	1	44,88
NV13145M-100-17	17	25	100	1	44,88
NV13145M-150-6	6	13	150	1	70,04
NV13145M-150-8	8	13	150	1	70,04
NV13145M-150-10	10	15.5	150	1	70,04
NV13145M-150-12	12	18	150	1	70,04
NV13145M-150-13	13	19	150	1	71,64
NV13145M-150-14	14	21	150	1	71,64
NV13145M-150-15	15	22	150	1	71,64
NV13145M-150-16	16	24	150	1	71,64
NV13145M-150-17	17	25	150	1	71,64
NV13145M-200-6	6	13	200	1	71,20
NV13145M-200-8	8	13	200	1	71,20
NV13145M-200-10	10	15.5	200	1	71,20
NV13145M-200-12	12	18	200	1	71,20
NV13145M-200-13	13	19	200	1	72,57
NV13145M-200-14	14	21	200	1	72,57
NV13145M-200-15	15	22	200	1	72,57
NV13145M-200-16	16	24	200	1	72,57
NV13145M-200-17	17	25	200	1	72,57



PROLUNGA ANTI VIBRAZIONI

Kokon articolo	D mm	L mm	mm	Euro
NV13760-75P	19	75	1	43,01
NV13760-125P	19	125	1	52,03
NV13760-150P	19	150	1	55,39
NV13760-250P	19	250	1	55,39



3/8



ELIMINAZIONE DELLE VIBRAZIONI
LA PROLUNGA DEL MANDRINO CALZA
SULLA PARETE CILINDRICA DELL' ALBERO
DELL' AVVITATORE
ATTENZIONE: CONTROLLARE LA
LUNGHEZZA DELL' ALBERO!

FE/MEC articolo	mm	mm	L mm	mm	Euro
NV 3814	3/8"	1/4" E	52	1	50,40
NV 38716	3/8"	7/16"	55	1	78,75



3/8



7/16"

BUSSOLA
PORTAINSERI
ANTI
VIBRAZIONI
DA 7/16"

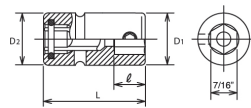

Kokon articolo	D mm	L mm	mm	Euro
NV13134	22	45	1	87,78



3/8





3/8"

MANDRINI ANTIVIBRAZIONE PORTABUSSOLE
E SGANCIO RAPIDO

FE/MEC articolo	mm	mm	L mm	mm	Euro
NV196	3/8"	3/8"	75	1	51,45

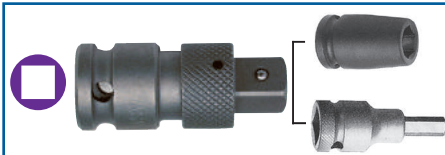
Guidate antivibrazioni



MANDRINO CON SGANCIO RAPIDO PER BUSSOLE "POWER IMPACT"

attacco: Quadro femmina
impronta: DIN 3126, E 11,2 - E 6,35

articolo	F	M	L mm	📦	Euro
195-SWF	1/4"	1/4"	41	1	42,00
196-SWF	3/8"	3/8"	46	1	42,00
197-SWF	1/2"	1/2"	60	1	46,20
199-SWF	3/4"	3/4"	78	1	114,35
1991-SWF	1"	1"	100	1	131,25
Koken					
12222 AL	1/4"	1/4"	35	1	50,44
13333 AL	3/8"	3/8"	45	1	53,05
14444 AL	1/2"	1/2"	55	1	58,27
16666 AL	3/4"	3/4"	75	1	121,94
18888 AL	1"	1"	95	1	178,01

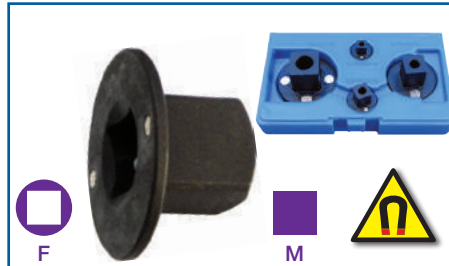

RACCORDI DI RIDUZIONE MAGNETICI "POWER IMPACT" A SCOMPARSA - SPAZI RIDOTTI

articolo	F	M	L mm	📦	Euro
698-00	1/4"	3/8"	17	1	10,00
698-0	1/4"	1/2"	22	1	10,00
698-1	3/8"	1/2"	22	1	10,50
698-11	1/2"	3/4"	30	1	14,70
698-8	3/4"	1"	35	1	21,00
698-13	1"	1 1/2"	50	1	31,50
698-15	1 1/2"	2 1/2"	60	1	210,00
698	CASSETTA 4 PZ. CONTENUTO: 1 PZ. 698-00 1 PZ. 698-1 1 PZ. 698-11 1 PZ. 698-8			1	63,00

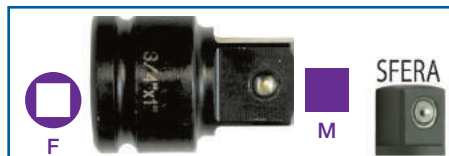

RACCORDI DI RIDUZIONE "POWER IMPACT" MASCHIO/FEMMINA CON SFERA DI TENUTA NEL QUADRO MASCHIO

articolo	F	M	L mm	📦	Euro
696-00 S	1/4"	3/8"	26	1	10,00
696-0 S	3/8"	1/4"	32	1	10,00
696-01 S	1/2"	1/4"	36	1	10,00
696-1 S	3/8"	1/2"	36	1	10,00
696-2 S	1/2"	3/8"	38	1	10,50
696-11 S	1/2"	3/4"	48	1	12,60
696-4 S	3/4"	1/2"	56	1	16,80
696-8 S	3/4"	1"	63	1	22,05
696-9 S	1"	3/4"	75	1	28,35



RACCORDI DI RIDUZIONE "POWER IMPACT" MASCHIO/FEMMINA

articolo	F	M	L mm	📦	Euro
96-00	PERNO 1/4"	3/8"	32	1	12,47
96-0	PERNO 3/8"	1/4"	35	1	12,47
96-1	PERNO 3/8"	1/2"	45	1	12,47
96-01	PERNO 1/2"	1/4"	38	1	13,00
96-2	PERNO 1/2"	3/8"	45	1	13,56
96-3	FORO 5/8"	1/2"	50	1	20,07
96-4	PERNO 3/4"	1/2"	70	1	23,32
96-5	FORO 3/4"	5/8"	70	1	26,58
96-6	FORO 5/8"	3/4"	70	1	20,61
96-7	FORO 1/2"	5/8"	50	1	16,26
96-8	FORO 3/4"	1"	70	1	28,74
96-9	FORO 1"	3/4"	70	1	35,79
96-10	PERNO 1"	1/2"	70	1	65,00
96-11	FORO 1/2"	3/4"	50	1	17,89
96-12	FORO 1 1/2"	1"	115	1	121,80
96-13	FORO 1"	1 1/2"	115	1	51,51
96-14	FORO 2 1/2"	1 1/2"	115	1	379,60
96-15	FORO 1 1/2"	2 1/2"	120	1	260,30
96-16	FORO 1 1/4"	1"	140	1	126,00
96-17	FORO 1 3/4"	1 1/2"	150	1	294,00



articolo	DESCRIZIONE	Euro
BGS 200	SET 6 PEZZI RIDUZIONI A MACCHINA	46,92

CARATTERISTICHE
• rivestimento specifico nero opaco
CONTENUTO
• 1/4" F X 3/8" M, coppia massima 60 Nm
• 3/8" F X 1/4" M, coppia massima 60 Nm
• 3/8" F X 1/2" M, coppia massima 200 Nm
• 1/2" F X 3/8" M, coppia massima 200 Nm
• 1/2" F X 3/4" M, coppia massima 500 Nm
• 3/4" F X 1/2" M, coppia massima 500 Nm

RICAMBI		
BGS 200-LEER	CASSETTA VUOTA	5,46

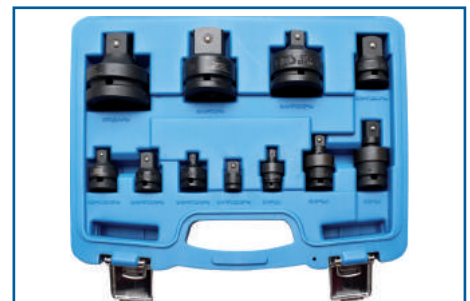

articolo	DESCRIZIONE	Euro
BGS 25140	SET 11 PEZZI RIDUZIONI E SNODI A MACCHINA	113,48

CARATTERISTICHE
• rivestimento specifico nero opaco
CONTENUTO
• 1/4" F x 3/8" M
• 3/8" F x 1/4" M
• 3/8" F x 1/2" M
• 1/2" F x 3/8" M
• 1/2" F x 3/4" M
• 3/4" F x 1/2" M
• 3/4" F x 1" M
• 1" F x 3/4" M
• snodi da 1/4", 3/8", 1/2"

3/8



1/2"

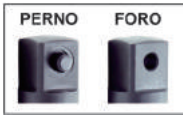

RACCORDO DI RIDUZIONE QUADRO MASCHIO 1/2" E FEMMINA 3/8"

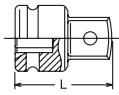

Kokken articolo		L mm		Euro
13344A-P	PERNO	32,5	1	17,77
13344A	FORO	32,5	1	17,77

3/8



1/4"

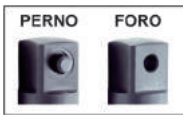

RACCORDO DI RIDUZIONE QUADRO MASCHIO 1/4" E FEMMINA 3/8"

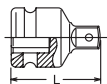

Kokken articolo		L mm		Euro
13322A-P	PERNO	25	1	16,75
13322A	FORO	25	1	16,75

F



M

RACCORDI DI RIDUZIONE A MANDRINO CON SGANCIO RAPIDO "POWER IMPACT"

articolo	F	M	L mm		Euro
691-0 SWF	3/8"	1/4"	55	1	31,50
691-1 SWF	3/8"	1/2"	60	1	31,50
691-2 SWF	1/2"	3/8"	55	1	36,75
691-11 SWF	1/2"	3/4"	75	1	42,00
691-4 SWF	3/4"	1/2"	70	1	42,00
691-9 SWF	1"	3/4"	90	1	73,50



SPINE ACCIAIO PER BUSSOLE

Kokken articolo		L mm		Euro
1200 A	1/4"	10,2	1	0,44
1301 A	3/8"	14,5	1	0,44
1302 A	3/8"	17,5	1	0,44
1401 A	1/2"	20	1	0,74
1402 A	1/2"	25	1	0,74
1500 A	5/8"	30	1	0,74
1601 A	3/4"	35	1	0,83
1602 A	3/4"	45	1	0,94
1801 A	1"	45	1	0,94
1802 A	1"	75	1	1,82
1701 A	1 1/2"	75	1	1,98
1702 A	1 1/2"	110	1	3,99
1901 A	2 1/2"	110	1	4,46
1902 A	2 1/2"	155	1	5,06
2001 A	3 1/2"	155	1	8,36
2002 A	3 1/2"	180	1	6,90

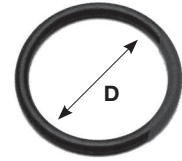

ANELLI DI GOMMA PER BUSSOLE

Kokken articolo		D mm		Euro
1200 B	1/4"	9	1	0,72
1301 B	3/8"	13	1	0,83
1302 B	3/8"	16	1	0,88
1401 B	1/2"	19	1	1,02
1402 B	1/2"	24	1	1,10
1500 B	5/8"	28	1	1,35
1601 B	3/4"	36	1	1,46
1602 B	3/4"	45	1	2,15
1801 B	1"	45	1	1,98
1802 B	1"	75	1	8,72
1701 B	1 1/2"	75	1	8,58
1702 B	1 1/2"	114	1	21,42
1901 B	2 1/2"	114	1	22,25
1902 B	2 1/2"	158	1	27,72
2001 B	3 1/2"	158	1	82,80
2002 B	3 1/2"	183	1	91,88



ESTRATTORE PER MOLLE DI SICUREZZA

Kokken articolo				Euro
149	3/8" - 1/2"	1		1,57
152	3/4" - 1"	1		1,68

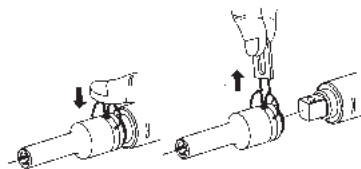
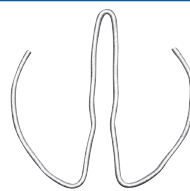

MOLLA DI SICUREZZA PER BUSSOLE

Kokken articolo		Ø		Euro
1301C	3/8"	≤12	1	0,94
1302C	3/8"	>12	1	0,94
1401C	1/2"	≤14	1	1,18
1402C	1/2"	>14	1	1,18
1600C	3/4"	≤46	1	2,26
1801C	1"	≤70	1	2,23
1802C	1"	>70	1	7,87
1700C	1 1/2"	≤90	1	8,22

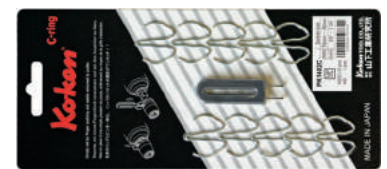

SET MOLLE DI SICUREZZA PER BUSSOLE

Kokken articolo	nr.			Euro
PK1301 C-10	10	149	1	13,92
PK1302 C-10	10	149	1	13,92
PK1401 C-10	10	149	1	16,86
PK1402 C-10	10	149	1	16,86
PK1600 C-10	10	149	1	25,82
PK1801 C-10	10	149	1	26,32

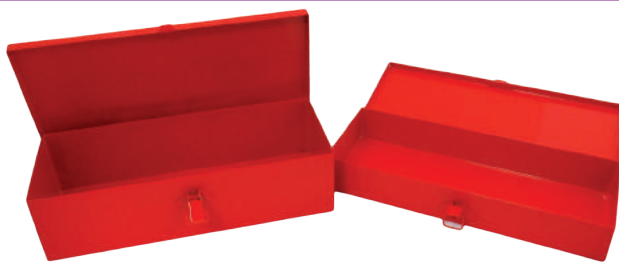

CASSETTE METALLICHE PORTA-BUSSOLE

FERMEC articolo	Dimensioni (lunghezza x larghezza x altezza) mm		Euro
CASS-2510	280 x 100 x 40 mm	1	26,25
CASS-3112	310 x 120 x 80 mm	1	39,90
CASS-3211	320 x 115 x 50 mm	1	42,00
CASS-6213	610 x 130 x 85 mm	1	55,00

NOTE

- a richiesta assortimento di bussole a macchina in cassetta metallica

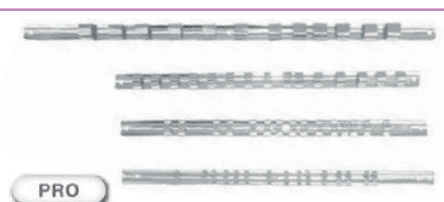

GUIDE PORTA BUSSOLE CON CLIP

BG articolo	Numero Clip	Euro
BGS 2316 1/4"	7	2,93
BGS 2317 3/8"	7	3,19
BGS 2318 1/2"	7	3,32
BGS 2120 1/4"	15	4,08
BGS 2330 3/8"	15	4,59
BGS 2540 1/2"	15	4,46
BGS 3460 3/4"	12	8,93

CARATTERISTICHE

- cromato satinato



GUIDE PORTA BUSSOLE PER MOLLE IN ACCIAIO DA 1/4" - 3/8" - 1/2" - 3/4"

Kokon articolo	L mm		Euro
R 158	158	1	2,52
R 251	251	1	2,56
R 300	300	1	2,62
R 400	400	1	2,71



MOLLE IN ACCIAIO PER GUIDE

Kokon articolo	Euro
C 14 1/4"	0,34
C 38 3/8"	0,34
C 12 1/2"	0,34
C 34 3/4"	0,50

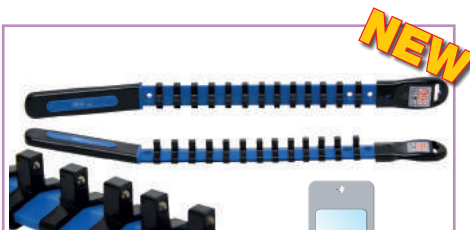

GUIDE PORTA BUSSOLE CON CLIP

BG articolo	Numero Clip	Euro
BGS 9193 1/4"	13	3,83
BGS 9194 3/8"	11	4,08
BGS 9195 1/2"	9	4,34

CARATTERISTICHE

- clip con sfere di tenuta



GUIDE MAGNETICHE PORTA BUSSOLE CON CLIP

BG articolo	Numero Clip	L mm	Euro
BGS 9342 1/4"	12	310	22,19
BGS 9343 3/8"	12	310	22,44
BGS 9344 1/2"	12	310	22,70

CARATTERISTICHE

- clip con sfera per bussole realizzate in plastica rinforzata
- magneti rivestiti in gomma protettiva



GUIDE MAGNETICHE PORTA BUSSOLE CON CLIP



Kokon articolo	Nr. Clip	L mm		Euro
RSAL200-1/4x12	12	200	1	37,68
RSAL200-3/8x8	8	200	1	35,56
RSAL300-3/8x12	12	300	1	42,90
RSAL300-1/2x10	10	300	1	44,85



GUIDE PORTA BUSSOLE MAGNETICHE PER MOLLE IN PLASTICA

Kokon articolo	L mm		Euro
RSAL-200	200	1	31,54
RSAL-300	300	1	36,63



MOLLE IN PLASTICA PER GUIDE

Koken articolo			Euro
CLIP-1/4	1/4"	1	0,55
CLIP-3/8	3/8"	1	0,55
CLIP-1/2	1/2"	1	0,55

**GUIDA MAGNETICA PER MOLLE PORTA
BUSSOLE DA 1/4" - 3/8" - 1/2" - 3/4"**

FERMEC articolo	L mm		Euro
MAG300	300	1	20,50

BARRA PORTABUSSOLE MAGNETICA,

BGS articolo		Numero vani	Euro
BGS 3011-1	1/4"	10	5,36
BGS 3011-2	3/8"	12	8,16
BGS 3011-3	1/2"	10	11,09

CARATTERISTICHE

- le bussole sono trattenute grazie ad una banda magnetica



1/4" 3/8" 1/2" 3/4" 1"

CLIP X ATTACCO QUADRO FEMMINA

BGS articolo		Euro
BGS HANGER-1	1/4"	1,91
BGS HANGER-2	3/8"	1,91
BGS HANGER-3	1/2"	1,91
BGS HANGER-4	3/4"	2,04
BGS HANGER-5	1"	2,04

CARATTERISTICHE

- clip in plastica con quadro maschio
- ad esempio per esposizione bussole

NOTE



**CHIAVI A BUSSOLA A
MANO BOCCA ESAGONALE**

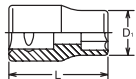

Koken articolo	mm	D ₁ mm	L mm		Euro
4401M-8	8	13.2	36	1	5,80
4401M-9	9	13.8	37	1	5,80
4401M-10	10	15.3	37	1	5,80
4401M-11	11	16.5	37	1	5,80
4401M-12	12	17.8	37	1	5,80
4401M-13	13	19	37	1	5,80
4401M-14	14	20.3	37	1	6,27
4401M-15	15	21.5	37	1	6,27
4401M-16	16	22.8	37	1	6,27
4401M-17	17	24	37	1	6,27
4401M-18	18	25	37	1	6,33
4401M-19	19	26.5	38	1	6,33
4401M-20	20	27.8	38	1	7,21
4401M-21	21	29	38	1	7,21
4401M-22	22	30	40	1	7,21
4401M-23	23	31.5	40	1	7,67
4401M-24	24	32.8	42	1	7,73
4401M-25	25	34	42	1	9,68
4401M-26	26	35	42	1	9,68
4401M-27	27	36.5	43	1	9,68
4401M-28	28	37.8	43	1	11,44
4401M-29	29	39	43	1	11,55
4401M-30	30	40	46	1	12,43
4401M-31	31	41.5	46	1	12,43
4401M-32	32	42.8	46	1	12,43
4400M-33	33	44.2	47	1	18,56
4400M-34	34	45.2	47	1	18,87
4400M-35	35	46.2	47	1	19,61
4400M-36	36	47.2	47	1	19,86
4400M-37	37	48.3	47	1	26,13
4400M-38	38	49.2	47	1	26,13
4400M-41	41	53.1	47	1	47,77
4400M-46	46	59.1	47	1	47,77



**CHIAVI A BUSSOLA A
MANO BOCCA POLIGONALE**

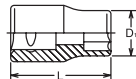

Koken articolo	mm	D ₁ mm	L mm		Euro
4406M-8	8	13.2	36	1	5,80
4406M-9	9	13.8	37	1	5,80
4406M-10	10	15.3	37	1	5,80
4406M-11	11	16.5	37	1	5,80
4406M-12	12	17.8	37	1	5,80
4406M-13	13	19	37	1	5,80
4406M-14	14	20.3	37	1	6,27
4406M-15	15	21.5	37	1	6,27
4406M-16	16	22.8	37	1	6,27
4406M-17	17	24	37	1	6,27
4406M-18	18	25	37	1	6,33
4406M-19	19	26.5	38	1	6,33
4406M-20	20	27.8	38	1	7,21
4406M-21	21	29	38	1	7,21
4406M-22	22	30	40	1	7,21
4406M-23	23	31.5	40	1	7,67
4406M-24	24	32.8	42	1	8,00
4406M-25	25	34	42	1	9,68
4406M-26	26	35	42	1	9,68
4406M-27	27	36.5	43	1	9,68
4406M-28	28	37.8	43	1	11,44
4406M-29	29	39	43	1	11,55
4406M-30	30	40	46	1	12,43
4406M-31	31	41.5	46	1	12,43
4406M-32	32	42.8	46	1	12,43
4405M-33	33	44.2	47	1	18,56
4405M-34	34	45.2	47	1	18,87
4405M-35	35	46.2	47	1	19,61
4405M-36	36	47.2	47	1	19,86
4405M-37	37	48.3	47	1	26,13
4405M-38	38	49.2	47	1	26,13
4405M-41	41	53.1	47	1	47,77
4405M-46	46	59.1	47	1	47,77

POLLICI



**CHIAVI A BUSSOLA A
MANO BOCCA ESAGONALE**

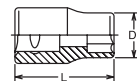

Koken articolo	pollici	D ₁ mm	L mm		Euro
NEW 4400A-1/4	1/4"	10.7	36	1	6,16
4400A-5/16	5/16"	13.2	36	1	6,27
4400A-3/8	3/8"	14.6	37	1	6,27
4400A-7/16	7/16"	16.5	37	1	6,27
4400A-1/2	1/2"	19	37	1	6,27
4400A-9/16	9/16"	20.3	37	1	6,77
4400A-19/32	19/32"	21.5	37	1	6,77
4400A-5/8	5/8"	22.8	37	1	6,77
4400A-21/32	21/32"	24	37	1	6,77
4400A-11/16	11/16"	25	37	1	6,82
4400A-3/4	3/4"	26.5	38	1	6,82
4400A-25/32	25/32"	27.8	38	1	7,73
4400A-13/16	13/16"	29	38	1	7,73
4400A-7/8	7/8"	30	40	1	7,73
4400A-15/16	15/16"	32.8	42	1	8,33
4400A-31/32	31/32"	34	42	1	10,40
4400A-1	1"	35	42	1	10,40
4400A-1-1/16	1-1/16"	36.5	43	1	10,40
4400A-1-1/8	1-1/8"	39	43	1	12,43
4400A-1-3/16	1-3/16"	40	46	1	13,42
4400A-1-1/4	1-1/4"	42.8	46	1	13,42
4400A-1-5/16	1-5/16"	44.2	47	1	19,99
4400A-1-3/8	1-3/8"	46.2	47	1	21,12
4400A-1-7/16	1-7/16"	47.2	47	1	28,16
4400A-1-1/2	1-1/2"	49.2	47	1	28,16



NEW



FENEC
articolo

DESCRIZIONE

Euro

FM 31032

**SET 6 PEZZI, INSERTI
ANTI-GRAFFIO PER
CHIAVI A BUSSOLA
ESAGONALI**

8,00

CARATTERISTICHE

- inserti speciali che, utilizzati all'interno delle bussole esagonali tradizionali, consentono di prevenire danni a parti cromate o verniciate o, più in generale, con trattamenti superficiali
- comprende:
 - inserto 8 mm, per bussola 12 mm, coppia 9 Nm
 - inserto 10 mm, per bussola 14 mm, coppia 17 Nm
 - inserto 12 mm, per bussola 16 mm, coppia 27 Nm
 - inserto 13 mm, per bussola 17 mm, coppia 45 Nm
 - inserto 15 mm, per bussola 19 mm, coppia 50 Nm
 - inserto 17 mm, per bussola 22 mm, coppia 79 Nm
- per uso con bussole esagonali metriche





POLLICI

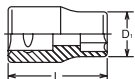

POLIGONALE

**CHIAVI A BUSSOLA A
MANO BOCCA POLIGONALE**



NEW

Koken articolo	 pollici	D ₁ mm	L mm		Euro
4405A-1/4	1/4"	13.2	36	1	6,16
4405A-5/16	5/16"	13.2	36	1	6,27
4405A-3/8	3/8"	14.6	37	1	6,27
4405A-7/16	7/16"	16.5	37	1	6,27
4405A-1/2	1/2"	19	37	1	6,27
4405A-9/16	9/16"	20.3	37	1	6,77
4405A-19/32	19/32"	21.5	37	1	6,77
4405A-5/8	5/8"	22.8	37	1	6,77
4405A-21/32	21/32"	24	37	1	6,77
4405A-11/16	11/16"	25	37	1	6,82
4405A-3/4	3/4"	26.5	38	1	6,82
4405A-25/32	25/32"	27.8	38	1	7,73
4405A-13/16	13/16"	29	38	1	7,73
4405A-7/8	7/8"	30	40	1	7,73
4405A-15/16	15/16"	32.8	42	1	8,33
4405A-31/32	31/32"	34	42	1	10,40
4405A-1	1"	35	42	1	10,40
4405A-1-1/16	1-1/16"	36.5	43	1	10,40
4405A-1-1/8	1-1/8"	39	43	1	12,43
4405A-1-3/16	1-3/16"	40	46	1	13,42
4405A-1-1/4	1-1/4"	42.8	46	1	13,42
4405A-1-5/16	1-5/16"	44.2	47	1	19,99
4405A-1-3/8	1-3/8"	46.2	47	1	21,12
4405A-1-7/16	1-7/16"	47.2	47	1	28,16
4405A-1-1/2	1-1/2"	49.2	47	1	28,16

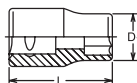

SURFACE
DRIVE

**CHIAVI A BUSSOLA A
MANO BOCCA
SURFACE DRIVE**

Koken articolo	 mm	D ₁ mm	L mm		Euro
4410M-8	8	13.2	36	1	6,11
4410M-9	9	13.8	37	1	6,11
4410M-10	10	15.3	37	1	6,11
4410M-11	11	16.5	37	1	6,11
4410M-12	12	17.8	37	1	6,11
4410M-13	13	19	37	1	6,11
4410M-14	14	20.3	37	1	6,57
4410M-15	15	21.5	37	1	6,57
4410M-16	16	22.8	37	1	6,57
4410M-17	17	24	37	1	6,57
4410M-18	18	25	37	1	6,63
4410M-19	19	26.5	38	1	6,63
4410M-20	20	27.8	38	1	7,54
4410M-21	21	29	38	1	7,54
4410M-22	22	30	40	1	7,54
4410M-23	23	31.5	40	1	8,11
4410M-24	24	32.8	42	1	8,11
4410M-25	25	34	42	1	10,15
4410M-26	26	35	42	1	10,15
4410M-27	27	36.5	43	1	10,15
4410M-28	28	37.8	43	1	12,02
4410M-29	29	39	43	1	12,13
4410M-30	30	40	46	1	13,06
4410M-31	31	41.5	46	1	13,06
4410M-32	32	42.8	46	1	13,06
4410M-34	34	45.2	47	1	19,80



NEW





1/2"

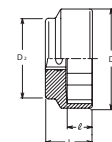

POLIGONALE

**CHIAVI A BUSSOLA A
MANO BOCCA POLIGONALE
EXTRA CORTE PER DADO
ASSE POSTERIORE MOTO**



Koken articolo	 mm	D ₁ mm	L mm		Euro
4405M-DU-36	36	47.3	28	1	59,46
4405M-DU-55	55	71	31	1	75,87

NEW

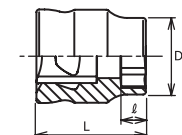

ESAGONO

**CHIAVI A BUSSOLA
BOCCA ESAGONALE
EXTRA CORTE**

Koken articolo	 mm	D ₁ mm	L mm		Euro
4400MZ-8	8	12.6	26	1	8,17
4400MZ-10	10	15	26	1	8,17
4400MZ-12	12	17.5	27	1	8,17
4400MZ-13	13	18.7	28	1	8,17
4400MZ-14	14	19.8	28	1	8,31
4400MZ-16	16	22.3	28	1	8,64
4400MZ-17	17	23.6	29	1	8,64
4400MZ-18	18	24.8	29	1	9,30
4400MZ-19	19	26	29	1	9,30
4400MZ-21	21	28.4	29	1	12,84
4400MZ-22	22	29.6	29	1	12,84
4400MZ-24	24	32	29	1	14,80
4400MZ-27	27	35.7	30	1	16,47
4400MZ-30	30	39.3	31	1	17,55
4400MZ-32	32	41.7	32	1	18,98



NEW



1/2"

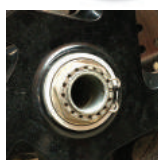
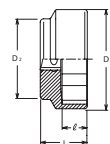

ESAGONO

**CHIAVI A BUSSOLA A
MANO BOCCA ESAGONALE
EXTRA CORTE PER DADO
CENTRALE CATENA-RUOTA**

Koken articolo	 mm	D ₁ mm	L mm		Euro
4400M-DU-41	41	53	28	1	69,80
4400M-DU-46	46	59	28	1	73,62





OTTAGONALE OTTO ANGOLI

CHIAVI A BUSSOLA A MANO BOCCA OTTAGONALE

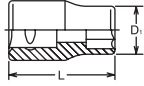

Koken articolo	mm	D ₁ mm	L mm		Euro
4109M-14	14	26	38	1	9,68
4109M-17	17	28	40	1	9,68
4109M-19	19	29	40	1	11,28
4109M-21.5	21.5	32	40	1	11,55
4109M-23	23	34	43	1	14,69



TORXplus

CHIAVI A BUSSOLA BOCCA TORX PLUS®

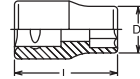

Koken articolo		D ₁	L mm		Euro
4425-10EPL	10EPL	13.2	36	1	15,59
4425-12EPL	12EPL	14.6	37	1	15,59
4425-14EPL	14EPL	16.5	37	1	15,59
4425-16EPL	16EPL	19.0	37	1	15,59
4425-18EPL	18EPL	20.3	37	1	15,59
4425-20EPL	20EPL	22.9	37	1	16,47



NUT GRIP® BLOCCADADI

CHIAVI A BUSSOLA A MANO BOCCA NUT GRIP®

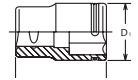

Koken articolo	mm	D ₁ mm	L mm		Euro
4450M-10	10	15.3	36	1	9,82
4450M-11	11	16.5	36	1	9,82
4450M-12	12	17.8	36	1	9,82
4450M-13	13	19	36	1	10,15
4450M-14	14	20.3	36	1	10,15
4450M-15	15	21.5	36	1	10,20
4450M-16	16	22.8	36	1	10,20
4450M-17	17	24	36	1	10,20
4450M-18	18	25	36	1	10,29
4450M-19	19	26.5	36	1	10,29
4450M-21	21	29	37	1	10,86
4450M-22	22	30	37	1	10,86
4450M-24	24	32.8	39	1	11,85
4450M-27	27	36.5	40	1	13,64



TORX®

CHIAVI A BUSSOLA A MANO BOCCA TORX®

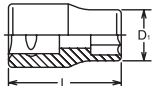

Koken articolo		D ₁ mm	L mm		Euro
4425-E8	E 8	10.7	36	1	6,57
4425-E10	E10	13.2	36	1	6,49
4425-E11	E11	13.8	37	1	6,49
4425-E12	E12	14.6	37	1	6,49
4425-E14	E14	16.5	37	1	6,49
4425-E16	E16	19	37	1	6,49
4425-E18	E18	20.3	37	1	6,49
4425-E20	E20	22.8	37	1	7,21
4425-E22	E22	25	37	1	9,16
4425-E24	E24	26.5	40	1	10,56

TORX PLUS®

S mm S mm

E 4	3.70	E 16	14.60
E 5	4.60	E 18	16.50
E 6	5.60	E 20	18.30
E 7	6.10	E 22	20.10
E 8	7.40	E 24	22.00
E 10	9.30	E 26	23.70
E 11	9.90	E 28	25.50
E 12	11.00	E 30	27.30
E 14	12.80	E 32	29.00



SYSTEM 6

CHIAVI A BUSSOLA A MANO BOCCA SYSTEM 6

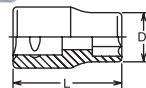

Koken articolo		D mm	L mm		Euro
4400LH-6S	6S	17.3	36	1	9,24
4400LH-8S	8S	17.3	37	1	9,24
4400LH-10S	10S	17.3	37	1	9,24
4400LH-12S	12S	17.3	37	1	9,79
4400LH-14S	14S	17.3	37	1	10,51
4400LH-16S	16S	17	38	1	12,05

TORX®

S mm S mm

E 4	3.70	E 16	14.60
E 5	4.60	E 18	16.50
E 6	5.60	E 20	18.30
E 7	6.10	E 22	20.10
E 8	7.40	E 24	22.00
E 10	9.30	E 26	23.70
E 11	9.90	E 28	25.50
E 12	11.00	E 30	27.30
E 14	12.80	E 32	29.00



LHSTIX®

d mm D mm

LH 3 S	3.80	4.70
LH 4 S	4.50	6.00
LH 5 S	5.60	7.50
LH 6 S	6.80	9.00
LH 7 S	7.90	10.50
LH 8 S	9.00	12.00
LH 10 S	11.30	15.00
LH 12 S	13.60	18.00
LH 14 S	15.80	21.00
LH 16 S	18.10	24.00



SERIE 10 PZ. CHIAVI A BUSSOLA MISURE: 10, 11, 12, 13, 14, 15, 16, 17, 18, 19 MM

Koken articolo			Euro
RS4401M/10		1	58,74
RS4406M/10		1	58,74
RS4410M/10		1	62,04

POLLICI



SERIE 10 PZ. CHIAVI A BUSSOLA BOCCA ESAGONALE MISURE: 3/8", 7/16", 1/2", 9/16", 5/8", 11/16", 3/4", 13/16", 7/8", 15/16"

Koken articolo			Euro
RS4400A/10		1	67,40
RS4405A/10		1	67,40

SERIE 7 PZ. CHIAVI A BUSSOLA BOCCA TORX®

Koken articolo	TORX®	1	Euro
RS4425/7	E10, E12, E14, E16, E18, E20, E24	1	48,92

SERIE 14 PZ. CHIAVI A BUSSOLA BOCCA TORX®

Koken articolo	TORX®	1	Euro
RSX425/14	SERIE 14 PZ.	1	73,98

CARATTERISTICHE

1/4"	E4, E5, E6, E7, E8
3/8"	E10, E11, E12, E14
1/2"	E16, E18, E20, E22, E24

SYSTEM 6 RIBE
SERIE 6 PZ. CHIAVI A BUSSOLA BOCCA SYSTEM 6

Koken articolo	SYSTEM 6 RIBE	1	Euro
RS4400LH/6	6S, 8S, 10S, 12S, 14S, 16S	1	56,54

SERIE 6 PZ. CHIAVI A BUSSOLA BOCCA TORX PLUS®

Koken articolo	TORX PLUS®	1	Euro
RS4425/6-EPL	10EPL, 12EPL, 14EPL, 16EPL, 18EPL, 20EPL	1	90,81

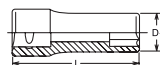
CHIAVI A BUSSOLA A MANO BOCCA ESAGONALE LUNGHE

Koken articolo	mm	D ₁ mm	L mm	1	Euro
4300M-8	8	13.2	77	1	12,73
4300M-9	9	13.8	77	1	12,73
4300M-10	10	15.3	77	1	12,73
4300M-11	11	16.5	77	1	12,73
4300M-12	12	17.8	77	1	12,73
4300M-13	13	19	77	1	12,73
4300M-14	14	20.3	77	1	12,73
4300M-15	15	21.5	77	1	12,95
4300M-16	16	22.8	77	1	13,26
4300M-17	17	24	77	1	13,26
4300M-18	18	25	77	1	13,92
4300M-19	19	26.5	77	1	13,92
4300M-20	20	27.8	77	1	15,15
4300M-21	21	29	77	1	16,31
4300M-22	22	30	77	1	16,31
4300M-23	23	31.5	77	1	17,55
4300M-24	24	32.8	77	1	18,48
4300M-25	25	34	77	1	19,80
4300M-26	26	35	77	1	19,80
4300M-27	27	36.5	77	1	19,80
4300M-28	28	37.8	77	1	22,99
4300M-29	29	39	77	1	24,09
4300M-30	30	40	77	1	24,09
4300M-31	31	41.5	77	1	24,09
4300M-32	32	42.8	77	1	24,09
4300M-33	33	44.2	77	1	40,78
4300M-34	34	45.2	77	1	42,19
4300M-35	35	46.2	77	1	42,19
4300M-36	36	47.2	77	1	43,01
4300M-37	37	48.2	77	1	44,19
4300M-38	38	49	77	1	47,55

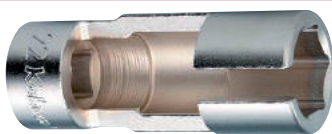
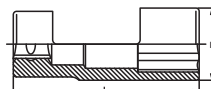
CHIAVI A BUSSOLA A MANO BOCCA ESAGONALE PER SONDE LAMBDA

Koken articolo	mm	D mm	L mm	1	Euro
SP4300M-85	22	33	85	1	46,20
SP4300M-110	22	33	110	1	52,72

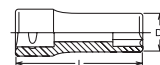
CHIAVI A BUSSOLA A MANO BOCCA POLIGONALE LUNGHE

Koken articolo	mm	D ₁ mm	L mm	1	Euro
4305M-8	8	13.2	77	1	12,73
4305M-9	9	13.8	77	1	12,73
4305M-10	10	15.3	77	1	12,73
4305M-11	11	16.5	77	1	12,73
4305M-12	12	17.8	77	1	12,73
4305M-13	13	19	77	1	12,73
4305M-14	14	20.3	77	1	12,73
4305M-15	15	21.5	77	1	12,95
4305M-16	16	22.8	77	1	13,26
4305M-17	17	24	77	1	13,26
4305M-18	18	25	77	1	13,92
4305M-19	19	26.5	77	1	13,92
4305M-20	20	27.8	77	1	15,15
4305M-21	21	29	77	1	16,31
4305M-22	22	30	77	1	16,31
4305M-23	23	31.5	77	1	17,55
4305M-24	24	32.8	77	1	18,48
4305M-25	25	34	77	1	19,80
4305M-26	26	35	77	1	19,80
4305M-27	27	36.5	77	1	19,80
4305M-28	28	37.8	77	1	22,99
4305M-29	29	39	77	1	24,09
4305M-30	30	40	77	1	24,09
4305M-31	31	41.5	77	1	24,09
4305M-32	32	42.8	77	1	24,09
4305M-33	33	44.2	77	1	40,78
4305M-34	34	45.2	77	1	42,19
4305M-35	35	46.2	77	1	42,19
4305M-36	36	47.2	77	1	43,01
4305M-37	37	48.2	77	1	44,19
4305M-38	38	49	77	1	47,55

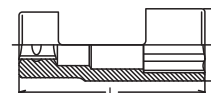
CHIAVI A BUSSOLA A MANO BOCCA POLIGONALE PER INIETTORI MOTORI DIESEL

Koken articolo	mm	D mm	L mm	1	Euro
SP4305M-77	27	36,5	77	1	32,45



POLLICI



CHIAVI A BUSSOLA A MANO BOCCA ESAGONALE LUNGHE

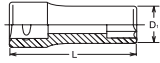

Koken articolo	pollici	D ₁ mm	L mm		€uro
4300A-5/16	5/16"	13.2	77	1	13,72
4300A-3/8	3/8"	14.6	77	1	13,72
4300A-7/16	7/16"	16.5	77	1	13,72
4300A-1/2	1/2"	19	77	1	13,72
4300A-9/16	9/16"	20.3	77	1	13,72
4300A-19/32	19/32"	21.5	77	1	14,00
4300A-5/8	5/8"	22.8	77	1	14,27
4300A-21/32	21/32"	24	77	1	14,27
4300A-11/16	11/16"	25	77	1	15,02
4300A-3/4	3/4"	26.5	77	1	15,02
4300A-25/32	25/32"	27.8	77	1	16,31
4300A-13/16	13/16"	29	77	1	17,57
4300A-7/8	7/8"	30	77	1	17,57
4300A-15/16	15/16"	32.8	77	1	19,91
4300A-31/32	31/32"	34	77	1	21,29
4300A-1	1"	34	77	1	21,29
4300A-1-1/16	1-1/16"	36.5	77	1	21,29
4300A-1-1/8	1-1/8"	37.8	77	1	25,93
4300A-1-3/16	1-3/16"	40	77	1	25,93
4300A-1-1/4	1-1/4"	42.8	77	1	25,93
4300A-1-5/16	1-5/16"	44.2	77	1	43,97
4300A-1-3/8	1-3/8"	46.2	77	1	45,46
4300A-1-7/16	1-7/16"	48	77	1	47,69
4300A-1-1/2	1-1/2"	49	77	1	51,26
4300A-1-13/16	1-13/16"	59	77	1	69,03

POLLICI



CHIAVI A BUSSOLA A MANO BOCCA POLIGONALE LUNGHE

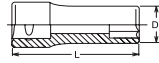

Koken articolo	mm	D ₁ mm	L mm		€uro
4305A-5/16	5/16"	13.2	77	1	13,72
4305A-3/8	3/8"	14.6	77	1	13,72
4305A-7/16	7/16"	16.5	77	1	13,72
4305A-1/2	1/2"	19	77	1	13,72
4305A-9/16	9/16"	20.3	77	1	13,72
4305A-19/32	19/32"	21.5	77	1	14,00
4305A-5/8	5/8"	22.8	77	1	14,27
4305A-21/32	21/32"	24	77	1	14,27
4305A-11/16	11/16"	25	77	1	15,02
4305A-3/4	3/4"	26.5	77	1	15,02
4305A-25/32	25/32"	27.8	77	1	16,31
4305A-13/16	13/16"	29	77	1	17,57
4305A-7/8	7/8"	30	77	1	17,57
4305A-15/16	1-15/16"	32.8	77	1	19,91
4305A-31/32	1-31/32"	34	77	1	21,29
4305A-1	1"	32.8	77	1	21,29
4305A-1-1/16	1-1/16"	36.5	77	1	21,29
4305A-1-1/8	1-1/8"	37.8	77	1	25,93
4305A-1-3/16	1-3/16"	40	77	1	25,93
4305A-1-1/4	1-1/4"	42.8	77	1	25,93
4305A-1-5/16	1-5/16"	44.2	77	1	43,97
4305A-1-3/8	1-3/8"	46.2	77	1	45,46
4305A-1-7/16	1-7/16"	48	77	1	47,69
4305A-1-1/2	1-1/2"	49	77	1	51,26
4305A-1-13/16	1-13/16"	59	77	1	69,03



CHIAVI A BUSSOLA A MANO BOCCA SURFACE DRIVE LUNGHE

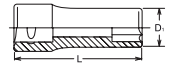

Koken articolo	mm	D mm	L mm		€uro
4310M-8	8	13.2	77	1	13,37
4310M-9	9	13.8	77	1	13,37
4310M-10	10	15.3	77	1	13,37
4310M-11	11	16.5	77	1	13,37
4310M-12	12	17.8	77	1	13,37
4310M-13	13	19	77	1	13,37
4310M-14	14	20.3	77	1	13,37
4310M-15	15	21.5	77	1	13,64
4310M-16	16	22.8	77	1	13,92
4310M-17	17	24	77	1	13,92
4310M-18	18	25	77	1	14,63
4310M-19	19	26.5	77	1	14,63
4310M-20	20	27.8	77	1	15,90
4310M-21	21	29	77	1	17,13
4310M-22	22	30	77	1	17,13
4310M-23	23	31.5	77	1	18,45
4310M-24	24	32.8	77	1	19,42
4310M-25	25	34	77	1	20,74
4310M-26	26	35	77	1	20,74
4310M-27	27	36.5	77	1	20,74
4310M-28	28	37.8	77	1	24,15
4310M-29	29	39	77	1	25,27
4310M-30	30	40	77	1	25,27
4310M-31	31	41.5	77	1	25,27
4310M-32	32	42.8	77	1	25,27
4310M-34	34	45.2	77	1	44,30



TORX®	S mm	S mm	
E 4	3.70	E 16	14.60
E 5	4.60	E 18	16.50
E 6	5.60	E 20	18.30
E 7	6.10	E 22	20.10
E 8	7.40	E 24	22.00
E 10	9.30	E 26	23.70
E 11	9.90	E 28	25.50
E 12	11.00	E 30	27.30
E 14	12.80	E 32	29.00



CHIAVI A BUSSOLA A MANO BOCCA TORX® LUNGHE

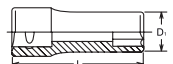

Koken articolo		D mm	L mm		€uro
4325-E 8	E 8	10.7	77	1	15,32
4325-E10	E10	13.2	77	1	15,32
4325-E11	E11	13.8	77	1	15,32
4325-E12	E12	14.6	77	1	15,32
4325-E14	E14	16.5	77	1	15,70
4325-E16	E16	19	77	1	15,70
4325-E18	E18	20.3	77	1	15,70
4325-E20	E20	22.8	77	1	17,77
4325-E22	E22	25	77	1	20,65
4325-E24	E24	26.6	77	1	20,65

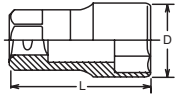

OTTAGONALE

 CHIAVI A BUSSOLA
A MANO BOCCA
OTTAGONALE

Koken articolo	mm	D mm	L mm		Euro
4300H-27-8P	27	34	57	1	31,38

per interruttori, Mercedes Benz e MAN

 SERIE 10 PZ. CHIAVI A BUSSOLA LUNGHE
MISURE: 10, 11, 12, 13, 14, 15, 17
19, 21, 22 MM

Koken articolo	mm	D mm	L mm		Euro
RS4300M/10				1	131,78
RS4305M/10				1	131,78
RS4310M/10				1	134,67

 SERIE 12 PZ. CHIAVI A BUSSOLA LUNGHE
MISURE: 10, 12, 13, 14, 15, 16, 17, 18
19, 20, 21, 22 MM

Koken articolo	mm	D mm	L mm		Euro
RS4300M/12				1	161,04

POLLICI

 SERIE 10 PZ. CHIAVI A BUSSOLA
LUNGHE MISURE: 3/8", 7/16", 1/2"
9/16", 5/8", 11/16", 3/4", 13/16", 7/8", 15/16"

Koken articolo	mm	D mm	L mm		Euro
RS4300A/10				1	144,73
RS4305A/10				1	148,56



SERIE 7 PZ. CHIAVI A BUSSOLA BOCCA TORX®

Koken articolo		D mm	L mm		Euro
RS4325/7	E10, E12, E14, E16, E18, E20, E24			1	112,50



ESAGONO

 CHIAVI A BUSSOLA
A MANO BOCCA
ESAGONALE
LUNGHE

Koken articolo	mm	D mm	L mm		€uro
4300M-L110-17	17	23	110	1	36,41
4300M-L110-19	19	25.8	110	1	36,41
4300M-L110-21	21	26.8	110	1	38,56



ESAGONO

 CHIAVI A BUSSOLA
A MANO BOCCA
ESAGONALE

Koken articolo	mm	D mm	L mm		€uro
4300M-L120-8	8	13.2	120	1	43,48
4300M-L120-10	10	15.3	120	1	43,48
4300M-L120-12	12	17.8	120	1	43,48
4300M-L120-14	14	20.3	120	1	43,48
4300M-L120-16	16	22.8	120	1	44,17

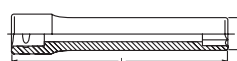

TORX®

 CHIAVI A BUSSOLA
A MANO BOCCA
TORX®

Koken articolo		D mm	L mm		€uro
4325-L140-E 8	E 8	10.7	140	1	57,31
4325-L140-E10	E10	13.2	140	1	55,77
4325-L140-E12	E12	14.6	140	1	55,77
4325-L140-E14	E14	16.5	140	1	55,77

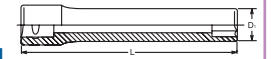

TORX BLOCCADADI

 CHIAVI A BUSSOLA
A MANO BOCCA
TORX® BLOCCADADI

Koken articolo		D mm	L mm		€uro
4325-L140-2B-E 8	E 8	10.7	140	1	63,53
4325-L140-2B-E10	E10	13.2	140	1	63,53
4325-L140-2B-E12	E12	14.6	140	1	63,53
4325-L140-2B-E14	E14	16.5	140	1	63,53

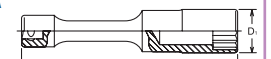

POLIGONALE

 CHIAVI A BUSSOLA
A MANO BOCCA
POLIGONALE
LUNGHE

Koken articolo	mm	D mm	L mm		€uro
4117M-125-13	13	18.7	125	1	28,55
4117M-125-14	14	20.2	125	1	28,55
4117M-125-17	17	24	125	1	28,55
4117M-125-19	19	26.9	125	1	31,38
4117M-125-21	21	28.5	125	1	32,97
4117M-125-22	22	30	125	1	32,97
4117M-125-24	24	32	125	1	34,51
4117M-125-27	27	36.5	125	1	37,59
4117M-125-30	30	40	125	1	41,03
4117M-125-32	32	42	125	1	44,30
4117M-250-13	13	18.7	250	1	32,23
4117M-250-14	14	20.2	250	1	32,23
4117M-250-17	17	24	250	1	32,23
4117M-250-19	19	26.9	250	1	35,26
4117M-250-21	21	28.5	250	1	37,81
4117M-250-22	22	30	250	1	37,81
4117M-250-24	24	32	250	1	39,63
4117M-250-27	27	36.5	250	1	42,87
4117M-250-30	30	40	250	1	46,59
4117M-250-32	32	42	250	1	48,70





ESAGONO

CHIAVI A BUSSOLA A MANO SNODATE BOCCA ESAGONALE

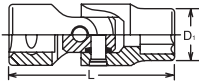

Koken articolo	mm	D ₁ mm	L mm		Euro
4440M-9	9	14	62.8	1	27,97
4440M-10	10	15.3	63.3	1	27,97
4440M-11	11	16.5	64.5	1	27,97
4440M-12	12	17.8	65	1	27,97
4440M-13	13	19	65.9	1	28,96
4440M-14	14	20.3	65.9	1	28,96
4440M-15	15	21.5	67.5	1	28,96
4440M-16	16	22.8	68	1	28,96
4440M-17	17	24	69	1	28,96
4440M-18	18	25.3	69	1	29,67
4440M-19	19	26.5	71	1	29,67
4440M-20	20	27.8	71	1	30,58
4440M-21	21	29	72	1	30,58
4440M-22	22	30.3	72	1	30,58

POLLICI



ESAGONO

CHIAVI A BUSSOLA A MANO SNODATE BOCCA ESAGONALE

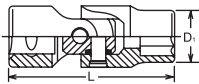

Koken articolo	pollici	D mm	L mm		Euro
4440A-3/8	3/8"	14.8	63.3	1	30,14
4440A-7/16	7/16"	16.5	64.5	1	30,14
4440A-1/2	1/2"	19	65.9	1	31,16
4440A-9/16	9/16"	20.3	65.9	1	31,16
4440A-5/8	5/8"	22.8	68	1	31,16
4440A-11/16	11/16"	24.6	69	1	31,96
4440A-3/4	3/4"	26.5	71	1	31,96
4440A-7/8	7/8"	30.3	72	1	32,92



TORX®

CHIAVI A BUSSOLA A MANO SNODATE BOCCA TORX

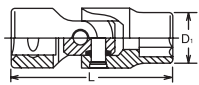

Koken articolo		D mm	L mm		Euro
4440T-E10	E10	13.2	62	1	31,05
4440T-E12	E12	15	63.3	1	31,05
4440T-E14	E14	16.3	64.5	1	31,05
4440T-E16	E16	18.8	65	1	31,05
4440T-E18	E18	20.4	66.5	1	31,05



PHILLIPS®

CHIAVI A BUSSOLA A CROCE PHILLIPS®

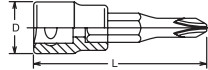

Koken articolo		D mm	L mm		Euro
4000-60 (PH)-2	PH2	22	60	1	10,67
4000-60 (PH)-3	PH3	22	60	1	10,67
4000-60 (PH)-4	PH4	22	60	1	10,67



POZIDRIV®

CHIAVI A BUSSOLA A CROCE POZIDRIV®

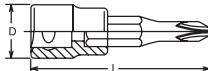

Koken articolo		D mm	L mm		Euro
4000-60-PZ2	PZ2	22	60	1	11,80
4000-60-PZ3	PZ3	22	60	1	11,80



TAGLIO

CHIAVI A BUSSOLA A TAGLIO

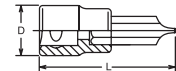

Koken articolo		D mm	L mm		Euro
4005-60-8	1.2x8	22	60	1	12,13
4005-60-10	1.6x10	22	60	1	12,84
4005-60-12	2.0x12	23	60	1	12,84
4005-60-14	2.5x14	23	60	1	13,75
4005-60-16	2.5x16	24	60	1	14,27



TAGLIO

CHIAVI A BUSSOLA A TAGLIO

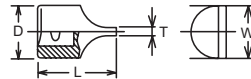

Koken articolo		T x W	D mm	L mm		Euro
4101-1		2.7x18.6	22	40	1	16,36
4101-2		3.7x24	24	40	1	16,67
4101-3		3.7x30	30	40	1	27,09



ESAGONO

CHIAVI A BUSSOLA MASCHIO ESAGONALE

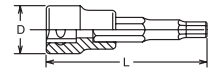

Koken articolo		D mm	L mm		Euro
4010M-50-4	4	22	50	1	8,83
4010M-50-5	5	22	50	1	8,83
4010M-50-6	6	22	50	1	8,83
4010M-50-7	7	22	50	1	9,35
4010M-50-8	8	22	50	1	9,35
4010M-50-9	9	22	50	1	9,35
4010M-50-10	10	22	50	1	9,35
4010M-50-12	12	23	50	1	10,01
4010M-50-13	13	24	50	1	10,81
4010M-50-14	14	24	50	1	10,81
4010M-50-16	16	25	50	1	12,18
4010M-50-17	17	25	50	1	12,18
4010M-50-18	18	27	50	1	13,75
4010M-50-19	19	27	50	1	13,75
4010M-75-4	4	22	75	1	9,30
4010M-75-5	5	22	75	1	9,30
4010M-75-6	6	22	75	1	9,30
4010M-75-7	7	22	75	1	9,68
4010M-75-8	8	22	75	1	9,68
4010M-75-9	9	22	75	1	9,68
4010M-75-10	10	22	75	1	9,68
4010M-75-11	11	23	75	1	10,67
4010M-75-12	12	23	75	1	10,40
4010M-75-13	13	24	75	1	11,25
4010M-75-14	14	24	75	1	11,25
4010M-75-16	16	25	75	1	12,24
4010M-75-17	17	25	75	1	12,24
4010M-75-18	18	27	75	1	14,11
4010M-75-19	19	27	75	1	14,11
4010M-100-4	4	22	100	1	9,98
4010M-100-5	5	22	100	1	9,98
4010M-100-6	6	22	100	1	9,98
4010M-100-7	7	22	100	1	10,15
4010M-100-8	8	22	100	1	10,15
4010M-100-9	9	22	100	1	10,67
4010M-100-10	10	22	100	1	10,67
4010M-100-12	12	23	100	1	11,25
4010M-100-13	13	24	100	1	12,43
4010M-100-14	14	24	100	1	12,43
4010M-100-16	16	25	100	1	14,00
4010M-100-17	17	25	100	1	14,00
4010M-100-18	18	27	100	1	15,37
4010M-100-19	19	27	100	1	15,37
4010M-160-4	4	22	160	1	11,77
4010M-160-5	5	22	160	1	11,77
4010M-160-6	6	22	160	1	11,77
4010M-160-7	7	22	160	1	12,13
4010M-160-8	8	22	160	1	12,13
4010M-160-10	10	22	160	1	13,01
4010M-160-12	12	23	160	1	13,89
4010M-160-14	14	24	160	1	15,21
4010M-160-17	17	25	160	1	17,19
4010M-160-19	19	27	160	1	19,03

KOKEN 1/2"

POLLICI

NEW



ESAGONO

CHIAVI A BUSSOLA
MASCHIO
ESAGONALE
IN POLLICI

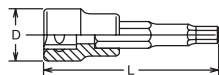

Koken articolo	pollici	D mm	L mm		Euro
4010A-60-5/32	5/32"	22	60	1	10,45
4010A-60-3/16	3/16"	22	60	1	10,45
4010A-60-7/32	7/32"	22	60	1	10,45
4010A-60-1/4	1/4"	22	60	1	10,45
4010A-60-9/32	9/32"	22	60	1	11,28
4010A-60-5/16	5/16"	22	60	1	11,28
4010A-60-11/32	11/32"	22	60	1	11,58
4010A-60-3/8	3/8"	22	60	1	11,58
4010A-60-7/16	7/16"	23	60	1	12,13
4010A-60-1/2	1/2"	24	60	1	13,50
4010A-60-9/16	9/16"	25	60	1	13,50
4010A-60-5/8	5/8"	25	60	1	13,78
4010A-60-3/4	3/4"	27	60	1	15,57



ESAGONO

SERIE 10 PZ. CHIAVI A BUSSOLA MASCHIO ESAGONALE

Koken articolo	mm	L mm		Euro
RS4010M/10-L50	4, 5, 6, 7, 8, 10, 12, 14, 17, 19	50	1	98,45
RS4010M/10-L75	4, 5, 6, 7, 8, 10, 12, 14, 17, 19	75	1	101,86
NEW RS4010A/10-L60	3/16", 7/32", 1/4", 5/16", 3/8", 7/16", 1/2", 9/16", 5/8", 3/4"	60	1	119,71

POLLICI



POLIGONALE

CHIAVI A BUSSOLA
MASCHIO
POLIGONALE
PER TOYOTA



Koken articolo	mm	D mm	L mm		Euro
4010M-100-8-12P	8	23	100	1	16,06
4010M-100-10-12P	10	23	100	1	16,89
4010M-120-8-12P	8	23	120	1	17,19
4010M-120-10-12P	10	23	120	1	17,24



ESAGONO

CHIAVI A BUSSOLA
MASCHIO ESAGONALE
INTEGRALI

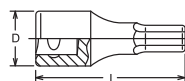

Koken articolo	mm	D mm	L mm		Euro
4012M-43-4	4	21.1	43	1	10,62
4012M-43-5	5	21.1	43	1	10,62
4012M-43-6	6	21.1	43	1	10,62
4012M-43-7	7	21.1	43	1	10,62
4012M-43-8	8	21.1	43	1	10,62
4012M-43-9	9	21.1	43	1	10,62
4012M-43-10	10	23	43	1	10,86
4012M-43-11	11	24	43	1	11,77
4012M-43-12	12	24	43	1	11,77
4012M-43-13	13	24	43	1	11,77
4012M-43-14	14	24	43	1	11,77
4012M-43-15	15	24	43	1	11,91
4012M-43-16	16	24	43	1	11,91
4012M-43-17	17	24	43	1	11,91
4012M-43-18	18	24	43	1	12,13
4012M-43-19	19	24	43	1	12,13
4012M-43-20	20	24	43	1	17,41
4012M-43-21	21	24	43	1	17,41
4012M-43-22	22	24	43	1	17,41
4012M-43-23	23	24	43	1	18,18
4012M-43-24	24	24	43	1	18,29
4012M-43-27	27	24	43	1	22,58
4012M-60-4	4	21.1	60	1	11,52
4012M-60-5	5	21.1	60	1	11,52
4012M-60-6	6	21.1	60	1	11,52
4012M-60-7	7	21.1	60	1	11,52
4012M-60-8	8	21.1	60	1	11,52
4012M-60-9	9	21.1	60	1	11,61
4012M-60-10	10	23	60	1	11,61
4012M-60-11	11	24	60	1	12,43
4012M-60-12	12	24	60	1	12,43
4012M-60-13	13	24	60	1	12,62
4012M-60-14	14	24	60	1	12,62
4012M-60-15	15	24	60	1	13,45
4012M-60-16	16	24	60	1	13,45
4012M-60-17	17	24	60	1	13,45
4012M-60-18	18	24	60	1	13,94
4012M-60-19	19	24	60	1	13,94
4012M-60-21	21	24	60	1	21,15
4012M-60-22	22	24	60	1	21,81
4012M-60-23	23	24	60	1	22,41
4012M-60-24	24	24	60	1	22,41



ESAGONO

CHIAVI A BUSSOLA
MASCHIO ESAGONALE
INTEGRALI

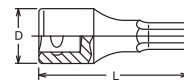

Koken articolo	mm	D mm	L mm		Euro
4012M-75-4	4	21.1	75	1	12,43
4012M-75-5	5	21.1	75	1	12,43
4012M-75-6	6	21.1	75	1	12,43
4012M-75-7	7	21.1	75	1	12,43
4012M-75-8	8	21.1	75	1	12,43
4012M-75-9	9	21.1	75	1	12,95
4012M-75-10	10	23	75	1	12,95
4012M-75-11	11	24	75	1	13,50
4012M-75-12	12	24	75	1	13,50
4012M-75-13	13	24	75	1	13,83
4012M-75-14	14	24	75	1	13,83
4012M-75-15	15	24	75	1	15,18
4012M-75-16	16	24	75	1	15,18
4012M-75-17	17	24	75	1	15,18
4012M-75-18	18	24	75	1	16,67
4012M-75-19	19	24	75	1	16,67
NEW 4012M-75-22	22	26	75	1	24,72
NEW 4012M-75-24	24	27.9	75	1	24,72
4012M-100-4	4	21.1	100	1	16,36
4012M-100-5	5	21.1	100	1	16,36
4012M-100-6	6	21.1	100	1	16,36
4012M-100-7	7	21.1	100	1	16,36
4012M-100-8	8	21.1	100	1	16,36
4012M-100-9	9	21.1	100	1	16,94
4012M-100-10	10	23	100	1	16,94
4012M-100-11	11	24	100	1	17,66
4012M-100-12	12	24	100	1	17,66
4012M-100-13	13	24	100	1	17,85
4012M-100-14	14	24	100	1	17,85
4012M-100-15	15	24	100	1	19,99
4012M-100-16	16	24	100	1	19,99
4012M-100-17	17	24	100	1	19,99
4012M-100-18	18	24	100	1	22,58
4012M-100-19	19	24	100	1	22,58



ESAGONO

SERIE 10 PZ. CHIAVI A BUSSOLA BOCCA ESAGONALE

Koken articolo	mm	L mm		Euro
RS4012M/10-L60	4, 5, 6, 7, 8, 10, 12, 14, 17, 19	60	1	118,36
POLLICI RS4012A/10-L60	3/16", 7/32", 1/4", 5/16", 3/8", 7/16", 1/2", 9/16", 5/8", 3/4"	60	1	125,37



POLLICI



ESAGONO

CHIAVI A BUSSOLA MASCHIO ESAGONALE INTEGRALI

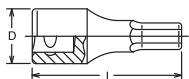

Koken articolo	pollici	D mm	L mm		Euro
4012A-43-5/32	5/32"	21.1	43	1	11,41
4012A-43-3/16	3/16"	21.1	43	1	11,41
4012A-43-7/32	7/32"	21.1	43	1	11,41
4012A-43-1/4	1/4"	21.1	43	1	11,41
4012A-43-9/32	9/32"	21.1	43	1	11,41
4012A-43-5/16	5/16"	21.1	43	1	11,41
4012A-43-11/32	11/32"	21.1	43	1	11,41
4012A-43-3/8	3/8"	23	43	1	11,69
4012A-43-7/16	7/16"	25	43	1	12,65
4012A-43-1/2	1/2"	25	43	1	12,65
4012A-43-9/16	9/16"	25	43	1	12,65
4012A-43-5/8	5/8"	26	43	1	12,82
4012A-43-3/4	3/4"	26	43	1	13,09
4012A-43-7/8	7/8"	26	43	1	18,76
4012A-60-5/32	5/32"	21.1	60	1	12,13
4012A-60-3/16	3/16"	21.1	60	1	12,13
4012A-60-7/32	7/32"	21.1	60	1	12,13
4012A-60-1/4	1/4"	21.1	60	1	12,13
4012A-60-9/32	9/32"	21.1	60	1	12,13
4012A-60-5/16	5/16"	21.1	60	1	12,13
4012A-60-11/32	11/32"	21.1	60	1	12,16
4012A-60-3/8	3/8"	21.5	60	1	12,16
4012A-60-7/16	7/16"	24	60	1	13,09
4012A-60-1/2	1/2"	24	60	1	13,23
4012A-60-9/16	9/16"	24	60	1	13,23
4012A-60-5/8	5/8"	24	60	1	14,16
4012A-60-3/4	3/4"	24	60	1	14,63
4012A-60-7/8	7/8"	26	60	1	22,94
4012A-75-5/32	5/32"	21.1	75	1	13,06
4012A-75-3/16	3/16"	21.1	75	1	13,06
4012A-75-7/32	7/32"	21.1	75	1	13,06
4012A-75-1/4	1/4"	21.1	75	1	13,06
4012A-75-9/32	9/32"	21.1	75	1	13,06
4012A-75-5/16	5/16"	21.1	75	1	13,06
4012A-75-11/32	11/32"	21.1	75	1	13,61
4012A-75-3/8	3/8"	21.5	75	1	13,61
4012A-75-7/16	7/16"	24	75	1	14,22
4012A-75-1/2	1/2"	24	75	1	14,49
4012A-75-9/16	9/16"	24	75	1	14,49
4012A-75-5/8	5/8"	24	75	1	15,92
4012A-75-3/4	3/4"	24	75	1	17,49
4012A-75-7/8	7/8"	26	75	1	25,96
4012A-100-5/32	5/32"	21.1	100	1	17,22
4012A-100-3/16	3/16"	21.1	100	1	17,22
4012A-100-7/32	7/32"	21.1	100	1	17,22
4012A-100-1/4	1/4"	21.1	100	1	17,22
4012A-100-9/32	9/32"	21.1	100	1	17,22
4012A-100-5/16	5/16"	21.1	100	1	17,22
4012A-100-11/32	11/32"	21.1	100	1	17,79
4012A-100-3/8	3/8"	21.5	100	1	17,79
4012A-100-7/16	7/16"	24	100	1	18,51
4012A-100-1/2	1/2"	24	100	1	18,78
4012A-100-9/16	9/16"	24	100	1	18,78
4012A-100-5/8	5/8"	24	100	1	20,96
4012A-100-3/4	3/4"	24	100	1	23,76

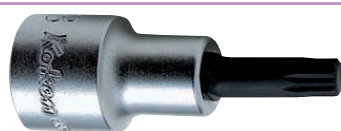

XZN

CHIAVI A BUSSOLA MASCHIO XZN

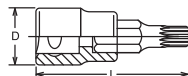

Koken articolo		D mm	L mm		Euro
4020-60-M 5	M 5	22	60	1	11,69
4020-60-M 6	M 6	22	60	1	11,69
4020-60-M 8	M 8	22	60	1	11,96
4020-60-M10	M10	23	60	1	12,13
4020-60-M12	M12	23	60	1	12,79
4020-60-M14	M14	23	60	1	13,31
4020-60-M16	M16	25	60	1	19,64
4020-60-M18	M18	27	60	1	19,64
4020-100-M 5	M 5	22	100	1	12,49
4020-100-M 6	M 6	22	100	1	12,49
4020-100-M 8	M 8	22	100	1	12,49
4020-100-M10	M10	23	100	1	13,59
4020-100-M12	M12	23	100	1	14,52
4020-100-M14	M14	23	100	1	15,51
4020-100-M16	M16	25	100	1	22,36
4020-100-M18	M18	27	100	1	38,56
4020-120-M 5	M 5	22	120	1	13,17
4020-120-M 6	M 6	22	120	1	13,17
4020-120-M 8	M 8	22	120	1	13,17
4020-120-M10	M10	23	120	1	14,16
4020-120-M12	M12	23	120	1	14,99
4020-120-M14	M14	23	120	1	17,82
4020-140-M 5	M 5	22	140	1	15,37
4020-140-M 6	M 6	22	140	1	15,37
4020-140-M 8	M 8	22	140	1	15,37
4020-140-M10	M10	23	140	1	15,51
4020-140-M12	M12	23	140	1	17,02
4020-140-M14	M14	23	140	1	18,56

XZN



SERIE 6 PZ. CHIAVI A BUSSOLA BOCCA XZN

Koken articolo		L mm		Euro
RS4020/6-L60	M5, M6, M8, M10, M12, M14	60	1	71,47
RS4020/6-L100	M5, M6, M8, M10, M12, M14	100	1	75,57

XZN



S mm	S mm
M 4	3,60
M 5	4,80
M 6	6,10
M 8	7,30
M 10	9,70
M12	11,50
M14	13,30
M16	15,70
M18	16,90



XZN CON FORO

CHIAVI A BUSSOLA MASCHIO XZN CON FORO

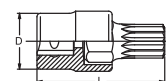

Koken articolo		D mm	L mm		Euro
4020-60-MH	MH16	25	60	1	32,42

Per tappo della scatola del cambio AUDI, VW, PORSCHE



TORX®

CHIAVI A BUSSOLA MASCHIO TORX®

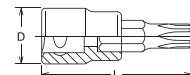

Koken articolo		D mm	L mm		Euro
4025-60-T15	TX 15	22	60	1	10,59
4025-60-T20	TX 20	22	60	1	10,59
4025-60-T25	TX 25	22	60	1	10,59
4025-60-T27	TX 27	22	60	1	10,59
4025-60-T30	TX 30	22	60	1	10,59
4025-60-T35	TX 35	22	60	1	14,36
4025-60-T40	TX 40	22	60	1	12,07
4025-60-T45	TX 45	22	60	1	12,07
4025-60-T50	TX 50	22	60	1	12,07
4025-60-T55	TX 55	23	60	1	13,75
4025-60-T60	TX 60	24	60	1	14,25
4025-60-T70	TX 70	24	60	1	26,10
4025-60-T80	TX 80	24	60	1	26,59
4025-100-T20	TX 20	22	100	1	14,30
4025-100-T25	TX 25	22	100	1	14,30
4025-100-T27	TX 27	22	100	1	14,30
4025-100-T30	TX 30	22	100	1	14,30
4025-100-T40	TX 40	22	100	1	14,91
4025-100-T45	TX 45	22	100	1	14,91
4025-100-T50	TX 50	22	100	1	14,91
4025-100-T55	TX 55	23	100	1	16,58
4025-100-T60	TX 60	24	100	1	16,86
4025-100-T70	TX 70	24	100	1	34,13
4025-140-T20	TX 20	22	140	1	16,58
4025-140-T25	TX 25	22	140	1	16,58
4025-140-T27	TX 27	22	140	1	16,58
4025-140-T30	TX 30	22	140	1	16,58
4025-140-T40	TX 40	22	140	1	17,30
4025-140-T45	TX 45	22	140	1	17,30
4025-140-T50	TX 50	22	140	1	17,30
4025-140-T55	TX 55	23	140	1	18,04
4025-140-T60	TX 60	24	140	1	18,37
4025-140-T70	TX 70	24	140	1	39,19
4025-140-T80	TX 80	24	140	1	42,13

KOKEN 1/2"

TORX®

SERIE 9 PZ. CHIAVI A BUSSOLA BOCCA TORX®

Koken articolo	L mm	Euro
TX 20, 25, 27, RS4025/9-L60	60	102,47

TORXplus®

CHIAVI A BUSSOLA MASCHIO TORX® PLUS

Koken articolo	D mm	L mm	Euro
4025-60-20IP	22	60	14,08
4025-60-25IP	22	60	14,08
4025-60-27IP	22	60	14,08
4025-60-30IP	22	60	14,08
4025-60-40IP	22	60	15,79
4025-60-45IP	22	60	15,79
4025-60-50IP	22	60	15,79
4025-60-55IP	23	60	17,77
4025-60-60IP	24	60	18,48
4025-60-70IP	25	60	33,77
4025-100-40IP	22	100	18,12
4025-100-45IP	22	100	18,12
4025-100-50IP	22	100	18,12
4025-100-55IP	23	100	20,24
4025-100-60IP	24	100	20,24
4025-100-70IP	25	100	40,81

TORXplus®

SERIE 9 PZ. CHIAVI A BUSSOLA BOCCA TORX® PLUS

Koken articolo	L mm	Euro
RS4025/9-IP	60	129,58

TORXplus®	S mm	S mm	
8 IP	2.30	30 IP	5.60
9 IP	2.50	40 IP	6.70
10 IP	2.70	45 IP	7.90
15 IP	3.30	50 IP	8.90
20 IP	3.90	55 IP	11.30
25 IP	4.50	60 IP	13.30
27 IP	5.00		

RIBE

CHIAVI A BUSSOLA MASCHIO RIBE

Koken articolo	D mm	L mm	Euro	
4027-60-M5	M 5	22	60	15,76
4027-60-M6	M 6	22	60	15,76
4027-60-M7	M 7	22	60	16,47
4027-60-M8	M 8	22	60	16,47
4027-60-M9	M 9	22	60	17,90
4027-60-M10	M10	22	60	17,90
4027-60-M12	M12	23	60	19,91
4027-60-M13	M13	24	60	22,33
4027-60-M14	M14	24	60	22,33
4027-60-M16	M16	24	60	24,67
4027-100-M5	M 5	22	100	16,06
4027-100-M6	M 6	22	100	16,28
4027-100-M7	M 7	22	100	17,19
4027-100-M8	M 8	22	100	17,19
4027-100-M9	M 9	22	100	19,91
4027-100-M10	M10	22	100	20,49
4027-100-M12	M12	23	100	22,39
4027-100-M13	M13	24	100	24,39
4027-100-M14	M14	24	100	24,39
4027-100-M16	M16	24	100	26,43
4027-140-M8	M8	22	140	18,87
4027-140-M10	M10	22	140	21,12
4027-140-M12	M12	23	140	24,78
4027-140-M14	M14	24	140	25,77
4027-140-M16	M16	24	140	27,50

RIBE

SERIE 7 PZ. CHIAVI A BUSSOLA BOCCA RIBE

Koken articolo	L mm	Euro
RS4027/7-L60	60	125,90

RIBE

CHIAVI A BUSSOLA MASCHIO RIBE PER VW E AUDI

Koken articolo	D mm	L mm	Euro
ST4027-140	23	140	19,86

RIBE	S mm	W mm
M 5	5.00	1.20
M 6	6.00	1.30
M 7	7.00	1.40
M 8	8.00	1.80
M 9	9.00	2.00
M 10	10.00	2.30
M 12	12.00	2.60
M 13	13.00	3.10
M 14	14.00	3.20
M 16	16.00	3.60

MECCANISMO 24 DENTI

CRICCHETTO PORTABUSSOLA REVERSIBILE

Koken articolo	D mm	T mm	L mm	Euro
3749S-1/2	34	29	110	48,90

MECCANISMO 24 DENTI

CRICCHETTO PORTABUSSOLA REVERSIBILE CON PULSANTE DI SBLOCCAGGIO RAPIDO

Koken articolo	D mm	T mm	L mm	Euro
3749SB-1/2	34	29	110	60,17

MECCANISMO 30 DENTI

CRICCHETTO PORTABUSSOLA REVERSIBILE

Koken articolo	D mm	T mm	L mm	Euro
4750J	38	35,9	250	70,32

MECCANISMO 30 DENTI

CRICCHETTO PORTABUSSOLA REVERSIBILE CON PULSANTE DI SBLOCCAGGIO RAPIDO

Koken articolo	D mm	T mm	L mm	Euro
4750JB	38	35,9	250	86,21



MECCANISMO 30 DENTI

CRICCHETTO PORTABUSSOLA REVERSIBILE CON PULSANTE DI SBLOCCAGGIO RAPIDO

Koken	D mm	T mm	L mm		Euro
articolo	38	35,9	250	1	85,03

MECCANISMO 24 DENTI

CRICCHETTO PORTABUSSOLA REVERSIBILE CON PULSANTE DI SBLOCCAGGIO RAPIDO

Koken	D mm	T mm	L mm		Euro
articolo	38	36,2	250	1	71,28

MECCANISMO 24 DENTI

CRICCHETTO PORTABUSSOLA REVERSIBILE SNODATO - TIPO LUNGO

Koken	D mm	T mm	L mm		Euro
articolo	38	36,2	330	1	86,43
4774P-450	38	36,2	450	1	109,78

MECCANISMO 45 DENTI

CRICCHETTO PORTABUSSOLA REVERSIBILE

Koken	D mm	T mm	L mm		Euro
articolo	35	38,8	250	1	83,96

MECCANISMO 24 DENTI

CRICCHETTO PORTABUSSOLA REVERSIBILE TIPO LUNGO

Koken	D mm	T mm	L mm		Euro
articolo	44,6	33	380	1	83,33

MECCANISMO 24 DENTI

CRICCHETTO PORTABUSSOLA REVERSIBILE SNODATO CON PULSANTE DI SBLOCCAGGIO RAPIDO - TIPO LUNGO

Koken	D mm	T mm	L mm		Euro
articolo	38	36,2	330	1	94,52

MECCANISMO 24 DENTI

CRICCHETTO PORTABUSSOLA REVERSIBILE

Koken	D mm	T mm	L mm		Euro
articolo	38	36,2	250	1	61,82

MECCANISMO 24 DENTI

CRICCHETTO PORTABUSSOLA REVERSIBILE TIPO EXTRA LUNGO

Koken	D mm	T mm	L mm		Euro
articolo	38	36,2	410	1	104,45

MECCANISMO 45 DENTI

ADATTATORE A CRICCHETTO

Koken	D mm	L mm		Euro
articolo	33,5	65	1	60,91

MECCANISMO 24 DENTI

CRICCHETTO PORTABUSSOLA REVERSIBILE

Koken	D mm	T mm	L mm		Euro
articolo	38	36,2	250	1	60,03

MECCANISMO 24 DENTI

CRICCHETTO PORTABUSSOLA REVERSIBILE SNODATO - TIPO LUNGO

Koken	D mm	T mm	L mm		Euro
articolo	38	36,2	330	1	89,82

ADATTATORE A MANOPOLA PORTABUSSOLA

Koken	D mm	L mm		Euro
articolo	38	34,6	1	24,78

MECCANISMO 24 DENTI

CRICCHETTO PORTABUSSOLA REVERSIBILE CON PULSANTE DI SBLOCCAGGIO RAPIDO

Koken	D mm	T mm	L mm		Euro
articolo	38	36,2	250	1	75,74

MECCANISMO 24 DENTI

CRICCHETTO PORTABUSSOLA REVERSIBILE SNODATO CON PULSANTE DI SBLOCCAGGIO RAPIDO - TIPO LUNGO

Koken	D mm	T mm	L mm		Euro
articolo	38	36,2	330	1	99,03

QUADRO MASCHIO SNODATO CON IMPUGNATURA

Koken	D mm	L mm		Euro
articolo	28	380	1	50,08
4768J-450	28	450	1	53,60

KOKEN 1/2"

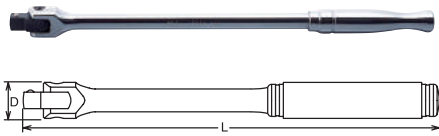

QUADRO MASCHIO SNODATO CON IMPUGNATURA

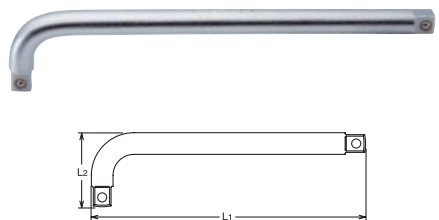
Koken articolo	D mm	L mm		Euro
4768P-380	28	380	1	48,70
4768P-450	28	450	1	53,90

DOPPIO QUADRO MASCHIO AD ANGOLO

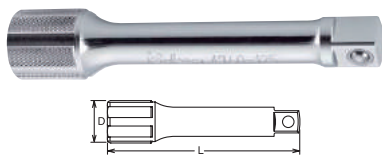
Koken articolo	L1 mm	L2 mm		Euro
4747	260	50	1	22,17

PROLUNGA CON ATTACCO QUADRO

Koken articolo	D mm	L mm		Euro
4760-50	24	50	1	12,07
4760-75	24	75	1	12,07
4760-100	24	100	1	13,89
4760-125	24	125	1	13,89
4760-150	24	150	1	16,61
4760-200	24	200	1	18,07
4760-250	24	250	1	18,07
4760-300	24	300	1	25,60
4760-400	24	400	1	34,27
4760-500	24	500	1	44,11
4760-600	24	600	1	43,48
4760-900	24	900	1	102,00
4760-1000	24	1000	1	102,00

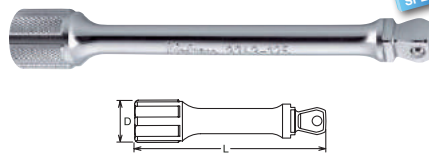

Koken articolo	DESCRIZIONE	Euro
PK4760/5	Set 5 prolunghe con attacco quadro	84,92
CARATTERISTICHE		
4760	50, 75, 125, 150, 250 mm	

PROLUNGA CON TESTA SFERICA

SISTEMA WOBBLE-FIX CON DUE MODALITÀ DI UTILIZZO:

- PROLUNGA TESTA SFERICA ANGOLO 15°
- PROLUNGA TRADIZIONALE

Koken articolo	D mm	L mm		Euro
4763-50	24	50	1	13,09
4763-75	24	75	1	15,81
4763-125	24	125	1	18,10
4763-150	24	150	1	24,15
4763-250	24	250	1	25,30
4763-400	24	400	1	55,39



SISTEMA WOBBLE-FIX CON DUE MODALITÀ DI UTILIZZO:

- PROLUNGA TESTA SFERICA ANGOLO 15°
- PROLUNGA TRADIZIONALE

Koken articolo	DESCRIZIONE	Euro
PK4763/5	Set 5 prolunghe con attacco quadro	108,90
CARATTERISTICHE		
4763	50, 75, 125, 150, 250 mm	

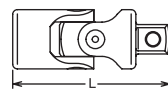

SNODO

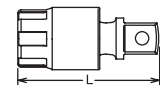
Koken articolo	L mm		Euro
4770	62,4	1	24,09

SNODO

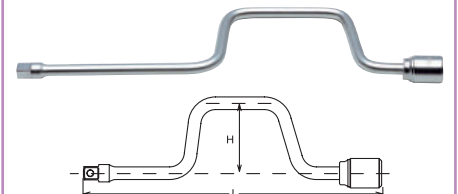
Koken articolo	L mm		Euro
4771	58,5	1	30,66

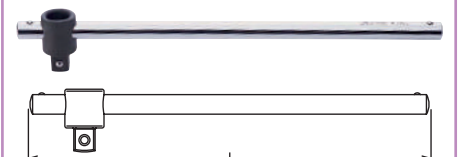

QUADRO MASCHIO CON MANOVELLA

Koken articolo	H mm	L mm		Euro
4780-400	100	400	1	30,53



L'innovativa barra a forma ovale offre una maggiore durata e impedisce al quadro scorrevole di ruotare attorno all'asta.

QUADRO MASCHIO CON ASTA SCORREVOLE OVALE

Koken articolo	L mm		Euro
4785K	300	1	20,54

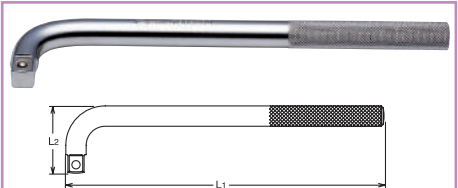

QUADRO MASCHIO AD ANGOLO

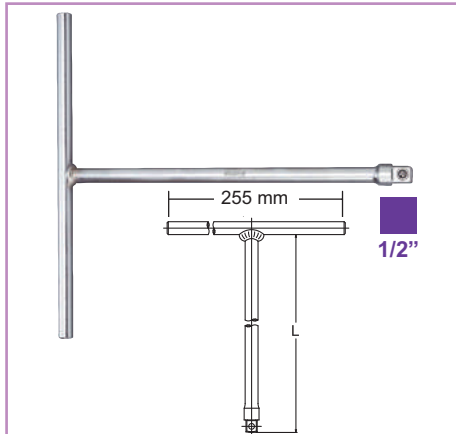
Koken articolo	L1 mm	L2 mm		Euro
4788-250K	250	53	1	21,89
4788-300K	300	53	1	23,32
4788-450K	450	53	1	31,16

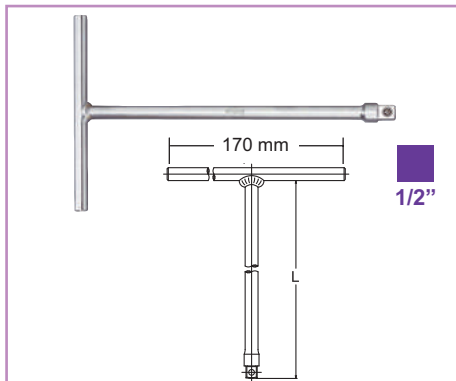

CHIAVI A "T" MASCHIO QUADRO 1/2"
LARGHEZZA IMPUGNATURA 255 MM

Koken articolo	pollici	L mm		Euro
4715-1/2	1/2"	255	1	22,47



CHIAVI A "T" MASCHIO QUADRO 1/2"
LARGHEZZA IMPUGNATURA 170 MM

Koken articolo	pollici	L mm		Euro
4715S-1/2	1/2"	170	1	22,47

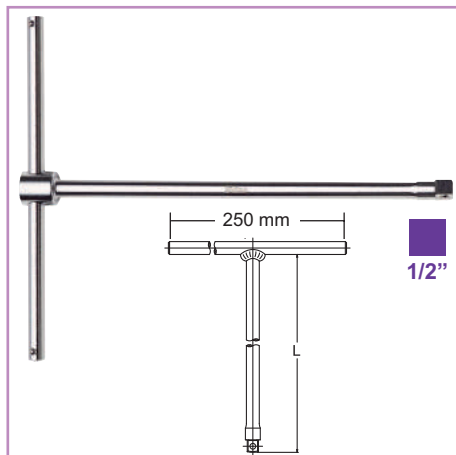

CHIAVI A "T" MASCHIO QUADRO 1/2" CON
ASTA SCORREVOLE LARGHEZZA 250 MM

Koken articolo	pollici	L mm		Euro
4715SL-1/2	1/2"	250	1	31,76

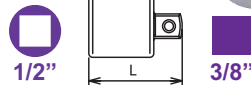

RACCORDO DI RIDUZIONE
QUADRO MASCHIO 3/8" E FEMMINA 1/2"

Koken articolo	L mm		Euro
4433A-35	35	1	11,25
4433A-75	75	1	13,64
4433A-125	125	1	13,64
4433A-250	250	1	18,56
4433A-600	600	1	38,72



RACCORDO DI RIDUZIONE
QUADRO MASCHIO 3/4" E FEMMINA 1/2"

Koken articolo	L mm		Euro
4466A	42	1	14,69



SERIE 22 PZ. CHIAVI A BUSSOLA
BOCCA ESAGONALE / POLIGONALE

Koken articolo	DESCRIZIONE		Euro
4251M-01	10, 11, 12, 13, 14, 15, 16, 17, 18, 19, 20, 21, 22, 23, 24, 25, 26, 27, 28, 29, 30, 32 MM	1	186,67
4251M-06	10, 11, 12, 13, 14, 15, 16, 17, 18, 19, 20, 21, 22, 23, 24, 25, 26, 27, 28, 29, 30, 32 MM	1	186,67



SERIE 13 PZ. CHIAVI A BUSSOLA
BOCCA ESAGONALE / POLIGONALE
CASSETTA METALLICA 168 X 60 X H 42 MM

Koken articolo	DESCRIZIONE		Euro
4252M-01	10, 11, 12, 13, 14, 15, 16, 17, 18, 19, 20, 21, 22 MM	1	94,99
4252M-06	10, 11, 12, 13, 14, 15, 16, 17, 18, 19, 20, 21, 22 MM	1	94,99



Koken articolo	DESCRIZIONE	Euro
P4241M-01	Cassetta metallica 28 Pz. 425 x 332 x h 65 mm	372,16







RICAMBI

BUSSOLE	DESCRIZIONE	Euro
4401M	10, 11, 12, 13, 14, 15, 16, 17, 18, 19, 20, 21, 22, 23, 24, 25, 26, 27, 28, 29, 30, 32	
4753J		
4760-125		
4760-250		
4768J-380		
4770		
4785		





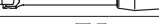





Koken articolo	DESCRIZIONE	Euro
P4241M-06	Cassetta metallica 28 Pz. 425 x 332 x h 65 mm	372,16

RICAMBI		
BUSSOLE  POLIGONALE	4405M	10, 11, 12, 13, 14, 15, 16, 17, 18, 19, 20, 21, 22, 23, 24, 25, 26, 27, 28, 29, 30, 32
	4753J	
ACCESSORI	4760-125	
	4760-250	
	4768J-380	
	4770	
	4785	









Koken articolo	DESCRIZIONE	Euro
4249M-01	Cassetta metallica 20 Pz. 445 x 190 x h 50 mm	256,55

RICAMBI		
BUSSOLE  ESAGONO	4401M	10, 11, 12, 13, 14, 15, 16, 17, 18, 19, 21, 22, 24, 27, 30
	4753J	
ACCESSORI	4760-125	
	4760-250	
	4768J-380	
	4770	
	4785	



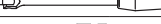





Koken articolo	DESCRIZIONE	Euro
4249M-06	Cassetta metallica 20 Pz. 445 x 190 x h 50 mm	256,55

RICAMBI		
BUSSOLE  POLIGONALE	4406M	10, 11, 12, 13, 14, 15, 16, 17, 18, 19, 21, 22, 24, 27, 30
	4753J	
ACCESSORI	4760-125	
	4760-250	
	4768J-380	
	4770	
	4785	



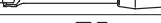





Koken articolo	DESCRIZIONE	Euro
4241M-01	Cassetta metallica 28 Pz. 446 x 266 x h 50 mm	396,85

RICAMBI		
BUSSOLE  ESAGONO	4401M	10, 11, 12, 13, 14, 15, 16, 17, 18, 19, 20, 21, 22, 23, 24, 25, 26, 27, 28, 29, 30, 32
	4753J	
ACCESSORI	4760-125	
	4760-250	
	4768J-380	
	4770	
	4785	



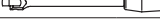



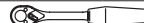

Koken articolo	DESCRIZIONE	Euro
4241M-06	Cassetta metallica 28 Pz. 446 x 266 x h 50 mm	396,85

RICAMBI		
BUSSOLE  POLIGONALE	4406M	10, 11, 12, 13, 14, 15, 16, 17, 18, 19, 20, 21, 22, 23, 24, 25, 26, 27, 28, 29, 30, 32
	4753J	
ACCESSORI	4760-125	
	4760-250	
	4768J-380	
	4770	
	4785	



Koken articolo	DESCRIZIONE	Euro
4241M-10	Cassetta metallica 28 Pz. 446 x 266 x h 50 mm	405,30

RICAMBI		
BUSSOLE  SURFACE DRIVE	4410M	10, 11, 12, 13, 14, 15, 16, 17, 18, 19, 20, 21, 22, 23, 24, 25, 26, 27, 28, 29, 30, 32
	4753J	
ACCESSORI	4760-125	
	4760-250	
	4768J-380	
	4770	
	4785	



POLLICI



Koken articolo	DESCRIZIONE	Euro
4241A-00	Cassetta metallica 19 Pz. 445 x 190 x h 50 mm	302,91
RICAMBI		
BUSSOLE ESAGONO	4400A	3/8", 7/16", 1/2", 9/16", 5/8", 11/16", 3/4", 13/16", 7/8", 15/16", 1-1/16", 1-1/8", 1-1/4"
	4753J	
ACCESSORI	4760-125	
	4760-250	
	4768J-380	
	4770	
	4785	

POLLICI



Koken articolo	DESCRIZIONE	Euro
4241A-05	Cassetta metallica 19 Pz. 445 x 190 x h 50 mm	302,91
RICAMBI		
BUSSOLE POLIGONALE	4405A	3/8", 7/16", 1/2", 9/16", 5/8", 11/16", 3/4", 13/16", 7/8", 15/16", 1-1/16", 1-1/8", 1-1/4"
	4753J	
ACCESSORI	4760-125	
	4760-250	
	4768J-380	
	4770	
	4785	



Koken articolo	DESCRIZIONE	Euro
4250M-01	Cassetta metallica 18 Pz. 445 x 190 x h 50 mm	249,45
RICAMBI		
BUSSOLE ESAGONO	4401M	10, 11, 12, 13, 14, 15, 17, 19, 22, 24, 27, 30, 32
	4753J	
ACCESSORI	4760-125	
	4760-250	
	4770	
	4785	



Koken articolo	DESCRIZIONE	Euro
4250M-06	Cassetta metallica 18 Pz. 445 x 190 x h 50 mm	249,45
RICAMBI		
BUSSOLE POLIGONALE	4406M	10, 11, 12, 13, 14, 15, 17, 19, 22, 24, 27, 30, 32
	4753J	
ACCESSORI	4760-125	
	4760-250	
	4770	
	4785	

MILLIMETRI
E POLLICI



Koken articolo	DESCRIZIONE	Euro
4272AM-01	Cassetta metallica 29 Pz. 445 x 190 x h 50 mm	318,59
RICAMBI		
BUSSOLE ESAGONO	4401M	10, 11, 12, 13, 14, 15, 16, 17, 18, 19, 21, 22, 24 mm
	4401A	3/8", 7/16", 1/2", 9/16", 5/8", 11/16", 3/4", 13/16", 7/8", 15/16", 1"
ACCESSORI	4753J	
	4760-125	
	4760-250	
	4768J-380	
	4770	
4785		

MILLIMETRI
E POLLICI



Koken articolo	DESCRIZIONE	Euro
4272AM-06	Cassetta metallica 29 Pz. 445 x 190 x h 50 mm	318,59
RICAMBI		
BUSSOLE POLIGONALE	4406M	10, 11, 12, 13, 14, 15, 16, 17, 18, 19, 21, 22, 24 mm
	4405A	3/8", 7/16", 1/2", 9/16", 5/8", 11/16", 3/4", 13/16", 7/8", 15/16", 1"
ACCESSORI	4753J	
	4760-125	
	4760-250	
	4768J-380	
	4770	
4785		



KOKEN 1/2"

PROMO



ALTA QUALITÀ MADE IN JAPAN

ESPOSITORE METALLICO 117 PEZZI CHIAVI A BUSSOLA

Koken articolo	DESCRIZIONE	TIPO BUSSOLE	NUMERO BUSSOLE	ATTACCO	Euro
S 4240M-01	CHIAVI A BUSSOLA ESAGONALI		117 PEZZI	 1/2"	790,16
S 4240M-06	CHIAVI A BUSSOLA POLIGONALI		117 PEZZI	 1/2"	790,16

CARATTERISTICHE

- espositore metallico: lunghezza 510 mm x larghezza 230 mm x altezza 150 mm
- bussole con attacco quadro femmina 1/2"
- con 117 bussole esagonali così assortite:

- 9 pezzi, bussole 10 mm
- 9 pezzi, bussole 11 mm
- 9 pezzi, bussole 12 mm
- 9 pezzi, bussole 13 mm
- 9 pezzi, bussole 14 mm
- 9 pezzi, bussole 15 mm
- 9 pezzi, bussole 16 mm
- 8 pezzi, bussole 17 mm
- 7 pezzi, bussole 19 mm
- 7 pezzi, bussole 21 mm
- 6 pezzi, bussole 22 mm
- 6 pezzi, bussole 23 mm
- 6 pezzi, bussole 24 mm
- 5 pezzi, bussole 27 mm
- 5 pezzi, bussole 30 mm
- 4 pezzi, bussole 32 mm



BUSSOLE CHROM-VANADIUM - SATINATE

Attacco: 1/2"
impronta: ESAGONO

BGS articolo	mm	L mm		Euro
BGS 2908	8	40	1	3,31
BGS 2909	9	40	1	3,31
BGS 2910	10	40	1	3,31
BGS 2911	11	40	1	3,31
BGS 2912	12	40	1	3,31
BGS 2913	13	40	1	3,31
BGS 2914	14	40	1	3,31
BGS 2915	15	40	1	3,31
BGS 2916	16	40	1	3,53
BGS 2917	17	40	1	3,80
BGS 2918	18	40	1	4,14
BGS 2919	19	40	1	4,14
BGS 2920	20	40	1	4,40
BGS 2921	21	40	1	4,59
BGS 2922	22	40	1	5,12
4615-0230	23	40	1	5,29
BGS 2924	24	40	1	5,29
4615-0250	25	40	1	7,32
BGS 2926	26	45	1	7,93
BGS 2927	27	45	1	8,27
4615-0280	28	45	1	8,27
4615-0290	29	45	1	8,38
BGS 2930	30	45	1	8,73
BGS 2932	32	45	1	9,52
BGS 2934	34	45	1	9,98
BGS 2935 NEW	35	45	1	13,52
BGS 2936	36	45	1	17,33
BGS 9845 NEW	38	45	1	17,33

POLLICI



BUSSOLE CHROM-VANADIUM - SATINATE IN POLLICI

Attacco: 1/2"
impronta: ESAGONO

BGS articolo	pollici	L mm		Euro
BGS 2770	3/8"	40	1	3,50
BGS 2771	7/16"	40	1	3,50
BGS 2772	1/2"	40	1	3,50
BGS 2773	9/16"	40	1	3,50
BGS 2774	5/8"	40	1	3,50
BGS 2775	11/16"	40	1	3,50
BGS 2776	3/4"	40	1	3,50
BGS 2777	13/16"	40	1	3,90
BGS 2778	7/8"	40	1	3,90
BGS 2779	15/16"	40	1	3,90
BGS 2787 NEW	1"	40	1	4,59
BGS 2784 NEW	1 1/16"	40	1	5,10
BGS 2788 NEW	1 1/8"	40	1	5,61
BGS 2786 NEW	1 1/4"	40	1	6,12



BUSSOLE CHROM-VANADIUM POLIGONALI - SATINATE

Attacco: 1/2"
impronta: POLIGONALI

BGS articolo	mm	L mm		Euro
BGS 10628	8	40	1	2,81
BGS 10629	9	40	1	2,81
BGS 10630	10	40	1	2,81
BGS 10631	11	40	1	2,81
BGS 10632	12	40	1	2,81
BGS 10633	13	40	1	3,06
BGS 10634	14	40	1	3,06
BGS 10635	15	40	1	3,06
BGS 10636	16	40	1	3,06
BGS 10637	17	40	1	2,81
BGS 10638	18	40	1	3,06
BGS 10639	19	40	1	3,06
BGS 10640	20	40	1	3,70
BGS 10641	21	40	1	3,70
BGS 10642	22	40	1	4,08
BGS 10644	24	40	1	4,34
BGS 10626 NEW	26	40	1	4,85
BGS 10645	27	40	1	5,61
BGS 10625 NEW	28	77	1	6,12
BGS 10646	30	40	1	6,63
BGS 10647	32	40	1	7,65
BGS 10648	34	40	1	11,99
BGS 10649	36	40	1	14,28



DESCRIZIONE
SET 6 PEZZI, INSERTI ANTI-GRAFFIO PER CHIAVI A BUSSOLA ESAGONALI
Euro 8,00

CARATTERISTICHE

- inserti speciali che, utilizzati all'interno delle bussole esagonali tradizionali, consentono di prevenire danni a parti cromate o verniciate o, più in generale, con trattamenti superficiali
- comprende:
 - inserto 8 mm, per bussola 12 mm, coppia 9 Nm
 - inserto 10 mm, per bussola 14 mm, coppia 17 Nm
 - inserto 12 mm, per bussola 16 mm, coppia 27 Nm
 - inserto 13 mm, per bussola 17 mm, coppia 45 Nm
 - inserto 15 mm, per bussola 19 mm, coppia 50 Nm
 - inserto 17 mm, per bussola 22 mm, coppia 79 Nm
- per uso con bussole esagonali metriche

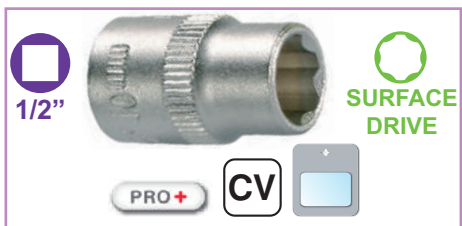

BUSSOLE CHROM-VANADIUM - SATINATE SURFACE DRIVE



Attacco: 1/2"
impronta: SURFACE-DRIVE

BGS articolo	mm	L mm		Euro
BGS 2408	8	40	1	2,42
BGS 2409	9	40	1	2,42
BGS 2410	10	40	1	2,42
BGS 2411	11	40	1	2,42
BGS 2412	12	40	1	2,55
BGS 2413	13	40	1	2,55
BGS 2414	14	40	1	2,55
BGS 2415	15	40	1	2,55
BGS 2416	16	40	1	2,55
BGS 2417	17	40	1	2,81
BGS 2418	18	40	1	2,81
BGS 2419	19	40	1	3,06
BGS 2420	20	40	1	3,32
BGS 2421	21	40	1	3,44
BGS 2422	22	40	1	3,83
BGS 2424	24	40	1	4,08
BGS 2427	27	45	1	5,23
BGS 2428 NEW	28	45	1	5,61
BGS 2430	30	45	1	6,38
BGS 2432	32	45	1	6,89



TORX® SATINATE

Attacco: 1/2"
impronta: TORX®

BGS articolo		L mm		Euro
BGS 6460	E 10	40	1	4,32
BGS 6461	E 11	40	1	4,32
BGS 6462	E 12	40	1	4,32
BGS 6464	E 14	40	1	4,32
BGS 6466	E 16	40	1	4,32
BGS 6418	E 18	40	1	4,70
BGS 6420	E 20	40	1	5,08
BGS 6422	E 22	40	1	5,08
BGS 6424	E 24	40	1	5,46

TORX®	S mm	S mm	
E 4	3.70	E 16	14.60
E 5	4.60	E 18	16.50
E 6	5.60	E 20	18.30
E 7	6.10	E 22	20.10
E 8	7.40	E 24	22.00
E 10	9.30	E 26	23.70
E 11	9.90	E 28	25.50
E 12	11.00	E 30	27.30
E 14	12.80	E 32	29.00

1/2"

BUSSOLE MULTIMPRONTA SPLINE DRIVE

MULTIMPRONTA SPLINE DRIVE

1/2"

mm Pollici Torx® XZN®

BUSSOLE CHROM-VANADIUM MULTIMPRONTA SPLINE-DRIVE

Attacco: 1/2"
impronta: SPLINE DRIVE

BGS articolo	mm	L mm		Euro
BGS 10208	8	40	1	3,44
BGS 10209	9	40	1	3,44
BGS 10210	10	40	1	3,57
BGS 10211	11	40	1	3,57
BGS 10212	12	40	1	3,57
BGS 10213	13	40	1	3,57
BGS 10214	14	40	1	3,57
BGS 10215	15	40	1	3,57
BGS 10216	16	40	1	3,70
BGS 10217	17	40	1	3,95
BGS 10218	18	40	1	4,08
BGS 10219	19	40	1	4,34
BGS 10220	20	40	1	4,85
BGS 10221	21	40	1	4,85
BGS 10222	22	40	1	5,23
BGS 10224	24	40	1	5,48
BGS 10227	27	40	1	6,76
BGS 10230	30	45	1	6,89
BGS 10232	32	45	1	7,65

NEW

1/2" PRO+ CV ESAGONO

BGS articolo DESCRIZIONE Euro

BGS 9108 SET 7 PEZZI, BUSSOLE ESAGONALI 20-32 MM, ATT. 1/2" 29,33

CARATTERISTICHE

- misure: 20 - 21 - 22 - 24 - 27 - 30 - 32 mm
- finitura cromata satinata
- zigrinate
- su guida metallica

NEW

1/2" PRO+ CV POLIGONALE

BGS articolo DESCRIZIONE Euro

BGS 9109 SET 7 PEZZI, BUSSOLE POLIGONALI 20-32 MM, ATT. 1/2" 29,58

CARATTERISTICHE

- misure: 20 - 21 - 22 - 24 - 27 - 30 - 32 mm
- finitura cromata satinata, zigrinate
- su guida metallica

POLLICI NEW

1/2" PRO+ CV ESAGONO

BGS articolo DESCRIZIONE Euro

BGS 9113 SET 10 PEZZI, BUSSOLE ESAGONALI IN POLLICI 3/8" - 15/16", ATT. 1/2" 24,99

CARATTERISTICHE

- misure: 3/8" - 7/16" - 1/2" - 9/16" - 5/8" - 11/16" - 3/4" - 13/16" - 7/8" - 15/16"
- finitura cromata satinata, zigrinate
- su guida metallica

POLLICI NEW

1/2" PRO+ CV POLIGONALE

BGS articolo DESCRIZIONE Euro

BGS 9114 SET 10 PEZZI, BUSSOLE POLIGONALI IN POLLICI 3/8" - 15/16", ATT. 1/2" 24,99

CARATTERISTICHE

- misure: 3/8" - 7/16" - 1/2" - 9/16" - 5/8" - 11/16" - 3/4" - 13/16" - 7/8" - 15/16"
- finitura cromata satinata, zigrinate
- su guida metallica

NEW

1/2" PRO+ CV ESAGONO

BGS articolo DESCRIZIONE Euro

BGS 9106 SET 11 PEZZI, BUSSOLE ESAGONALI 10-21 MM, ATT. 1/2" 22,70

CARATTERISTICHE

- misure: 10 - 11 - 12 - 13 - 14 - 15 - 16 - 17 - 18 - 19 - 21 mm
- finitura cromata satinata
- zigrinate
- su guida metallica

NEW

1/2" PRO+ CV POLIGONALE

BGS articolo DESCRIZIONE Euro

BGS 9107 SET 11 PEZZI, BUSSOLE POLIGONALI 10-21 MM, ATT. 1/2" 23,72

CARATTERISTICHE

- misure: 10 - 11 - 12 - 13 - 14 - 15 - 16 - 17 - 18 - 19 - 21 mm
- finitura cromata satinata
- zigrinate
- su guida metallica

1/2" TORXplus

PRO+ CV

BGS articolo DESCRIZIONE Euro

BGS 8806 SET 8 PEZZI, BUSSOLE TORX PLUS 18-32 EP, ATT. 1/2" 82,88

CARATTERISTICHE



- nuova impronta Torx Plus
- angolo d'applicazione è di 0 gradi, rispetto i 15 gradi dell'impronta Torx tradizionale
- misure: 18EP - 20EP - 22EP - 24EP - 26EP - 28EP - 30EP - 32EP
- finitura cromata lucida
- su guida metallica
- utilizzo settore automotive e veicoli industriali



 **TRIANGOLO**



BUSSOLE TRIANGOLARI

BGS articolo		L mm		Euro
BGS 7460	8	40	1	7,65
BGS 7461	10	40	1	7,65
BGS 7462	12	40	1	7,91
BGS 7463	15	40	1	8,54
BGS 7464	16,5	40	1	8,54

CARATTERISTICHE

- finitura cromata satinata
- zigrinate
- attacco quadro da 1/2"
- idonee per adattatore pompa iniettore VAG TDI, Iniettori Bosch, quadri di comando e barriere



BGS articolo	DESCRIZIONE	Euro
BGS 8608	SET 5 PZ, BUSSOLE TRIANGOLARI, M5 - M12 (8 - 16,5 MM)	34,43

CARATTERISTICHE

- Set bussole a triangolari: M5 - M6 - M8 - M10 - M12
- finitura cromata satinata
- zigrinate
- attacco quadro da 1/2"
- idonee per adattatore pompa iniettore VAG TDI, Iniettori Bosch, quadri di comando e barriere

POLLICI **NEW**



BGS articolo	DESCRIZIONE	Euro
BGS 2246	SET 23 PEZZI, BUSSOLE ESAGONALI IN POLLICI	62,48

CARATTERISTICHE

- bussole esagonali attacco 1/4": 5/32", 3/16", 7/32", 1/4", 9/32", 5/16", 11/32", 3/8", 7/16", 15/32"
- bussole esagonali attacco 1/2": 1/2", 9/16", 19/32", 5/8", 11/16", 3/4", 13/16", 7/8", 15/16", 1", 1-1/16", 1-1/8", 1-1/4"
- finitura satinata cromata
- zigrinate

POLLICI



BGS articolo	DESCRIZIONE	Euro
BGS 2434	SET 10 PEZZI, BUSSOLE, ATT. 1/2, IN POLLICI	31,11

CARATTERISTICHE

- esagonali
- 3/8", 7/16", 1/2", 9/16", 5/8", 11/16", 3/4", 13/16", 7/8", 15/16"
- finitura cromata satinata

RICAMBI

BGS articolo	DESCRIZIONE	Euro
BGS 2434-LEER	CASSETTA VUOTA	8,42



BGS articolo	DESCRIZIONE	Euro
BGS 2226	SET 16 PEZZI BUSSOLE POLIGONALI 8-24 MM FINITURA CROMATA SATINATA	40,04

CARATTERISTICHE

- misure: 8 - 9 - 10 - 11 - 12 - 13 - 14 - 15 - 16 - 17 - 18 - 19 - 20 - 21 - 22 - 24 mm

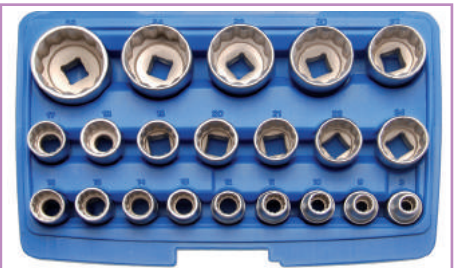

BGS articolo	DESCRIZIONE	Euro
BGS 2267	SET 21 PEZZI, BUSSOLE POLIGONALI ATT. 1/2", 8-36 MM	93,08

CARATTERISTICHE

- misure: 8 - 9 - 10 - 11 - 12 - 13 - 14 - 15 - 16 - 17 - 18 - 19 - 20 - 21 - 22 - 24 - 27 - 30 - 32 - 34 - 36 mm

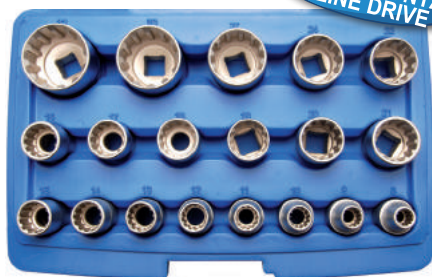
BUSSOLE
 MULTIMPRONTA
 SPLINE DRIVE

 1/2" MULTIMPRONTA
 SPLINE DRIVE

BGS articolo	DESCRIZIONE	Euro
BGS 2152	SET 19 PEZZI BUSSOLE "MULTIMPRONTA"	66,17

CARATTERISTICHE

- lo speciale profilo "multimpronta" consente l'uso universale con misure a esagono, poligonale, Torx, metrico e pollici
- 8 - 9 - 10 - 11 - 12 - 13 - 14 - 15 - 16 - 17 - 18 - 19 - 20 - 21 - 22 - 24 - 27 - 30 - 32 mm
- anche per bussole Torx (E10, E12, E14, E16, E18, E20, E22, E24), e misure in pollici (5/16", 11/32", 3/8", 7/16", 15/32", 1/2", 9/16", 19/32", 5/8", 3/4", 25/32", 13/16", 7/8", 15/16", 1-1/16", 1-3/16", 1-1/4")
- per bussole con esagono e poligonale

RICAMBI

BGS articolo	DESCRIZIONE	Euro
BGS 2152-LEER	CASSETTA VUOTA	12,24

1/2"

 ESAGONO

**BUSSOLE CHROM-VANADIUM SATINATE
 LUNGHE ESAGONO INTERNO PROFONDO**

 Attacco: 1/2"
 impronta: ESAGONO

BGS articolo	mm	L mm		Euro
BGS 9355	NEW 8	77	1	6,83
BGS 10550	10	77	1	6,83
BGS 10551	11	77	1	6,83
BGS 10552	12	77	1	6,83
BGS 10553	13	77	1	6,83
BGS 10554	14	77	1	7,14
BGS 10555	15	77	1	7,14
BGS 10556	16	77	1	7,14
BGS 10557	17	77	1	7,35
BGS 10558	18	77	1	7,88
BGS 10559	19	77	1	7,88
BGS 10560	20	77	1	8,24
BGS 10561	21	77	1	8,72
BGS 10562	22	77	1	9,24
BGS 10564	24	77	1	11,03
BGS 10566	NEW 26	77	1	11,03
BGS 10567	27	77	1	11,03
BGS 10568	NEW 28	77	1	11,03
BGS 10570	NEW 30	77	1	11,73
BGS 10572	NEW 32	77	1	12,62
BGS 9846	NEW 38	77	1	17,33

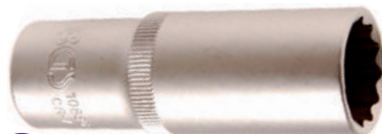

1/2"

 POLIGONALE

**BUSSOLE CHROM-VANADIUM POLIGONALI
 LUNGHE - SATINATE**

 Attacco: 1/2"
 impronta: POLIGONALI

BGS articolo	mm	L mm		Euro
BGS 9356	NEW 8	77	1	5,36
BGS 10680	10	77	1	5,10
BGS 9357	NEW 11	77	1	4,85
BGS 10662	12	77	1	4,85
BGS 10681	13	77	1	5,10
BGS 10664	14	77	1	5,10
BGS 10682	15	77	1	5,10
BGS 10683	16	77	1	5,10
BGS 10684	17	77	1	5,10
BGS 10685	18	77	1	5,61
BGS 10686	19	77	1	5,61
BGS 9359	NEW 20	77	1	6,12
BGS 9360	NEW 21	77	1	6,38
BGS 10687	22	77	1	6,89
BGS 10688	24	77	1	7,40
BGS 10663	NEW 26	77	1	8,16
BGS 9363	NEW 27	77	1	9,95
BGS 10689	NEW 28	77	1	8,93



1/2"

 SURFACE DRIVE

**BUSSOLE CHROM-VANADIUM - SATINATE
 LUNGHE - SURFACE DRIVE**

 Attacco: 1/2"
 impronta: SURFACE-DRIVE

BGS articolo	mm	L mm		Euro
BGS 10268	8	77	1	5,61
BGS 10270	10	77	1	5,61
BGS 10271	11	77	1	5,61
BGS 10272	12	77	1	5,61
BGS 2943	13	77	1	4,90
BGS 2944	14	77	1	4,90
BGS 2945	15	77	1	4,90
BGS 2946	16	77	1	4,90
BGS 2947	17	77	1	4,90
BGS 2948	18	77	1	5,23
BGS 2949	19	77	1	5,23
BGS 2951	21	77	1	6,38
BGS 2952	22	77	1	7,14
BGS 9361	NEW 24	77	1	7,40
BGS 9362	NEW 27	77	1	9,69
BGS 2956	NEW 28	77	1	8,93



1/2"

 TORX®

TORX® LUNGHE SATINATE

 Attacco: 1/2"
 impronta: TORX®

BGS articolo		L mm		Euro
BGS 6440	E 10	77	1	7,50
482-1177	E 11	77	1	8,40
BGS 6442	E 12	77	1	8,40
BGS 6444	E 14	77	1	8,65
BGS 6446	E 16	77	1	8,91
BGS 6448	E 18	77	1	9,16
BGS 6450	E 20	77	1	9,42

TORX®		S mm	S mm
E 4	3.70	E 16	14.60
E 5	4.60	E 18	16.50
E 6	5.60	E 20	18.30
E 7	6.10	E 22	20.10
E 8	7.40	E 24	22.00
E 10	9.30	E 26	23.70
E 11	9.90	E 28	25.50
E 12	11.00	E 30	27.30
E 14	12.80	E 32	29.00



BUSSOLE MULTIMPRONTA SPLINE DRIVE



1/2"

MULTIMPRONTA SPLINE DRIVE

mm Pollici Torx® XZN®

BUSSOLE CHROM-VANADIUM MULTIMPRONTA SPLINE-DRIVE

Attacco: 1/2"
impronta: SPLINE DRIVE

BGS articolo	mm	L mm		Euro
BGS 10254	14	77	1	5,48
BGS 10255	15	77	1	5,99
BGS 10256	16	77	1	5,99
BGS 10257	17	77	1	6,12
BGS 10258	18	77	1	6,25
BGS 10259	19	77	1	6,25



1/2" CV PRO+ ESAGONO

BGS articolo	DESCRIZIONE	Euro
BGS 2223	SET 9 PEZZI, BUSSOLE TIPO LUNGO	42,08

CARATTERISTICHE

- finitura satinata cromata, zigrinata
- esagonali
- misure: 10-13-15-16-17-18-19-22-24 mm



1/2" TORX® CV PRO+

BGS articolo	DESCRIZIONE	Euro
BGS 2026	SET 9 PEZZI, BUSSOLE TIPO LUNGO PER VITI TIPO TORX	50,86

CARATTERISTICHE

- finitura satinata cromata
- zigrinate
- Torx (lunghezza circa 80 mm) E 10 - 11 - 12 - 14 - 16 - 18 - 20 - 22 - 24

MILLIMETRI E POLLICI



PRO CV

BUSSELA UNIVERSALE

BGS articolo	PER MISURE	Euro
BGS 2533	3/8" 9-19 MM	16,58
BGS 2531	1/2" 11-30 MM	50,24

CARATTERISTICHE

- adatta a tutte le impronte esagonali anche in pollici



1/2" PRO+ CV POLIGONALE

BGS articolo	DESCRIZIONE	Euro
BGS 5253	SET 9 PEZZI, BUSSOLE TIPO LUNGO, POLIGONALI, ATT. 1/2"	44,63

CARATTERISTICHE

- misure: 10 - 13 - 15 - 16 - 17 - 18 - 19 - 22 - 24 mm
- finitura satinata cromata
- zigrinate
- con supporto in plastica

POLLICI



1/2" ESAGONO CV PRO+

BGS articolo	DESCRIZIONE	Euro
BGS 2435	SET 10 PEZZI BUSSOLE TIPO LUNGO	44,63

CARATTERISTICHE

- finitura esagonale
- 3/8", 7/16", 1/2", 9/16", 5/8", 11/16", 3/4" 13/16", 7/8", 15/16"
- finitura satinata cromata



CHIAVI APERTE A ZAMPA DI GALLO

attacco: 1/2"

articolo	mm		Euro
BGS 1757-20	20	1	9,31
BGS 1757-21	21	1	10,20
BGS 1757-22	22	1	10,46
BGS 1757-23	23	1	13,52
BGS 1757-24	24	1	13,52
BGS 1757-25	25	1	13,52
BGS 1757-26	26	1	13,52
BGS 1757-27	27	1	14,03
BGS 1757-28	28	1	14,03
BGS 1757-30	30	1	15,30
BGS 1757-32	32	1	16,83
BGS 1759-33	33	1	22,44
BGS 1759-36	36	1	22,95



PRO+

SET 13 PZ CHIAVI APERTE A ZAMPA DI GALLO

- 20, 21, 22, 23, 24, 25, 26, 27, 28, 30, 32, MM
- N. 1 PROLUNGA 1/2" L. 125 MM
- N. 1 IMPUGNATURA CON QUADRO SNODATO L. 385 MM

attacco: 1/2"

articolo	Descrizione		Euro
BGS 1757	SET 13 PEZZI	1	174,88
BGS 1757-LEER	CASSETTA VUOTA PER SET BGS 1757	1	16,58



PRO+

SET 8 PZ CHIAVI APERTE A ZAMPA DI GALLO

- 33, 36 MM, ATTACCO QUADRO 1/2"
- 38, 41, 46, 50 MM, ATTACCO QUADRO 3/4"
- N. 1 PROLUNGA 1/2" L. 125 MM
- N. 1 PROLUNGA 3/4" L. 100 MM

attacco: 1/2" - 3/4"

articolo	Descrizione		Euro
BGS 1759	SET 7 CHIAVI	1	258,75



articolo	DESCRIZIONE	Euro
BGS 9156	BUSSOLA PER TIRANTI, ATTACCO 1/2"	33,02

CARATTERISTICHE

- per la rimozione delle estremità dei tiranti
- per la maggior parte delle auto e alcuni camion
- dimensioni:
 - apertura: 18,5 x 34 mm
 - Ø interno: 49 mm
 - lunghezza: 57,5 mm
 - profondità: 40 mm



ESAGONO

CHIAVI A BUSSOLA MASCHIO ESAGONALI

Attacco: 1/2"

impronta: ESAGONO

articolo	mm	L mm		Euro
BGS 4250	4	55	1	7,35
BGS 4251	5	55	1	7,35
BGS 9467	NEW 5,5	55	1	7,35
BGS 4252	6	55	1	7,35
BGS 4253	7	55	1	7,35
BGS 4254	8	55	1	7,35
BGS 4340	9	55	1	7,35
BGS 4255	10	55	1	7,88
BGS 4256	12	55	1	7,88
455-1355	13	55	1	8,19
BGS 4257	14	55	1	8,19
BGS 5184-H17	17	55	1	8,19
BGS 5184-H19	19	55	1	10,50
BGS 5184-H22	22	55	1	12,08
BGS 5184-H24	24	55	1	13,13
BGS 5052-14	NEW 14	70	1	8,19
BGS 5052-16	NEW 16	70	1	8,19
BGS 5052-17	NEW 17	70	1	8,19
BGS 5052-18	NEW 18	70	1	10,50
BGS 5052-19	NEW 19	70	1	10,50
BGS 4295	NEW 22	70	1	12,08
BGS 4270	5	100	1	8,30
BGS 4271	6	100	1	8,30
BGS 4217	7	100	1	8,30
BGS 4272	8	100	1	8,30
BGS 5184-H10	10	100	1	8,30
BGS 5184-H11	11	100	1	8,30
BGS 4273	12	100	1	8,93
BGS 5184-H13	13	100	1	9,45
BGS 4296	NEW 14	100	1	9,45
458-0514	5	140	1	10,50
458-0614	6	140	1	10,50
458-0714	7	140	1	10,50
458-0814	8	140	1	10,50
458-1014	10	140	1	10,50
458-1114	11	140	1	10,50
458-1214	12	140	1	11,55
458-1314	13	140	1	11,55
BGS 4274	14	140	1	11,55
BGS 4275	5	200	1	13,65
BGS 4276	6	200	1	13,65
BGS 4277	7	200	1	13,65
BGS 4278	8	200	1	13,65
BGS 4279	10	200	1	13,65
BGS 4280	12	200	1	13,65
BGS 4215	5	240	1	15,75
BGS 4216	6	240	1	15,75
BGS 5184-H7	7	240	1	15,75
BGS 4218	8	240	1	15,75



 1/2"  **ESAGONO**

CHIAVI A BUSSOLA MASCHIO ESAGONALI TESTA SFERICA

Attacco: 1/2"
impronta: ESAGONO

articolo	mm	L mm		Euro
459-0510	5	100	1	11,55
459-0610	6	100	1	11,55
459-0810	8	100	1	11,55
459-1010	10	100	1	11,55
BGS 4258-5	5	140	1	12,60
BGS 4258-6	6	140	1	12,60
NEW BGS 4258-7	7	140	1	12,60
BGS 4258-8	8	140	1	12,60
BGS 4258-10	10	140	1	12,60
BGS 4258-12	12	140	1	12,60
BGS 5184-HB5	5	160	1	15,75



NEW

 1/2"  22 mm  **TORX®**



BGS articolo	DESCRIZIONE	Euro
BGS 9532	BUSSOLA PER CINGHIE A V, ATT. 1/2", TORX TX60	14,56

CARATTERISTICHE

- bussola speciale per motori TDI common rail VAG 6 cilindri per il rilascio della cinghia a V
- per uso come OEM T40087
- manovra:
 - quadro femmina: 1/2"
 - esagono: 22 mm



TORX®		S mm	S mm
T 6	1.70	T 40	6.70
T 7	2.00	T 45	7.90
T 8	2.30	T 50	8.90
T 9	2.50	T 55	11.30
T 10	2.70	T 60	13.30
T 15	3.30	T 70	15.60
T 20	3.90	T 80	17.60
T 25	4.50	T 90	20.00
T 27	5.00	T 100	22.20
T 30	5.60		



 1/2"  **TORX®**

CHIAVI A BUSSOLA TORX®

Attacco: 1/2"
impronta: TORX®



articolo		L mm		Euro
BGS 4368	NEW TX 15	55	1	8,40
BGS 4369	TX 20	55	1	8,40
BGS 4370	TX 25	55	1	8,40
BGS 4367	TX 27	55	1	8,40
BGS 4371	TX 30	55	1	8,40
BGS 9627	NEW TX 35	55	1	8,40
BGS 4372	TX 40	55	1	8,93
BGS 4373	TX 45	55	1	8,93
BGS 4374	TX 50	55	1	8,93
BGS 4375	TX 55	55	1	9,98
BGS 4378	TX 60	55	1	10,50
BGS 4379	TX 70	55	1	13,65
BGS 4468	NEW TX 15	100	1	8,40
BGS 4469	TX 20	100	1	8,93
BGS 4470	TX 25	100	1	8,93
BGS 4467	TX 27	100	1	8,93
BGS 4471	TX 30	100	1	8,93
BGS 9628	NEW TX 35	100	1	8,93
BGS 4472	TX 40	100	1	9,45
BGS 4473	TX 45	100	1	9,45
BGS 4474	TX 50	100	1	9,45
BGS 4475	TX 55	100	1	11,55
BGS 4476	TX 60	100	1	11,55
BGS 4477	TX 70	100	1	16,80
4705-8010	TX 80	100	1	21,00
4705-9010	TX 90	100	1	30,45
4705-10010	TX 100	100	1	37,80
BGS 9364	NEW TX 25	140	1	12,60
BGS 9348	NEW TX 27	140	1	12,60
BGS 5184-T40	TX 40	140	1	12,60
BGS 5184-T45	TX 45	140	1	12,60
BGS 5184-T50	TX 50	140	1	12,60
BGS 5184-T55	TX 55	140	1	13,65
BGS 5184-T60	TX 60	140	1	13,65
BGS 5184-T70	TX 70	140	1	16,80
471-8014	TX 80	140	1	23,10
471-9014	TX 90	140	1	33,60
471-10014	TX 100	140	1	38,85
BGS 9365	NEW TX 25	200	1	15,75
471-3020	TX 30	200	1	15,75
BGS 4480	TX 40	200	1	15,75
BGS 4481	TX 45	200	1	15,75
BGS 4482	TX 50	200	1	15,75
BGS 4483	TX 55	200	1	16,80
BGS 4484	TX 60	200	1	16,80
BGS 4485	TX 70	200	1	19,95
474-4014	TH 40	140	1	13,65
474-4514	TH 45	140	1	13,65
474-5014	TH 50	140	1	13,65
474-5514	TH 55	140	1	14,70
474-6014	TH 60	140	1	14,70
474-7014	TH 70	140	1	16,80
474-8014	TH 80	140	1	25,20
474-9014	TH 90	140	1	34,65
474-10014	TH 100	140	1	39,90
4742-4020	TH 40	200	1	21,00
4742-4520	TH 45	200	1	22,05
4742-5020	TH 50	200	1	25,20
BGS 5184-TB30	TH 30	300	1	27,30



 1/2"  **TORX® CON FORO**

CHIAVI A BUSSOLA TORX® C/FORO

Attacco: 1/2"
impronta: TORX® C/FORO

articolo		L mm		Euro
472-2055	TH 20	55	1	10,50
472-2555	TH 25	55	1	10,50
472-2755	TH 27	55	1	10,50
472-3055	TH 30	55	1	10,50
BGS 4326	TH 40	55	1	11,55
BGS 4327	TH 45	55	1	11,55
BGS 4328	TH 50	55	1	11,55
BGS 4329	TH 55	55	1	13,65
BGS 4376	TH 60	55	1	13,65
BGS 4377	TH 70	55	1	13,65
473-2010	TH 20	100	1	11,55
473-2510	TH 25	100	1	11,55
473-2710	TH 27	100	1	11,55
473-3010	TH 30	100	1	11,55
473-4010	TH 40	100	1	12,60
473-4510	TH 45	100	1	12,60
473-5010	TH 50	100	1	12,60
473-5510	TH 55	100	1	14,70
473-6010	TH 60	100	1	14,70
473-7010	TH 70	100	1	16,80
BGS 5184-TB80	TH 80	100	1	23,10
473-9010	TH 90	100	1	31,50
473-10010	TH 100	100	1	37,80
NEW BGS 5103-TB70	TH 70	110	1	16,80
NEW BGS 5103-TB80	TH 80	110	1	23,10
NEW BGS 5103-TB90	TH 90	110	1	31,50
NEW BGS 5103-TB100	TH 100	110	1	37,80
474-4014	TH 40	140	1	13,65
474-4514	TH 45	140	1	13,65
474-5014	TH 50	140	1	13,65
474-5514	TH 55	140	1	14,70
474-6014	TH 60	140	1	14,70
474-7014	TH 70	140	1	16,80
474-8014	TH 80	140	1	25,20
474-9014	TH 90	140	1	34,65
474-10014	TH 100	140	1	39,90
4742-4020	TH 40	200	1	21,00
4742-4520	TH 45	200	1	22,05
4742-5020	TH 50	200	1	25,20
BGS 5184-TB30	TH 30	300	1	27,30

1/2"





1/2"



RIBE

CHIAVI A BUSSOLA RIBE®

 Attacco: 1/2"
 impronta: RIBE®

#FERMEC articolo		L mm		Euro
BGS 4150	NEW M 5	55	1	9,45
BGS 4151	NEW M 6	55	1	9,45
BGS 4152	NEW M 7	55	1	9,45
BGS 4153	NEW M 8	55	1	9,45
BGS 4154	NEW M 9	55	1	9,45
BGS 4155	NEW M 10	55	1	9,45
BGS 9353	NEW M 10.3	55	1	9,00
BGS 4156	NEW M 12	55	1	10,50
BGS 4157	NEW M 13	55	1	10,50
BGS 4158	NEW M 14	55	1	10,50

4782-0005	M 5	63	1	9,45
4782-0006	M 6	63	1	9,45
4782-0007	M 7	63	1	9,45
4782-0008	M 8	63	1	9,45
4782-0009	M 9	63	1	9,45
4782-0010	M 10	63	1	9,45
4782-0012	M 12	63	1	10,50
4782-0013	M 13	63	1	10,50
4782-0014	M 14	63	1	10,50
4782-0016	M 16	63	1	11,55
4782-0018	M 18	63	1	15,75
4782-0020	M 20	63	1	16,80

BGS 4160	M 5	100	1	10,50
BGS 4161	M 6	100	1	10,50
BGS 4162	M 7	100	1	10,50
BGS 4163	M 8	100	1	10,50
BGS 5184-R9	M 9	100	1	10,50
BGS 4165	M 10	100	1	10,50
BGS 4166	M 12	100	1	11,55
BGS 4167	M 13	100	1	11,55
BGS 4168	M 14	100	1	13,65
4784-0016	M 16	100	1	15,75

BGS 4234	M 7	140	1	17,85
BGS 4173	M 8	140	1	17,85
BGS 4174	M 9	140	1	17,85
BGS 5184-R10	M 10	140	1	17,85
BGS 4179	NEW M 10.3	140	1	17,85
BGS 4176	M 12	140	1	19,95
BGS 4177	M 13	140	1	23,10
BGS 4178	M 14	140	1	24,15

4788-0007	M 7	200	1	22,05
BGS 4183	M 8	200	1	22,05
BGS 4184	M 9	200	1	22,05
BGS 4189	M 10	200	1	22,05
BGS 4185	NEW M 10.3	200	1	22,05
BGS 4186	M 12	200	1	25,20
BGS 4187	M 13	200	1	25,20
BGS 4188	M 14	200	1	25,20

BGS 5184-R7	M 7	240	1	27,30
BGS 5184-R8	M 8	240	1	27,30

RIBE

S
mmW
mm

M 5 5.00 1.20

M 6 6.00 1.30

M 7 7.00 1.40

M 8 8.00 1.80

M 9 9.00 2.00

M 10 10.00 2.30

M 12 12.00 2.60

M 13 13.00 3.10

M 14 14.00 3.20



M 16 16.00 3.60



1/2"

RIBE
CON FORO
CHIAVI A BUSSOLA RIBE® C/FORO

 Attacco: 1/2"
 impronta: RIBE® C/FORO

#FERMEC articolo		L mm		Euro
4783-0005	M 5	63	1	11,55
4783-0006	M 6	63	1	11,55
4783-0007	M 7	63	1	11,55
4783-0008	M 8	63	1	11,55
4783-0009	M 9	63	1	11,55
4783-0010	M 10	63	1	11,55
4783-0012	M 12	63	1	11,55
4783-0013	M 13	63	1	11,55
4783-0014	M 14	63	1	12,60
4783-0016	M 16	63	1	13,65



4785-0005	M 5	100	1	12,60
4785-0006	M 6	100	1	12,60
4785-0007	M 7	100	1	12,60
4785-0008	M 8	100	1	12,60
4785-0009	M 9	100	1	12,60
4785-0010	M 10	100	1	12,60
4785-0012	M 12	100	1	13,65
4785-0013	M 13	100	1	13,65
4785-0014	M 14	100	1	14,70
4785-0016	M 16	100	1	16,80



1/2"

XZN
CON FORO
CHIAVI A BUSSOLA XZN®

 Attacco: 1/2"
 impronta: XZN®

#FERMEC articolo		L mm		Euro
4751-1455	M 14	55	1	13,65
BGS 4356	M 16	55	1	13,65
BGS 4357	M 16	100	1	16,80
BGS 4365	M 18	100	1	17,85





1/2"



XZN

CHIAVI A BUSSOLA XZN®

 Attacco: 1/2"
 impronta: XZN®

#FERMEC articolo		L mm		Euro
BGS 4350	M 5	55	1	9,45
BGS 4351	M 6	55	1	9,45
BGS 4355	M 7	55	1	9,45
BGS 4352	M 8	55	1	9,45
BGS 4349	M 9	55	1	9,45
BGS 4353	M 10	55	1	9,45
BGS 4354	M 12	55	1	10,50
BGS 4344	M 14	55	1	10,50
BGS 4346	M 16	55	1	11,55
BGS 5180-M17	M 17	55	1	12,60
BGS 4347	M 18	55	1	11,55

BGS 4359	M 5	100	1	10,50
BGS 4360	M 6	100	1	10,50
476-0710	M 7	100	1	10,50
BGS 4361	M 8	100	1	10,50
BGS 5184-M9	M 9	100	1	11,55
BGS 4362	M 10	100	1	11,55
BGS 4363	M 12	100	1	13,65
BGS 4364	M 14	100	1	15,75
476-1610	M 16	100	1	15,75
BGS 5184-M18	M 18 BRUNITA	78	1	12,00

BGS 4330	M 5	140	1	11,55
BGS 4331	M 6	140	1	11,55
BGS 4432	M 7	140	1	11,55
BGS 4332	M 8	140	1	11,55
BGS 4333	M 9	140	1	11,55
BGS 5184-M10	M 10	140	1	12,60
BGS 5184-M12	M 12	140	1	13,65
BGS 5184-M14	M 14	140	1	14,70

BGS 4334	M 8	200	1	15,75
BGS 4335	M 10	200	1	15,75
BGS 4336	M 12	200	1	15,75
BGS 4337	M 14	200	1	15,75

BGS 4227	M 8	800	1	32,55
BGS 4228	M 10	800	1	33,60
BGS 4229	M 12	800	1	34,65
BGS 4233	M 14	800	1	35,70

XZN

S
mmS
mm

M 4 3,60 M12 11,50

M 5 4,80 M14 13,30

M 6 6,10 M16 15,70

M 8 7,30 M18 16,90

M10 9,70





ESAGONO TORX® XZN ESAGONO



BGS articolo	DESCRIZIONE	Euro
BGS 4095	ESPOSITORE 315 PEZZI, PER LA VENDITA, CON DOTAZIONE COMPLETA DI BUSSOLE & CHIAVI A BUSSOLA	1025,00

CARATTERISTICHE

- set 315 pezzi bussole e chiavi a bussola att. 1/2"
- finitura cromata satinata, zigrinate
- chiavi a bussola con esagono maschio, lungh. 100 mm (7 pz. per ciascun formato): 7 - 8 - 10 - 12 mm
- chiavi a bussola XZN maschio, lungh. 100 mm (7 pz. per ciascun formato): M8 - M10 - M12 - M14
- chiavi a bussola Torx maschio, lungh. 100 mm (7 pz. per ciascun formato): TX25 - TX30 - TX40 - TX45 - TX50
- bussole esagonali (pezzi per ciascuna misura): 8 mm (10 pz.), 9 mm (10 pz.), 10 mm (20 pz.), 11 mm (10 pz.), 12 mm (10 pz.), 13 mm (20 pz.), 14 mm (10 pz.), 15 mm (10 pz.), 16 mm (10 pz.), 17 mm (20 pz.), 18 mm (8 pz.), 19 mm (20 pz.), 21 mm (15 pz.), 22 mm (15 pz.), 24 mm (10 pz.), 27 mm (8 pz.), 30 mm (8 pz.), 32 mm (10 pz.)
- dimensioni dell'espositore: (prof. x largh. x altezza pz.) 335 x 410 x 270 mm

RICAMBI

BGS articolo	DESCRIZIONE	Euro
BGS 4095-2	ESPOSITORE VUOTO	287,50



1/2" ESAGONO

CASSETTA CHIAVI A BUSSOLA MASCHIO ESAGONALI
• 5-6-7-8-10-12-14-16-17-18-19-22 MM L. 60/70 MM

FEW articolo	Descrizione	Euro
50522	CASSETTA 12 PEZZI	83,48



1/2" ESAGONO PRO+ CV

BGS articolo	DESCRIZIONE	Euro
BGS 5053	SET 12 PEZZI, CHIAVI A BUSSOLA ESAGONALI IN POLLICI, 7/32" - 3/4"	71,15

CARATTERISTICHE

- comprende:
 - bussole lunghezza 55 mm: 7/32" - 1/4" - 9/32" - 5/16" - 3/8" - 15/32"
 - bussole lunghezza 70 mm: 9/16" - 5/8" - 11/16" - 13/16" - 3/4"
- finitura satinata cromata
- zigrinate



1/2" ESAGONO

CASSETTA CHIAVI A BUSSOLA MASCHIO ESAGONALI BRUGOLA IN POLLICI
• 5/32"-3/16"-7/32"-1/4"-5/16"-3/8"-7/16"-1/2"-9/16" - LUNGH. 55 MM

FEW articolo	pollici	L mm	Euro
40902-5/32	5/32"	55	12,08
40902-3/16	3/16"	55	12,08
40902-7/32	7/32"	55	12,60
40902-1/4	1/4"	55	12,60
40902-5/16	5/16"	55	13,13
40902-3/8	3/8"	55	13,65
40902-7/16	7/16"	55	14,28
40902-1/2	1/2"	55	15,54
40902-9/16	9/16"	55	16,80
40902	CASSETTA 9 PEZZI	1	84,00





ESAGONO



PRO+



BGS articolo	DESCRIZIONE	Euro
BGS 4258	SET 6 PEZZI CHIAVI A BUSSOLA ESAGONALI TESTA SFERICA	45,77

CARATTERISTICHE

- 5-6-7-8-10-12 mm
- lunghezza 140 mm

RICAMBI

BGS articolo	descrizione	Euro
BGS 4258-5	BUSSOLA 5 MM	12,60
BGS 4258-6	BUSSOLA 6 MM	12,60
BGS 4258-7	BUSSOLA 7 MM	12,60
BGS 4258-8	BUSSOLA 8 MM	12,60
BGS 4258-10	BUSSOLA 10 MM	12,60
BGS 4258-12	BUSSOLA 12 MM	12,60

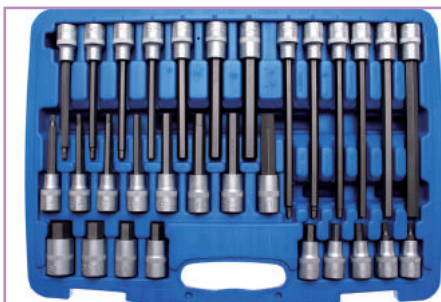

ESAGONO

PRO+



BGS articolo	DESCRIZIONE	Euro
BGS 5181	SET 30 PEZZI CHIAVI A BUSSOLA ESAGONALI ASSORTITE	154,88

CARATTERISTICHE

- inserti corti acciaio S2
- comprende:
 - lunghezza 55 mm: 5-6-7-8-10-12-14-17-19 mm
 - lunghezza 100 mm: 5-6-7-8-10-11-12-13 mm
 - lunghezza 140 mm: 5-6-7-8-10-12-14 mm
 - lunghezza 200 mm: 5-6-7-8-10-12 mm

RICAMBI

BGS articolo	DESCRIZIONE	Euro
BGS 5181-LEER	CASSETTA VUOTA	24,74



PRO+



ESAGONO

BGS articolo	DESCRIZIONE	Euro
BGS 8887	SERIE 6 PEZZI, BUSSOLE ATTACCO QUADRO 1/2", ESAGONO MASCHIO 6-14 MM	24,23

CARATTERISTICHE

- misure: 6 - 7 - 8 - 10 - 12 - 14 mm
- attacco quadro 1/2"
- ziggrinate
- finitura cromata satinata



-3/8"

-1/2"

ESAGONO



PRO+

BGS articolo	DESCRIZIONE	Euro
BGS 5099	SET 10 PEZZI, CHIAVI A BUSSOLA ESAGONALI EXTRA CORTE, 4 - 19 MM	30,60

CARATTERISTICHE

- attacco 1/4", lunghezza 30 mm: 4 - 5 - 6 - 7 - 8 mm
- attacco 3/8", lunghezza 38 mm: 10 - 12 - 14 mm
- attacco 1/2", lunghezza 48 mm: 17 - 19 mm
- ziggrinate
- finitura cromata satinata
- su guida metallica

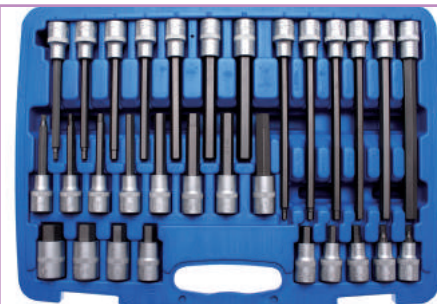

TORX®

PRO+



BGS articolo	DESCRIZIONE	Euro
BGS 5182	SET 32 PEZZI, CHIAVI A BUSSOLA TORX ASSORTITE	162,38

CARATTERISTICHE

- inserti corti acciaio S2
- comprende:
 - lunghezza 55 mm: TX20-TX25-TX27-TX30-TX40 TX45-TX50-TX55-TX60-TX70
 - lunghezza 100 mm: TX20-TX25-TX27-TX30-TX40 TX45-TX50-TX55-TX60-TX70
 - lunghezza 140 mm: TX40-TX45-TX50-TX55-TX60-TX70
 - lunghezza 200 mm: TX40-TX45-TX50-TX55-TX60-TX70



TORX® TORX®

- 9 BUSSOLE TORX® FEMMINA
- E 10-11-12-14-16-18-20-22-24
- 10 BUSSOLE CON INSERTI TORX®
- T 20-25-27-30-40-45-50-55-60-70

 attacco: 1/2"
 impronta: TORX®

BGS articolo	Descrizione	Euro
54019	CASSETTA PLASTICA 19 PEZZI	57,75



BGS articolo	DESCRIZIONE	Euro
BGS 95100	SET 19 PEZZI, BUSSOLE TORX FEMMINA E BUSSOLE CON INSERTI TORX	41,34

CARATTERISTICHE

- comprende le seguenti bussole Torx femmina: E10, E11, E12, E14, E16, E18, E20, E22, E24
- comprende le seguenti bussole con inserti Torx: TX20, TX25, TX27, TX30, TX40, TX45, TX50, TX55, TX60, TX70
- finitura cromata satinata



BGS articolo	DESCRIZIONE	Euro
BGS 5098	SET 12 PEZZI, CHIAVI A BUSSOLA TORX® EXTRA CORTE, T8 - T60	28,05

CARATTERISTICHE

- attacco 1/4", lunghezza 30 mm: T8 - T10 - T15 - T20 - T25 - T27
- attacco 3/8", lunghezza 38 mm : T30 - T40 - T45 - T50 - T55
- attacco 1/2", lunghezza 48 mm: T60
- zigrinate
- finitura cromata satinata
- su guida metallica



BGS articolo	DESCRIZIONE	Euro
BGS 5101	SET 27 PEZZI, INSERTI E CHIAVI A BUSSOLA TORX	55,46

CARATTERISTICHE

- durezza e coppia in conformità con le norme tedesche DIN
- 5 chiavi a bussola attacco da 1/2": T45-50-55-60-70
- 7 inserti per viti Torx: T10-15-20-25-27-30-40
- 12 inserti per viti Torx c/foro: T10-15-20-25-27-30-40-45-50-55-60-70
- 3 adattatori per inserti attacco da 1/4" - 3/8" - 1/2"



BGS articolo	DESCRIZIONE	Euro
BGS 8886	SERIE 6 PEZZI, BUSSOLE ATTACCO QUADRO 1/2", TORX TX40-TX55	16,58

CARATTERISTICHE

- misure: Tx40 - Tx45 - Tx50 - Tx55
- attacco quadro 1/2"
- zigrinate
- finitura cromata satinata



CASSETTA CHIAVI A BUSSOLA TORX® CON FORO

- N. 10 T20, T25, T27, T30, T40, T45, T50, T55, T60, T70 - L. 55 MM
- N. 10 T20, T25, T27, T30, T40, T45, T50, T55, T60, T70 - L. 100 MM
- N. 6 T40, T45, T50, T55, T60, T70 L. 140 MM
- N. 6 T40, T45, T50, T55, T60, T70 L. 200 MM

attacco: 1/2"
impronta: TORX® CON FORO

BGS articolo	Descrizione	Euro
4203	CASSETTA PLASTICA 32 PEZZI	136,50



BGS articolo	DESCRIZIONE	Euro
BGS 8885	SERIE 6 PEZZI, BUSSOLE ATTACCO QUADRO 1/2", TORX CON FORO TH40-TH55	16,58

CARATTERISTICHE

- misure: Th40 - Th45 - Th50 - Th55
- attacco quadro 1/2"
- zigrinate
- finitura cromata satinata

TORX®	S mm	S mm	
T 6	1.70	T 40	6.70
T 7	2.00	T 45	7.90
T 8	2.30	T 50	8.90
T 9	2.50	T 55	11.30
T 10	2.70	T 60	13.30
T 15	3.30	T 70	15.60
T 20	3.90	T 80	17.60
T 25	4.50	T 90	20.00
T 27	5.00	T 100	22.20
T 30	5.60		

0 1/2"



BGS articolo	DESCRIZIONE	Euro
BGS 5103	SET 4 PEZZI, CHIAVI A BUSSOLA TORX C/FORO	45,14

CARATTERISTICHE

- TH70 (testa cilindri di molte marche, vasca filtro olio)
- TH80 (assemblaggio braccio tergicristalli, MAN, serie M)
- TH90 (bulloni per testata cilindri)
- TH100 (leva dello sterzo, MAN, serie F)
- idonee per l'assemblaggio di bulloni per testata cilindri di Ford, BMW, Citroen, Renault, Audi, Mercedes)

RICAMBI

BGS articolo	DESCRIZIONE	Euro
BGS 5103-TB70	TH 70	16,80
BGS 5103-TB80	TH 80	23,10
BGS 5103-TB90	TH 90	31,50
BGS 5103-TB100	TH 100	37,80
BGS 5103-LEER	CASSETTA VUOTA	8,67



BGS 2020



BGS articolo	DESCRIZIONE	Euro
BGS 2028	SET 6 PEZZI BUSSOLE TIPO TORX EXTRA LUNGO	90,53

CARATTERISTICHE

- E 10 - 12 - 14 - 16 - 18 - 20
- lunghezza: 140 mm
- con sfera di bloccaggio

RICAMBI

BGS articolo	DESCRIZIONE	Euro
BGS 2020	BUSSOLA E12X150 MM PER TESTATE BMW	13,26



BGS articolo	DESCRIZIONE	Euro
BGS 1112	SET 3 PEZZI, BUSSOLE PENTAGONALI, ATTACCO 1/2"	19,13

CARATTERISTICHE

- acciaio al cromo vanadio
- bussola pentagonale da 14 mm idonea per Opel / Vauxhall (Astra G, Zafira), Smart
- bussola speciale per freni Girling
- bussola pentagonale da 19 mm idonea per Peugeot, Renault

PENTALOBATA	S mm	S mm
8 PR	2.20	27 PR 4.70
9 PR	2.40	30 PR 5.20
10 PR	2.60	40 PR 6.30
15 PR	3.10	45 PR 7.40
20 PR	3.60	50 PR 8.40
25 PR	4.10	55 PR 10.60



BGS articolo	DESCRIZIONE	Euro
BGS 5190	SET 32 PEZZI, BUSSOLE ATT. 1/2", TORX PLUS	188,75

CARATTERISTICHE

- zigrinate
- per Torx Plus
- comprende:
 - lunghezza 55 mm: TS20, TS25, TS27, TS30, TS40, TS45, TS50, TS55, TS60, TS70
 - lunghezza 100 mm: TS20, TS25, TS27, TS30, TS40, TS45, TS50, TS55, TS60, TS70
 - lunghezza 140 mm: TS40, TS45, TS50, TS55, TS60, TS70
 - lunghezza 200 mm: TS40, TS45, TS50, TS55, TS60, TS70



BGS articolo	DESCRIZIONE	Euro
BGS 5191	SET 32 PEZZI, BUSSOLE ATT. 1/2", 5 PUNTE CON FORO	206,25

CARATTERISTICHE

- zigrinate
- per 5 punte con foro
- comprende:
 - lunghezza 55 mm: TP20, TP25, TP27, TP30, TP40, TP45, TP50, TP55, TP60, TP70
 - lunghezza 100 mm: TP20, TP25, TP27, TP30, TP40, TP45, TP50, TP55, TP60, TP70
 - lunghezza 140 mm: TP40, TP45, TP50, TP55, TP60, TP70
 - lunghezza 200 mm: TP40, TP45, TP50, TP55, TP60, TP70



RIBE XZN TORX® TORX®

1/2" PRO+ CV

BGS articolo	DESCRIZIONE	Euro
BGS 5014	SET 9 PEZZI, CHIAVI A BUSSOLA SPECIALI PER TESTATE CILINDRI	105,83

CARATTERISTICHE

- inserti con finitura nera

RICAMBI

BGS articolo	DESCRIZIONE	Euro
BGS 5003	TORX 70 X 120 MM	9,44
BGS 5007	RIBE 13 X 120 MM	8,93
BGS 5009	XZN 10 X 140 MM	7,40
BGS 5010	RIBE 12 X 120 MM	7,65

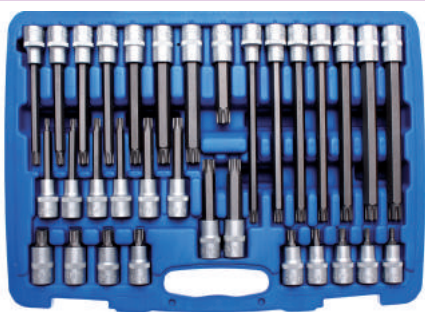

1/2" RIBE PRO+ CV

BGS articolo	DESCRIZIONE	Euro
BGS 5183	SET 32 PEZZI, CHIAVI A BUSSOLA RIBE ASSORTITE	169,88

CARATTERISTICHE

- inserti corti acciaio S2
- comprende:
 - lunghezza 55 mm: M 5-6-7-8-9-10-12-13-14
 - lunghezza 100 mm: M 5-6-7-8-9-10-12-13-14
 - lunghezza 140 mm: M 8-9-10-10.3-12-13-14
 - lunghezza 200 mm: M 8-9-10-10.3-12-13-14



3/8" 1/2" RIBE PRO+ CV

BGS articolo	DESCRIZIONE	Euro
BGS 5185	SET 7 PEZZI, CHIAVI A BUSSOLA RIBE MASCHIO	33,02

CARATTERISTICHE

- Ribe: M6, M7, M8, M10 con attacco 3/8"
- Ribe: M12, M13, M14 con attacco 1/2"
- in acciaio al cromo vanadio
- satinato, zigrinate
- lunghezza: 75 mm
- su guida

RIBE	S mm	W mm
M 5	5.00	1.20
M 6	6.00	1.30
M 7	7.00	1.40
M 8	8.00	1.80
M 9	9.00	2.00
M 10	10.00	2.30
M 12	12.00	2.60
M 13	13.00	3.10
M 14	14.00	3.20
M 16	16.00	3.60



1/2" PRO+ CV XZN

BGS articolo	DESCRIZIONE	Euro
BGS 8449	SET 5 PEZZI, BUSSOLE MASCHIO XZN	42,08

CARATTERISTICHE

- inserti corti acciaio S2
- comprende
 - M 12 x 55 mm
 - M 9 x 100 mm
 - M 10 x 140 mm
 - M 12 x 140 mm
 - M 14 x 140 mm

PROMO



1/2" XZN PRO+ CV

BGS articolo	DESCRIZIONE	Euro
BGS 5180	SET 26 PEZZI, CHIAVI A BUSSOLA XZN ASSORTITE	144,88

CARATTERISTICHE

- inserti corti acciaio S2
- comprende:
 - lunghezza 55 mm: M 5-6-8-9-10-12-14-16
 - lunghezza 100 mm: M 5-6-8-9-10-12-14
 - lunghezza 140 mm: M 5-6-8-9-10-12-14
 - lunghezza 200 mm: M 8-10-12-14

XXL



1/2" XZN PRO+ CV

BGS articolo	DESCRIZIONE	Euro
BGS 4224	SET 3 PEZZI, BUSSOLE CON INSERTO PER ALBERO MOTORE DA 1/2", 800 MM	117,17

CARATTERISTICHE

- idoneo per viti albero motore
- non vi è necessità di barre di prolunga
- idoneo per VW e altre marche
- M8 x 800 mm, M10 e M12 x 800 mm

XZN	S mm	S mm	
M 4	3,60	M12	11,50
M 5	4,80	M14	13,30
M 6	6,10	M16	15,70
M 8	7,30	M18	16,90
M10	9,70		

1/2"



1/4"-3/8"-1/2"



PRO+

BGS
articolo

DESCRIZIONE

Euro

BGS 5105

SET 8 PEZZI, BUSSOLE
XZN

21,17

CARATTERISTICHE

- comprende:
 - attacco 1/4": M4-M5-M6
 - attacco 3/8": M8-10-12
 - attacco 1/2": M-14-16
- finitura cromata satinata
- su guida metallica

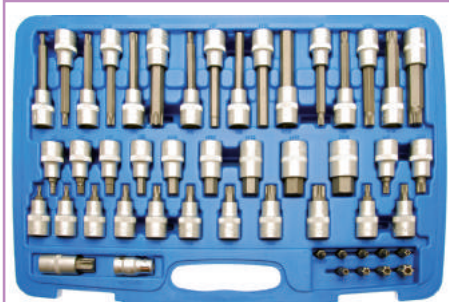



TORX®
CON FORO TORX® **ESAGONO** **XZN**

1/2"

PRO+

BGS
articolo

DESCRIZIONE

Euro

BGS 5188

SET CHIAVI A BUSSOLA
ATT. 1/2"

167,38

CARATTERISTICHE

- comprende i seguenti utensili attacco 1/2":
 - chiavi a bussola Torx maschio, lungh. 55 mm: TX20-TX25-TX27-TX30-TX40-TX45-TX50-TX55-TX60-TX70
 - chiavi a bussola Torx maschio, lungh. 100 mm: TX25 - TX30 - TX40 - TX45 - TX50 - TX60
 - chiavi a bussola Esagono maschio, lungh. 55 mm: 5 - 6 - 7 - 8 - 10 - 12 - 14 - 17 - 19 mm
 - chiavi a bussola Esagono maschio, lungh. 100 mm: 6 - 7 - 8 - 10 - 12 mm
 - chiavi a bussola XZN maschio, lungh. 55 mm: M5 - M6 - M8 - M10
 - chiavi a bussola XZN maschio, lungh. 100 mm: M6 - M8 - M10 - M12 - M14
 - inserti Torx con foro, lungh. 30 mm: TH20 - TH25 - TH27 - TH30 - TH40 - TH45 - TH50 - TH55 - TH60
 - bussola portainseriti att. 1/2"

Set che comprende:

- 1 Cassetta chiavi a bussola Esagonali



ESAGONO

- 1 cassetta chiavi a bussola Torx



TORX®

- 1 Cassetta chiavi a bussola XZN



XZN



1/2"

BGS
articolo

DESCRIZIONE

Euro

BGS 5186

SET 88 PEZZI,
CHIAVI A BUSSOLA
ESAGONALI, TORX E
XZN

324,88

CARATTERISTICHE

- cassetta chiavi a bussola Esagonali:
 - lunghezza 55 mm: 5-6-7-8-10-12-14-17-19 mm
 - lunghezza 100 mm: 5-6-7-8-10-11-12-13 mm
 - lunghezza 140 mm: 5-6-7-8-10-12-14 mm
 - lunghezza 200 mm: 5-6-7-8-10-12 mm
- cassetta chiavi a bussola Torx:
 - lunghezza 55 mm TX: 20-25-27-30-40-45-50-55-60-70
 - lunghezza 100 mm TX: 20-25-27-30-40-45-50-55-60-70
 - lunghezza 140 mm TX: 40-45-50-55-60-70
 - lunghezza 200 mm TX: 40-45-50-55-60-70
- cassetta chiavi a bussola XZN:
 - lungh. 55 mm: M5-M6-M8-M9-M10-M12-M14-M16
 - lunghezza 100 mm: M5-M6-M8-M9- M10-M12-M14
 - lunghezza 140 mm: M5-M6-M8-M9- M10-M12-M14
 - lunghezza 200 mm: M8-M10-M12-M14

DISPONIBILI
TUTTI I RICAMBI

1/2"



TORX® TORX® RIBE
CASSETTA CHIAVI A BUSSOLA M/F TORX®
E RIBE®

- N. 9 BUSSOLE TORX® FEMMINA E 10-11-12-14-16-18-20-22-24
- N. 18 CHIAVI A BUSSOLA RIBE® M 5-6-7-8-9-10-12-13-14 L. 55
- M 5-6-7-8-9-10-12-13-14 L. 100
- N. 10 CHIAVI A BUSSOLA TORX® MASCHIO T 20-25-27-30-40-45-50-55-60-70 L. 55

attacco: 1/2"

impronta: RIBE® - TORX®

BGS
articolo

Descrizione



Euro

3704

CASSETTA PLASTICA
37 PEZZI

1

136,50



1/4" 3/8" 1/2"

FEFMEC articolo	DESCRIZIONE	Euro
483814	SET 3 PEZZI, ADATTATORI DOPPIO QUADRO	12,60

CARATTERISTICHE

- comprende i seguenti adattatori con doppia sfera:
 - 1/4" M - 1/4" F, lunghezza 20 mm, art. 2841
 - 3/8" M - 3/8" F, lunghezza 30 mm, art. 3841
 - 1/2" M - 1/2" F, lunghezza 37 mm, art. 4841



ADATTATORI DOPPIO QUADRO MASCHIO

FEFMEC articolo	L mm	Euro
2841	20	4,00
3841	30	5,00
4841	37	6,00
BGS 9623 NEW	53	9,69

CARATTERISTICHE

- con doppia sfera



SNODO

attacco: 1/2"

BGS articolo	L mm	Euro
BGS 251	75	10,48



1/4"-3/8"-1/2"

1/4"-3/8"-1/2"



BGS articolo	DESCRIZIONE	Euro
BGS 252	SET 3 PEZZI SNODO CON MOLLA	26,01

CARATTERISTICHE

- cromati



PROLUNGHE

attacco: 1/2"

FEFMEC articolo	L mm	Euro
485-0050	50	5,25
BGS 236	75	6,30
BGS 3120	125	8,93
BGS 3121	250	12,60
BGS 3134	610	36,98



BGS articolo	DESCRIZIONE	Euro
BGS 2237	SET 3 PEZZI, PROLUNGHE	38,25

CARATTERISTICHE

- lunghezze: 450-600-750 mm
- acciaio al carbonio
- finitura lucida



PROLUNGHE CON TESTA SFERICA

attacco: 1/2"

FEFMEC articolo	L mm	Euro
BGS 233	50	6,30
4852-0075	75	6,83
BGS 234	125	9,45
BGS 235	250	15,75
BGS 248	375	24,48
BGS 249	500	31,50

CARATTERISTICHE



BGS articolo	DESCRIZIONE	Euro
BGS 2240	SET 3 PEZZI PROLUNGHE	25,37

CARATTERISTICHE

- lunghezze: 50-125-250 mm
- **testa sferica**
- finitura cromata satinata
- zigrinate





NEW



1/2"



BGS articolo	DESCRIZIONE	Euro
BGS 6112	SET 5 PEZZI, PROLUNGHE TESTA SFERICA, ATT. 1/2"	41,08

CARATTERISTICHE

- comprende le seguenti misure:
 - att. 1/2", lunghezza: 50, 75, 125, 250, 450 mm
- finitura cromata lucida
- in supporto in plastica



NEW



1/4"-3/8"-1/2"



BGS articolo	DESCRIZIONE	Euro
BGS 6113	SET 9 PEZZI, PROLUNGHE TESTA SFERICA	40,04

CARATTERISTICHE

- comprende le seguenti misure:
 - att. 1/4", lunghezza: 50, 100, 225 mm;
 - att. 3/8", lunghezza: 75, 150, 225 mm;
 - att. 1/2", lunghezza: 50, 125, 250 mm.
- finitura cromata lucida
- in supporto in plastica



1/4"-3/8"-1/2"

PRO+

BGS articolo	DESCRIZIONE	Euro
BGS 2253	SET 9 PEZZI, PROLUNGHE TESTA SFERICA	55,97

CARATTERISTICHE

- comprende le seguenti misure:
 - att. 1/4", lunghezza: 50 mm, 100 mm, 250 mm;
 - att. 3/8", lunghezza: 75 mm, 150 mm, 250 mm;
 - att. 1/2", lunghezza: 50 mm, 125 mm, 250 mm.

RICAMBI

BGS articolo		L mm	Euro
BGS 2232	1/4"	50	3,57
BGS 2231	1/4"	100	3,83
BGS 2219	1/4"	250	6,63
BGS 242	3/8"	75	4,08
BGS 243	3/8"	150	5,87
BGS 244	3/8"	250	8,16
BGS 233	1/2"	50	6,30
BGS 234	1/2"	125	9,45
BGS 235	1/2"	250	15,75

FLEX



1/2"

PRO



CV

1/2"

BGS articolo	DESCRIZIONE	Euro
BGS 2323	PROLUNGA FLESSIBILE	28,05

CARATTERISTICHE

- lunghezza: 190 mm
- flessibile fino a 90°
- cromata

FLEX



1/2"

PRO+



1/2"

BGS articolo	DESCRIZIONE	Euro
BGS 8483	PROLUNGA FLESSIBILE, 300 MM, ATT. 1/2"	18,36

CARATTERISTICHE

- lunghezza: 300 mm
- permette l'avvitamento anche in aree difficili da raggiungere
- **ATTENZIONE: da non utilizzare per viti bloccate**



1/4"-3/8"-1/2"



1/4"-3/8"-1/2"

PRO+

CV



BGS articolo	DESCRIZIONE	Euro
BGS 198	SET 3 PEZZI PROLUNGHE MAGNETICHE	17,72

CARATTERISTICHE

- per trattenere viti e bulloni nella bussola



1/2"

PRO+



1/2"

BGS articolo	DESCRIZIONE	Euro
BGS 3125	PROLUNGA CON ILLUMINAZIONE A LED INTEGRATA	23,75

CARATTERISTICHE

- lunghezza: 63 mm
- illumina l'area di lavoro attraverso la bussola
- batterie incluse

1/2" PRO+ CV

BGS articolo	DESCRIZIONE	Euro
BGS 289	ADATTATORE SCORREVOLE PER BARRE ATT. 1/2"	4,59

CARATTERISTICHE

- cromata, satinata
- per impiego con prolunghe

1/2"

QUADRO MASCHIO SCORREVOLE
attacco: 1/2"

BGS articolo	L mm	1	Euro
BGS 273	250	1	11,48
487	300	1	12,68

1/2"

LEVA CON QUADRO SCORREVOLE "POWER IMPACT" BRUNITA
Attacco: 1/2"

BGS articolo	1/2"	L mm	1	Euro
752050	1/2"	300	1	15,75

1/2"

QUADRO MASCHIO AD ANGOLO "POWER IMPACT" BRUNITO
Attacco: 1/2"

BGS articolo	1/2"	L mm	1	Euro
762051	1/2"	250	1	11,55

1/2" ESAGONO PRO+

BGS articolo	DESCRIZIONE	Euro
BGS 1459	CHIAVE A CROCE PER RUOTE DI AUTOMOBILI	15,17

CARATTERISTICHE

- esagono 17, 19, 21 mm, quadro maschio da 1/2"
- finitura cromata, temperata
- lunghezza braccio 150 mm
- conforme DIN 899

1/2" ESAGONO PRO+

BGS articolo	DESCRIZIONE	Euro
BGS 1456	CHIAVE A CROCE PER RUOTE DI AUTOMOBILI, RIPIEGABILE, GIUNTO ARTICOLATO	56,61

CARATTERISTICHE

- esagono 17, 19, 21 mm + quadro maschio 1/2"
- lunghezza 400 mm
- maggiore coppia grazie al giunto regolabile

1/2" ESAGONO

BGS articolo	DESCRIZIONE	Euro
BGS 1510	CHIAVE PER DADI RUOTA ESTENSIBILE, ATTACCO 1/2", 17-19 MM	14,82

CARATTERISTICHE

- bussola intercambiabile con attacco quadro femmina da 1/2", un lato 17 mm esagonale, l'altro lato esagonale 19 mm
- impugnatura rivestita in gomma
- barra estensibile in lunghezza fino a 520 mm

1/2" PRO+ CV

BGS articolo	1/2"	L mm	Euro
BGS 265	1/2"	250	18,62
BGS 267	1/2"	610	40,00

CARATTERISTICHE

- cromata
- attacco quadro nero
- coppia massima 500 Nm

RICAMBI

BGS articolo	DESCRIZIONE	Euro
BGS 265-REPAIR	KIT DI RIPARAZIONE PER ART. BGS 265	5,87
BGS 267-REPAIR	KIT DI RIPARAZIONE PER ART. BGS 267	11,99

1/2" PRO+ CV CROMO

BGS articolo	DESCRIZIONE	Euro
BGS 258	IMPUGNATURA SNODATA ESTENSIBILE	56,48

CARATTERISTICHE

- lunghezza: da 450 a 600 mm
- finitura satinata cromata
- testa con finitura nera
- coppia massima 550 Nm

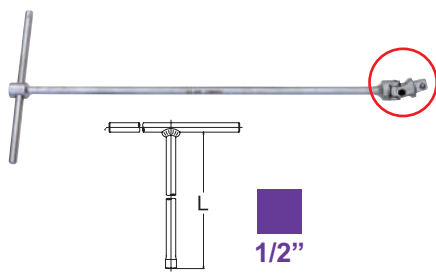
**CHIAVE A "T" QUADRO MASCHIO SNODATA
 CROMATE ASTA SCORREVOLE
 CHROM-VANADIUM**

FEEMEC articolo	1/2"	L mm		Euro
581-1/2"	1/2"	500	1	21,00



1/2"	PRO+		DESCRIZIONE	Euro
BGS			IMPUGNATURA A T, CON QUADRO MASCHIO DA 1/2", LUNGHEZZA 230 MM	16,07

CARATTERISTICHE

- impugnatura ergonomica
- finitura satinata



1/2"	PRO+		DESCRIZIONE	Euro
BGS			IMPUGNATURA A T, CON QUADRO MASCHIO DA 1/2", LUNGHEZZA 230 MM, TESTA SFERICA	17,21

CARATTERISTICHE

- impugnatura ergonomica
- finitura satinata



1/2"	PRO+	DESCRIZIONE	Euro
BGS		CHIAVE A BATTERE PER DADI E PULGEGE	101,75

CARATTERISTICHE

- 620 mm
- idoneo per diverse applicazioni, ad esempio allentamento della vite di tenuta puleggia cinghia, contralbero
- offre un'elevata coppia di allentamento in condizioni di spazio limitato
- speciale impugnatura di sicurezza antiscivolo

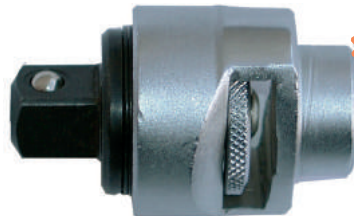

1/2"	PRO	1/2"	DESCRIZIONE	Euro
BGS			ADATTATORE CHIAVE A CRICCHETTO DA 1/2"	38,76

CARATTERISTICHE

- reversibile
- di semplice utilizzo in combinazione con impugnatura BGS 265 o barra scorrevole a T da 1/2"
- lunghezza: 60 mm
- Ø max: 40 mm



1/2"	PRO+		DESCRIZIONE	Euro
BGS			IMPUGNATURA SNODATA CON TESTA A CRICCHETTO	76,37

CARATTERISTICHE

- lunghezza 620 mm
- coppia massima 512 Nm

RICAMBI

BGS	DESCRIZIONE	Euro
BGS 228-1	KIT DI RIPARAZIONE	34,43

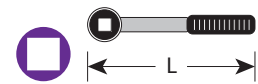
CRICCHETTO REVERSIBILE CON QUADRO FEMMINA PASSANTE

FEEMEC articolo	1/2"	L mm	Euro
BGS 9160	NEW 1/4"	115	23,14
3940	3/8"	260	28,00
BGS 312	1/2"	270	38,00
5840	3/4"	450	60,00
BGS 9622	NEW 3/4"	500	123,68
6040	10 mm	250	30,00
6340	13 mm	250	38,00
6540	15 mm	250	38,00
6640	16 mm	250	38,00

CARATTERISTICHE

- quadro passante
- impugnatura rivestita



1/2"	DESCRIZIONE	Euro
BGS	CRICCHETTO REVERSIBILE CON QUADRO MASCHIO INTERCAMBIABILE - ESTRAIBILE	42,00

attacco: 1/2"

FEEMEC articolo	L mm		Euro
484	280	1	42,00



1/2"	PRO+		DESCRIZIONE	Euro
BGS			CHIAVE A CRICCHETTO PASSANTE CON CHIAVI SPECIALI	53,42

CARATTERISTICHE

- chiave di montaggio da 3/8" - 7/16" - 1/2" - 5/8" - 13/16"
- attacco quadro da 1/2"
- finitura cromata satinata

MECCANISMO 36 DENTI



1/2"

CRICCHETTO REVERSIBILE 36 DENTI CON PULSANTE DI BLOCCAGGIO BUSSOLA
attacco: 1/2"

FERMEC	L		Euro
articolo	mm		
483	280	1	43,05

MECCANISMO 72 DENTI



1/2"



NUOVI CRICCHETTI REVERSIBILI A 72 DENTI CON PULSANTE DI SBLOCCAGGIO DELLA BUSSOLA ED IMPUGNATURA ERGONOMICA BI-COMPONENTE ANTISCIVOLO E FORMA OVALE

FERMEC	L		Euro
articolo	mm		
872	250	1	36,75

576787	SET 3 PEZZI 1/4" - 3/8" - 1/2"	1	94,50
--------	-----------------------------------	---	-------

MECCANISMO 72 DENTI



1/4"-3/8"-1/2" **PRO+** **CV**

BGS	DESCRIZIONE	Euro
articolo		
BGS 215	SET 3 PEZZI, CRICCHETTI REVERSIBILI COMPATTI	95,63

CARATTERISTICHE

- formato extra-small per spazi ridotti e angusti
- 72 denti
- lunghezza cricchetti:
 - attacco 1/4": 110 mm
 - attacco 3/8": 140 mm
 - attacco 1/2": 170 mm

MECCANISMO 72 DENTI



1/2" **CV**

BGS	DESCRIZIONE	Euro
articolo		
BGS 519	CRICCHETTO REVERSIBILE, 72 DENTI, ATTACCO 1/2"	26,26

CARATTERISTICHE

- impugnatura in materiale bi-componente
- con sgancio rapido
- lunghezza 255 mm

MECCANISMO 72 DENTI



1/2" **PRO+** **CV**

BGS	DESCRIZIONE	Euro
articolo		
BGS 320	CRICCHETTO REVERSIBILE 1/2"	41,82

CARATTERISTICHE

- con pulsante di sgancio rapido
- stelo sfasato
- impugnatura ergonomica antiscivolo in materiale bi-componente
- lunghezza 255 mm

NEW



1/2" **CV** **PRO+**

BGS	DESCRIZIONE	Euro
articolo		
BGS 612	CRICCHETTO REVERSIBILE, "EXTRA SLIM", ATTACCO 1/2"	49,73

CARATTERISTICHE

- cricchetto reversibile 72 denti
- modello dritto "extra slim"
- con pulsante di sgancio rapido
- acciaio al Cromo Vanadio
- lunghezza: 250 mm
- peso: 420 grammi
- impugnatura in materiale bi-componente

NEW



1/2" **CV** **PRO+**

BGS 602-REPAIR



BGS	DESCRIZIONE	Euro
articolo		
BGS 602	CRICCHETTO REVERSIBILE, MODELLO CURVO, ATTACCO 1/2"	26,78

CARATTERISTICHE

- cricchetto reversibile 90 denti
- modello curvo
- con pulsante di sgancio rapido
- acciaio al Cromo Vanadio
- lunghezza: 255 mm
- peso: 550 grammi
- impugnatura in materiale bi-componente

RICAMBI

BGS	DESCRIZIONE	Euro
articolo		
BGS 602-REPAIR	SET RIPARAZIONE CRICCHETTO	10,07

XXL

MECCANISMO 72 DENTI



1/2" **PRO+** **CV**

BGS	DESCRIZIONE	Euro
articolo		
BGS 324	CRICCHETTO REVERSIBILE EXTRA LUNGO	56,25

CARATTERISTICHE

- 72 denti
- lunghezza 380 mm
- impugnatura ergonomica antiscivolo in materiale bi-componente

1/2"



1/2"

PRO+

CV

BGS articolo	DESCRIZIONE	Euro
BGS 2206	CHIAVE A CRICCHETTO REVERSIBILE 1/2"	36,98

CARATTERISTICHE

- impugnatura in ABS
- con pulsante di sgancio rapido
- lunghezza 260 mm



1/2"

PRO+

CV

BGS articolo	DESCRIZIONE	Euro
BGS 2304	CRICCHETTO REVERSIBILE 1/2"	33,92

CARATTERISTICHE

- con pulsante di sgancio rapido
- impugnatura in gomma in materiale bi-componente
- lunghezza 210 mm



1/2"

PRO+

CV

BGS articolo	DESCRIZIONE	Euro
BGS 317	CRICCHETTO REVERSIBILE 1/2"	39,53

CARATTERISTICHE

- con pulsante di sgancio rapido
- impugnatura ergonomica antiscivolo in materiale bi-componente
- lunghezza 255 mm



1/2"

PRO+

CV

BGS articolo	DESCRIZIONE	Euro
BGS 210	CRICCHETTO "COMPATTO" 1/2"	36,98

CARATTERISTICHE

- extra-piccolo
- lunghezza 170 mm
- 72 denti
- con pulsante di sgancio rapido



1/2"

PRO+

CV

BGS articolo	DESCRIZIONE	Euro
BGS 304	CHIAVE A CRICCHETTO IN NYLON E FIBRA DI VETRO 1/2"	33,66

CARATTERISTICHE

- con pulsante di sgancio rapido
- comodo utilizzo grazie ai materiali ultra-leggeri, nessun affaticamento
- i test su questo attrezzo hanno ottenuto risultati per capacità massima decisamente superiori ai limiti DIN
- lunghezza: circa 255 mm
- in polipropilene rivestito in acciaio CR-V con impugnatura in materiale bi-componente



1/2"



CV

BGS articolo	DESCRIZIONE	Euro
BGS 2300	CRICCHETTO "KRAFTMANN" 1/2"	15,34

CARATTERISTICHE

- reversibile
- con impugnatura ergonomica in gomma
- lunghezza 240 mm



1/2"

PRO+

CV

BGS articolo	DESCRIZIONE	Euro
BGS 25108	CRICCHETTO REVERSIBILE ESTENSIBILE, 450-610 MM, ATTACCO 1/2"	62,73

CARATTERISTICHE

- regolabile in 6 posizioni da 450 a 610 mm
- cricchetto 72 denti
- con pulsante di sgancio rapido

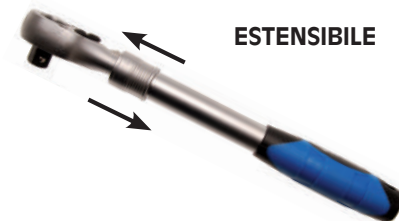

ESTENSIBILE

1/2"

PRO+

BGS articolo	DESCRIZIONE	Euro
BGS 25104	CRICCHETTO REVERSIBILE ESTENSIBILE, 305-445 MM, ATTACCO 1/2"	50,87

CARATTERISTICHE

- regolabile in 5 posizioni da 305 a 445 mm
- acciaio al cromo vanadio, satinato
- cricchetto 72 denti
- con pulsante di sgancio rapido



MECCANISMO 48 DENTI

BGS 2315-REPAIR

 articolo **1/2" PRO+**

BGS articolo	DESCRIZIONE	Euro
BGS 2315	CHIAVE A CRICCHETTO ESTENSIBILE	105,83

CARATTERISTICHE

- la testa può essere utilizzata con 3 impugnature di diversa lunghezza; ne consegue una cricchetto di lunghezza totale potenziale di: 220 mm, 360 mm, 565 mm
- coppia massima 575 Nm

RICAMBI

BGS articolo	DESCRIZIONE	Euro
BGS 2315-REPAIR	KIT DI RIPARAZIONE	19,13



1/2" PRO+ CV

BGS articolo	DESCRIZIONE	Euro
BGS 2272	CHIAVE A CRICCHETTO A RUOTA LIBERA (SENZA DENTI) 1/2"	59,93

CARATTERISTICHE

- con quadro maschio scorrevole
- elimina l'angolo di ripresa dei cricchetti tradizionali
- ideale per l'utilizzo in spazi ridotti
- lunghezza 245 mm



TESTA SNODATA

MECCANISMO 72 DENTI

1/2" PRO+

BGS articolo	DESCRIZIONE	Euro
BGS 114	CHIAVE A CRICCHETTO CON TESTA SNODATA, REGOLABILE, 1/2"	55,97

CARATTERISTICHE

- testa snodata 180°
- finitura cromata
- cricchetto reversibile 72 denti
- con pulsante di sgancio rapido
- lunghezza 310 mm



TESTA SNODATA 90°

MECCANISMO 45 DENTI

1/2" PRO+ CV

BGS articolo	DESCRIZIONE	Euro
BGS 287	CHIAVE A CRICCHETTO CON TESTA SNODATA, REGOLABILE 1/2"	58,75

CARATTERISTICHE

- finitura satinata cromata
- regolabili in sicurezza in 5 posizioni
- 45 denti
- con pulsante di sgancio rapido
- impugnatura con occhiello
- lunghezza 290 mm



TESTA SNODATA + ESTENSIBILE

MECCANISMO 72 DENTI

1/2" PRO+ CV

BGS articolo	DESCRIZIONE	Euro
BGS 25107	CRICCHETTO REVERSIBILE ESTENSIBILE SNODATO, 345-495 MM, ATTACCO 1/2"	66,30

CARATTERISTICHE

- regolabile in 6 posizioni da 345 a 495 mm
- testa snodata 180°, regolabile in 10 posizioni
- cricchetto 72 denti
- con pulsante di sgancio rapido
- acciaio al cromo vanadio
- lunghezza 290 mm

QUANDO MANCA LO SPAZIO



RUOTANDO L'IMPUGNATURA SI OTTIENE LA ROTAZIONE DEL QUADRO DX/SX

1/2"

CRICCHETTO DOPPIA FUNZIONE:

- AZIONE A "CRICCO TRADIZIONALE"
- IMPUGNATURA ROTATIVA
- QUADRO MASCHIO SCORREVOLE

BGS articolo	L mm		Euro	
972	1/2"	280	1	48,50



1/2"

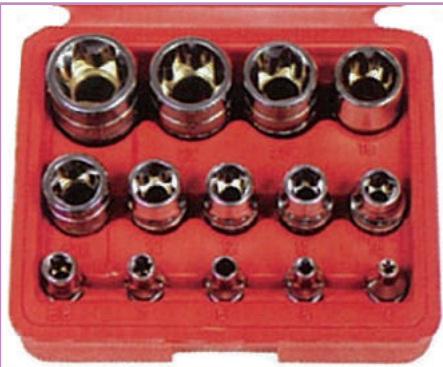

1/4"-3/8"-1/2"



TORX®

- 5 BUSSOLE TORX® FEMMINA ATT. 1/4" E 4-5-6-7-8
- 5 BUSSOLE TORX® FEMMINA ATT. 3/8" E 10-11-12-14-16
- 4 BUSSOLE TORX® FEMMINA ATT. 1/2" E 18-20-22-24

attacco: 1/4" - 3/8" - 1/2"
impronta: TORX®

FEFMEC articolo	Descrizione	Impronta	Euro
54214	CASSETTA PLASTICA 14 PEZZI	1	44,10



1/2"



TORX® TORX®

- 9 BUSSOLE TORX® FEMMINA
- E 10-11-12-14-16-18-20-22-24
- 10 BUSSOLE CON INSERTI TORX®
- T 20-25-27-30-40-45-50-55-60-70

attacco: 1/2"
impronta: TORX®

FEFMEC articolo	Descrizione	Impronta	Euro
54019	CASSETTA PLASTICA 19 PEZZI	1	57,75



TORX®



TORX® TORX® CON FORO 1/4"-1/2"

FEFMEC articolo	DESCRIZIONE	Euro
2271	SET 72 PEZZI, UTENSILI TORX ATT. 1/4" + 1/2"	115,00

CARATTERISTICHE

- bussole torx femmina:
 - att. 1/4": E4 - E5 - E6 - E7 - E8 - E10 - E11
 - att. 1/2": E12 - E14 - E16 - E18 - E20 - E22 - E24
- chiavi a bussola Torx, att. 1/4": TX10 - TX15 - TX20 - TX25 - TX27 - TX30
- inserti att. 10 mm, lunghezza 30 mm, Torx c/ foro: TH40 - TH45 - TH50 - TH55 - TH60 - TH70
- inserti att. 10 mm, lunghezza 75 mm, Torx: TX15 - TX20 - TX25 - TX30 - TX40 - TX45 - TX50 - TX55 - TX60
- inserti att. 1/4", lunghezza 25 mm:
 - Torx: TX7 - TX8 - TX9
 - Torx con foro: TH10 - TH15 - TH20 - TH25 - TH27 - TH30 - TH40
- Chiave Torx tipo L: TX8 - TX10 - TX15 - TX20 - TX25 - TX27 - TX30 - TX40 - TX45 - TX50 - TX55 - TX60
- cacciaviti Torx: TX8 - TX10 - TX15 - TX20 - TX25 - TX27 - TX30 - TX40
- chiavi doppio anello: E6 x E8 - E10 x E12 - E14 x E18 - E20 x E24
- adattatori
 - portainseri esag. fem. 1/4" - quadro fem. 1/4"
 - portainseri esag. fem. 10 mm - quadro fem. 1/2"
- utensile di raccolta magnetico



1/2"



CV

PRO+

BGS articolo	DESCRIZIONE	Euro
BGS 6425	SET 9 PEZZI, BUSSOLE TIPO TORX	31,62

CARATTERISTICHE

- E10-11-12-14-16-18-20-22-24
- finitura satinata cromata



TORX®

TORX® CON FORO



1/2"

PRO+

CV

BGS articolo	DESCRIZIONE	Euro
BGS 5101	SET 27 PEZZI INSERTI E CHIAVI A BUSSOLA TORX	55,46

CARATTERISTICHE

- conformi DIN
- 5 chiavi a bussola attacco da 1/2" T45-50-55-60-70
- 7 inserti per viti Torx Tx10-15-20-25-27-30-40
- 12 inserti Torx c/foro: Th10-15-20-25-27-30-40-45-50-55-60-70
- 3 adattatori per inserti attacco da 1/4" - 3/8" - 1/2"

TORX®	S mm	S mm	S mm
E 4	3.70	E 16	14.60
E 5	4.60	E 18	16.50
E 6	5.60	E 20	18.30
E 7	6.10	E 22	20.10
E 8	7.40	E 24	22.00
E 10	9.30	E 26	23.70
E 11	9.90	E 28	25.50
E 12	11.00	E 30	27.30
E 14	12.80	E 32	29.00





TORX® TORX® CON FORO 1/4"-1/2"

PRO+ CV

BGS articolo	DESCRIZIONE	Euro
BGS 7849	SET 84 PEZZI, UTENSILI TORX ATT. 1/4" + 1/2"	206,25

CARATTERISTICHE

- utensili attacco 1/2":
- bussole: E12 - E14 - E16 - E18 - E20 - E22 - E24
- adattatore portainserti attacco 10 mm
- adattatore portainserti attacco 14 mm
- utensili att. 1/4":
- bussole: E4 - E5 - E6 - E7 - E8 - E10 - E11
- chiavi a bussola att. 1/4", lunghezza 37 mm
Torx: TX10 - TX15 - TX20 - TX25 - TX27 - TX30
- adatt. portainserti att. 1/4"
- inserti attacco 10 mm, lunghezza 30 mm, Torx con foro: TH40 - TH45 - TH50 - TH55 - TH60 - TH70
- inserti att. 10 mm, lunghezza 75 mm, Torx: TX15 - TX20 - TX25 - TX30 - TX40 - TX45 - TX50
- inserti attacco 14 mm:
- lunghezza 40 mm, Torx c/foro: TX80-TX90-TX100
- lunghezza 75 mm, Torx: TX55 - TX60
- inserti attacco 1/4" esagonale:
- lunghezza 25 mm, 5 punte con foro: TS7-TS8-TS9
- lunghezza 25 mm, Torx con foro: TH10-TH15-TH20-TH25 - TH27 - TH30 - TH40
- Torx con foro: TX10 - TX15-TX20-TX25-TX27-TX30-TH40 - TX45
- Chiave Torx tipo L: TX8- TX10- TX15- TX20- TX25- TX27- TX30- TX40- TX45- TX50- TX55- TX60
- chiavi doppio anello: E6 x E8, E10 x E12, E14 x E18, E20 x E24
- cacciavite Torx con foro: TH8 - TH10 - TH15 - TH20 - TH25 - TH27 - TH30 - TH40
- asta magnetica telescopica

PROMO



1/2" CV PRO+ ESAGONO

BGS articolo	DESCRIZIONE	Euro
BGS 2224	SET 27 PEZZI, BUSSOLE ATT. 1/2", 8-32 MM	131,25

CARATTERISTICHE

- conformi DIN
- bussole esagonali
- cricchetto reversibile da 72 denti
- 2 prolunghe testa sferica: 125 + 250 mm
- 1 quadro scorrevole per prolunghe
- 1 snodo
- 2 bussole per candele: 16 + 21 mm
- 20 bussole esagonali: 8-9-10-11-12-13-14-15-16-17-18-19-20-21-22-23-24-27-30-32 mm

RICAMBI

BGS articolo	DESCRIZIONE	Euro
BGS 2224-LEER	CASSETTA VUOTA	19,13

POLLICI



1/2" CV PRO+ ESAGONO

BGS articolo	DESCRIZIONE	Euro
BGS 2216	SET 27 PEZZI, BUSSOLE ATT. 1/2", IN POLLICI	131,25

CARATTERISTICHE

- conformi DIN
- bussole esagonali
- cricchetto reversibile da 72 denti
- 2 prolunghe testa sferica: 125 + 250 mm
- 1 quadro scorrevole per prolunghe
- 2 bussole per candele: 5/8" + 13/16"
- 20 bussole esagonali: 5/16" - 11/32" - 3/8" - 7/16" - 15/32" - 1/2" - 9/16" - 19/32" - 5/8" - 21/32" - 11/16" - 3/4" - 25/32" - 13/16" - 7/8" - 15/16" - 1" - 1 1/16" - 1 3/16" - 1 1/4"



1/2"

ESAGONO

CV

BGS articolo	DESCRIZIONE	Euro
BGS 15110	SET 19 PEZZI, CRICCHETTO E BUSSOLE, ATTACCO 1/2"	71,50

CARATTERISTICHE

- cricchetto reversibile attacco 1/2"
- 18 bussole esagonali attacco quadro 1/2":
8 - 9 - 10 - 11 - 12 - 13 - 14 - 15 - 16 - 17 - 19 - 21 - 22 23 - 24 - 27 - 30 - 32 mm
- con supporto in plastica

SET 1/2"

**BUSSOLE
MULTIMPRONTA
SPLINE DRIVE**

1/2"

**BUSSOLE
MULTIMPRONTA**
**MULTIMPRONTA
SPLINE DRIVE**

**CASSETTA BUSSOLE MULTIMPRONTA
ATTACCO 1/2" ADATTE PER DADI
ESAGONALI POLIGONALI - POLLICI
QUADRI - XZN® - TORX®
PEZZI 42 DA 10-32 MM
+ INSERTI XZN, ESAGONO E TORX**

articolo

Descrizione



Euro

FRM 4422

VALIGETTA 42 PEZZI

1

130,00

PROMO
NEW

**BUSSOLE
ESAGONALI**

articolo

DESCRIZIONE

Euro

BGS 9366

**SET 44 PEZZI,
BUSSOLE PASSANTI**

211,25

CARATTERISTICHE

- ideale per avvitare dadi con fuoriuscita del filetto
- materiale:
 - bussole in acciaio Chrome-Vanadium
 - inserti in acciaio Chrome-Vanadium S2
- comprende:
 - cricchetto passante, 72 denti, misura interna 12 mm
 - bussole esagonali passanti, attacco speciale 12 mm: 6-7-8-9-10-11-12-13-14 mm
 - adattatore attacco speciale 12 mm-quadro maschio 3/8"
 - 33 inserti in acciaio S2, attacco speciale 12 mm
 - XZN: M4 - M5 - M6 - M8 - M10 - M12
 - RIBE: M5 - M6 - M7 - M8 - M10 - M12 - M13
 - Torx: TX15-TX20-TX25-TX27-TX30-TX40-TX45
 - Torx c/Foro: TH15-TH20-TH25-TH27-TH30-TH40-TH45
 - Esagonali: 4 - 5 - 6 - 7 - 8 - 10 mm

PROMO
NEW

BGS 2181-1

BGS 2181-2

BGS 2181-3

**BUSSOLE
MULTIMPRONTA**

articolo

DESCRIZIONE

Euro

BGS 2181

SET 52 PEZZI, BUSSOLE PASSANTI MULTIMPRONTA, 4,5 - 25 MM

241,25

CARATTERISTICHE

- particolarmente adatto per avvitare dadi con fuoriuscita del filetto
- non limitata la profondità come nelle normali bussole
- utensili con attacco esagonale da 13 mm:
 - cricchetto passante, 72 denti, esagono femmina da 13 mm
 - prolunga, 75 mm, con foro passante
 - 11 bussole multimpronta, lunghezza 25 mm: 4,5-5-5,5-6-7-8-9-10-11-12-13 mm
 - adattatore esagono maschio 13 mm - quadro maschio 1/4"
 - adattatore esagono maschio 13 mm - quadro maschio 1/4", per uso con prolunga con foro passante
 - adattatore portainseriti, esagono maschio 13 mm - esagono femmina 1/4", permette l'uso del cricchetto come cricchetto portainseriti 1/4" standard
- utensili con attacco esagonale da 19 mm:
 - cricchetto passante, 72 denti, esagono femmina da 19 mm
 - prolunga, 75 mm, con foro passante
 - 11 bussole multimpronta, lunghezza 30 mm: 8-10-11-12-13-14-15-16-17-18-19 mm
 - adattatore esagono maschio 19 mm - quadro maschio 3/8"
 - adattatore esagono maschio 19 mm - quadro maschio 3/8", per uso con prolunga con foro passante
- utensili con attacco esagonale da 22 mm:
 - cricchetto passante, 72 denti, esagono femmina da 22 mm
 - prolunga, 75 mm, con foro passante
 - 7 bussole multimpronta, lunghezza 40 mm: 19-20-21-22-23-24-25 mm
 - adattatore esagono maschio 22 mm - quadro maschio 1/2"
 - adattatore esagono maschio 22 mm - quadro maschio 1/2", per uso con prolunga con foro passante
- 10 inserti con attacco esagonale 1/4":
 - Taglio: 4 e 5 mm
 - PH1 e PH2
 - Torx: TX10 - TX15 - TX20
 - Esagono: 4 - 5 - 6 mm

RICAMBI

articolo	DESCRIZIONE	Euro
BGS 2181-1	CRICCHETTO PASSANTE 13 MM	23,46
BGS 2181-2	CRICCHETTO PASSANTE 19 MM	28,56
BGS 2181-3	CRICCHETTO PASSANTE 22 MM	38,76



PROMO

NEW



BUSSOLE ESAGONALI



1/4"



BGS articolo	DESCRIZIONE	Euro
BGS 2039	CASSETTA 84 PEZZI CHIAVI A BUSOLA E UTENSILI ASSORTITI	250,90

CARATTERISTICHE

- comprende:
- chiavi combinate, finitura satinata cromata: 8 - 9 - 10 - 11 - 12 - 13 - 14 - 17 - 19 - 21 mm
- utensili con attacco quadro 3/8":
 - cricchetto reversibile, 72 denti
 - snodo
 - prolunga, 150 mm
 - adattatore portainseriti con attacco 1/4"
 - bussole, finitura satinata cromata: 8 - 10 - 11 - 12 - 13 - 14 - 15 - 16 - 17 - 18 - 19 - 21 - 22 mm
 - bussola esagonale per candele 16 mm, con inserto in gomma, lungh. 64 mm
 - bussola esagonale per candele 21 mm, con inserto in gomma, lungh. 64 mm
- inserti attacco esagonale 1/4":
 - taglio: 4,0 - 5,5 - 6,5 mm
 - PH: PH1 - PH1 - PH2 - PH2 - PH3 - PH3
 - PZ: PZ1 - PZ1 - PZ2 - PZ2 - PZ3 - PZ3
 - Torx: TX8 - TX9 - TX10 - TX15 - TX20 - TX25 - TX27 - TX30 - TX40
 - esagonali: 3 - 4 - 5 - 6 - 7 - 8 mm
 - portainseriti
- cacciaviti:
 - taglio: 1,2x8,0x150 - 1,0x5,5x100 mm
 - PH: PH1x100 - PH2x100 - PZ2x100 mm
 - impugnatura portainseriti con attacco esagonale 1/4", lunghezza 75 mm
 - tester (taglio 3x60)
- chiavi combinate, finitura satinata cromata: 8 - 9 - 10 - 11 - 12 - 13 - 14 - 17 - 19 - 21 mm
- chiavi a L esagonali con testa sferica sul lato lungo: 1,5 - 2 - 2,5 - 3 - 4 - 5 - 6 - 8 - 10 mm
- pinza regolabile, 245 mm
- pinze, 180 mm
- tronchese con tagliente laterale, 160 mm
- martello, 300 g
- seghetto, 300 mm, con lama
- flessometro, 5 m
- cutter con lame 18 mm, con 1 lama
- asta telescopica magnetica, magneti 11 mm, lunghezza 132 - 570 mm

PROMO

NEW



BUSSOLE ESAGONALI



1/4"



BGS articolo	DESCRIZIONE	Euro
BGS 2037	CASSETTA 58 PEZZI, CHIAVI A BUSOLA E UTENSILI ASSORTITI	110,50

CARATTERISTICHE

- comprende:
- utensili con attacco quadro 1/4":
 - cricchetto reversibile, 72 denti
 - prolunga, 50 mm
 - adattatore portainseriti con attacco 1/4"
 - bussole, finitura satinata cromata: 4 - 6 - 7 - 8 - 9 - 10 - 11 - 12 - 13 mm
- inserti attacco esagonale 1/4":
 - taglio: 3 - 4 - 5 - 6 mm
 - PH: PH1 - PH2 - PH3
 - PZ: PZ1 - PZ2 - PZ3
 - Torx: T10 - T15 - T20 - T25 - T27 - T30
 - esagonali: 3 - 4 - 5 - 6 mm
- cacciaviti:
 - taglio: 0,4x2,0x50 mm - 0,4x2,5x50 mm - 0,5x3,0x50 mm
 - 1,0x5,5x75 mm - 1,2x6,5x38 mm - 1,2x6,5x100 mm
 - PH: PH00x50 mm - PH0x50 mm - PH1x75 mm
 - PH2x38 mm - PH2x100 mm
 - impugnatura portainseriti con attacco esagonale 1/4", lunghezza 75 mm
- chiavi a L esagonali: 1,5 - 2 - 2,5 - 3 - 4 - 5 - 6 - 8 - 10 mm
- pinza regolabile, 245 mm
- pinze, 180 mm
- pinze a becchi mezzotondi dritti, 200 mm
- martello, 300 g



NEW



assortimento speciale
per CAMIONISTI



BUSSOLE
ESAGONALI



FERMEC	DESCRIZIONE	Euro
articolo	CASSETTA 58 PEZZI, CHIAVI A BUSSOLA E UTENSILI ASSORTITI PER TRUCK	250,00
64230		

CARATTERISTICHE

- assortimento particolarmente indicato per operazioni su veicoli pesanti/trucks
- cassetta in ABS ad alta resistenza con 4 chiusure
- dimensioni cassetta: (lunghezza x larghezza x altezza) 535 x 420 x 100 mm
- comprende:
 - 18 chiavi combinate: 7 - 8 - 10 - 11 - 12 - 13 - 14 - 15 - 16 - 17 - 18 - 19 - 21 - 22 - 24 - 27 - 30 - 32 mm
 - 16 chiavi a bussola esagonali att. 1/2": 10 - 11 - 12 - 13 - 14 - 15 - 16 - 17 - 18 - 19 - 21 - 22 - 24 - 27 - 30 - 32 mm
 - 4 chiavi a L esagonali: 4 - 6 - 8 - 10 mm
 - 4 chiavi a L Torx: TX10 - TX20 - TX25 - TX30
 - 2 prolunghe att. 1/2": 125, 250 mm
 - snodo, att. 1/2"
 - testa scorrevole per prolunghe, att. 1/2"
 - 3 cacciaviti taglio: 5,5 x 125 mm - 6,5 x 150 mm - 6 x 38 mm
 - 3 cacciaviti PH: PH1 X 75 mm - PH2 X 100 mm - PH 2 X 38 mm
 - cricchetto reversibile con sgancio rapido, att. 1/2"
 - cacciavite cercafase 250 V
 - martello 300 gr
 - pinza universale 180 mm
 - pinze giratubi regolabili 250 mm
 - forbici 140 mm



NEW PROMO

BUSSOLE ESAGONALI



PRO+



BGS articolo	DESCRIZIONE	Euro
BGS 9029	CASSETTA 117 PEZZI CHIAVI A BUSSOLA E UTENSILI ASSORTITI	299,90

CARATTERISTICHE

- utensili attacco 1/4":
 - cricchetto con sgancio rapido, 72 denti, lunghezza 145 mm, impugnatura in materiale bi-componente
 - bussole esagonali: 4-5-6-7-8-9-10-11-12-13 mm
 - bussole esagonali lunghe: 9-10-11-12-13 mm
 - impugnatura attacco quadro 150 mm
 - snodo
 - prolunga 50 mm
 - adattatore portainseriti attacco 1/4" esagonale
- utensili attacco 1/2":
 - cricchetto con sgancio rapido, 72 denti, lunghezza 145 mm, impugnatura in materiale bi-componente
 - bussole esagonali: 10-11-12-13-14-15-17-19-22-24-27-30-32 mm
 - prolunga 125 mm
 - snodo
- set 32 inserti att. 1/4" colorati lunghezza 25 mm
 - Taglio 3-4-5-6 mm
 - PH: 1-2-2-3
 - PZ: 1-2-2-3
 - Esagonali: 3-4-5-6 mm
 - Torx: TX10-15-20-25-27-30-40
 - Torx con Foro: TH10-15-20-25-27-30-40
 - adattatore portabussole
 - portainseriti a sgancio rapido
- chiavi combinate finitura satinata cromata: 6 - 7 - 8 - 9 - 10 - 11 - 12 - 13 - 14 - 17 - 19 - 22 mm
- tronchese taglio diagonale, 165 mm, impugnature in materiale bi-componente
- pinza, 175 mm, impugnature in materiale bi-componente
- pinza regolabile, 240 mm, impugnature rivestite, apertura max 38 mm
- pinza per crimpatura 235 mm
 - per morsetti non isolati di formato: 1,5 - 2,5 - 4,6 mm
 - per morsetti isolati di formato: 1,5 mm (rosso) - 2,5 mm (blu) - 6 mm (giallo)
 - spellafili: 0,75 - 1,0 - 1,5 - 2,5 - 4,0 - 6,0 mm
 - tagliabulloni per teste bulloni: M2,6 - M3 - M3,5 - M4 - M5
- assortimento terminali isolati
- cacciaviti Taglio: 6x38, 6x100, 8x150 mm
- cacciaviti: PH2x38, PH2x100 mm
- martello tipo tedesco, impugnatura in hickory, 300 g
- torcia a led estensibile con magnete
 - asta telescopica estensibile da 170 a 545 mm con testa magnetica flessibile per sollevare oggetti in metallo
 - 3 led ad alta luminosità e lunga durata
 - corpo in alluminio con clip
 - capacità magnete: 1 kg
 - diametro: 25 mm
 - alimentazione 4 batterie LR44, incluse



NEW

BUSSOLE ESAGONALI



BGS articolo	DESCRIZIONE	Euro
BGS 2204	CASSETTA IN ALLUMINIO CON 129 UTENSILI	250,00

CARATTERISTICHE

- comprende:
 - cutter con lama 18 mm + 10 lame di ricambio
 - chiave regolabile a rullino, 200 mm
 - pinza regolabile, 250 mm
 - pinza, 175 mm
 - pinza becchi mezzotondi lunghi, 200 mm
 - livella, 230 mm
 - flessometro, 15 mm x 3 m
 - chiave a cricchetto reversibile, att. quadro 1/4", 72 denti
 - prolunga, att. quadro 1/4", 100 mm
 - impugnatura, att. quadro 1/4", 150 mm
 - set 13 bussole su guida, att. quadro 1/4":
 - 4 - 4,5 - 5 - 5,5 - 6 - 7 - 8 - 9 - 10 - 11 - 12 - 13 - 14 mm
 - adattatore portainseriti: quadro 1/4" - esagono 1/4"
 - inserti attacco esagonale 1/4":
 - 19 pezzi, taglio 3 - 8 mm
 - 11 pezzi, esagonale 2 - 8 mm
 - 8 pezzi, PZ0 - PZ3
 - 8 pezzi, PH0 - PH3
 - 10 pezzi, Torx, TX8 - TX40
 - 4 pezzi, quadro 2 - 3,5 mm
 - 1 portainseriti
 - tester a cacciavite, 100 - 250 volt
 - mini cacciavite:
 - taglio: 2,5x50 mm
 - PH: PH00x50 mm
 - cacciaviti a taglio: 5,5x75 mm, 6,5x100 mm, 8x125 mm
 - cacciaviti PH: PH1x75 mm, PH2x100 mm
 - impugnatura portainseriti, att. esagonale 1/4"
 - seghetto 260 mm + 7 lame
 - set 9 chiavi a "L" esagonali con testa sferica: 1,5 - 2 - 2,5 - 3 - 4 - 5 - 6 - 8 - 10 mm
 - chiavi a forchetta doppie, cromate satinata:
 - 6x7 - 8x9 - 10x11 - 12x13 - 14x15 - 16x17 - 18x19 - 20x22 mm
 - martello, 300 g
- cassetta in alluminio dimensioni: 425 x 350 x 235 mm

RICAMBI

BGS articolo	DESCRIZIONE	Euro
BGS 2204-LEER	CASSETTA VUOTA	88,40

SET 1/2"



**LA PIU' IMITATA
LA PIU' VENDUTA**

PROMO



**BUSSOLE
ESAGONALI**



**1/4"
1/2"**

articolo	DESCRIZIONE	Euro
24128	VALIGETTA CON UTENSILI PROFESSIONALI + BUSSOLE DA 1/4" + 1/2" IDEALE PER ASSISTENZA E MANUTENZIONE	320,00

CARATTERISTICHE

- Valigetta in alluminio - 460x330x150 mm
- 13 Bussole da 1/2": 12, 13, 14, 15, 16, 17, 18, 19, 21, 24, 27, 30, 32 mm
- 1 Cricchetto da 1/2"
- 2 Prolunghe da 1/2": 125, 250 mm
- 1 Leva con quadro scorrevole da 1/2"
- 2 Snodi - 1/2", 1/4"
- 13 Bussole da 1/4": 4, 4,5, 5, 5,5, 6, 7, 8, 9, 10, 11, 12, 13, 14 mm
- 1 Cricchetto da 1/4"
- 2 Prolunghe da 1/4" (50, 100 mm)
- 1 Leva con quadro scorrevole da 1/4"
- 1 Calibro
- 1 Martello
- 1 Flessometro
- 9 Chiavi combinate - 8, 10, 11, 12, 13, 15, 17, 19, 21 mm
- 9 Brugole a L con testa sferica: 1,5, 2, 2,5, 3, 4, 5, 6, 8, 10 mm
- 1 Chiave inglese
- 2 Pinze + 1 Giratubi + 2 Tronchesi
- 1 Forbici
- 4 Cacciaviti - Taglio 5 e 6, PH 1 e 2
- 1 Pinza per Seeger + 2 Ricambi
- 1 Livella
- 1 Cutter
- 1 Seghetto + 3 Lame per seghetto
- 1 Cricchetto per inserti
- 30 Inserti:
Taglio: 3, 4, 5, 5, 7 mm
Esagonali: 3, 4, 5, 6 mm
PH: 1, 2, 3, 4
PZ: 1, 2, 3, 4
Torx: T10, 15, 20, 25, 30, 35, 40
Torx con foro: T10, 15, 20, 25, 30, 35, 40
- 1 Box per inserti
- 1 Adattatore per bussole da 1/4"
- 1 Porta inserti a sgancio rapido

RICAMBI

articolo	DESCRIZIONE	Euro
24128-V	VALIGETTA VUOTA IN ALLUMINIO PER 24128	60,90

**VALIGETTA
IN ALLUMINIO
RINFORZATA**

PROMO

**BUSSOLE
SURFACE DRIVE**



CV

PRO+

articolo	DESCRIZIONE	Euro
BGS 15501	VALIGETTA PROFESSIONALE IN ALLUMINIO CON 149 UTENSILI	560,00

CARATTERISTICHE

- cricchetti reversibili: 1/4 " + 1/2"
- bussole att. 1/4 ", surface drive: 4-4,5-5-5,5-6-7-8-9-10-11-12-13-14 mm
- bussole att. 1/2 ", surface drive: 10-13-14-16-17-18-19-20-22-24-27-30-32 mm
- impugnatura portabussole, att. Quadro maschio 1/4 "
- snodi: 1/4 " + 1/2"
- prolunghe att. 1/4 ": 50 + 100 mm
- prolunghe att. 1/2": 125 + 250 mm
- leva a t con quadro Scorrevole 3/8 " F, 1/2" M
- adattatore portainseri esagonali att. 1/4", att. Quadro 1/4"
- martello tipo tedesco 300 g, manico HICKORY, DIN 1041
- flessometro 5 m, 19 mm
- chiavi a L esagonali, finitura satinata, in supporto pieghevole: 1,5 - 2 - 2,5 - 3 - 4 - 5 - 6 - 8 - 10 mm
- chiavi a L Torx, finitura satinata, in supporto pieghevole: Tx10 - Tx15 - Tx20 - Tx25 - Tx27 - Tx30 - Tx40 - Tx45 - Tx50
- cacciavite:
- PH 1 x 75 mm; PH 2 x 100 mm
- taglio: 5,0 x 0,8 x 75 mm; 6,5 x 1,2 x 100 mm
- impugnatura porta inserti att. 1/4" 200 mm
- box inserti colorati att. 1/4 "
- PZ 1 - 2 - 3; PH 1 - 2 - 3
- Taglio 3 - 4 - 5 - 6 mm
- Torx: Tx10 - Tx15 - Tx20 - Tx25 - Tx27 - Tx30 - Tx40
- Esagono: 3 - 4 - 5 - 6 mm
- Adattatore Portainseri quadro femmina 1/4 " - 1/4" esagonale
- Portainseri gancio rapido
- cutter con lama retrattile da 18 mm
- tester di tensione con clip, 125 - 250V, 140 mm
- livella a bolla a 3 vie, in alluminio
- tenaglia, 250 mm
- pinza regolabile 250 mm, impugnatura bi-componente
- forbici 180 mm, impugnatura bi-componente
- pinze professionali 180 mm, impugnatura bi-componente
- pinze becchi lunghi 160 mm, impugnatura bi-componente
- tronchese taglio diagonale 160 mm
- pinza per crimpare 235 mm
- assortimento 30 terminali
- chiavi combinate, cromate, estremità lucide: 8 - 10 - 11 - 12 - 13-15 - 17 - 19 mm
- chiave a rullino 8 "
- pinza per seeger interni: 165 mm
- pinza per seeger esterni 165 mm
- 260 mm Sega, lame 150 millimetri
- 150 mm lame, 3 pezzi

• valigetta in alluminio rinforzata

RICAMBI

articolo	DESCRIZIONE	Euro
BGS 15501-LEER	VALIGETTA VUOTA PER SET BGS 15501	162,38



NEW POLLICI

NEW



BUSSOLE ESAGONALI



BUSSOLE ESAGONALI



BGS articolo	DESCRIZIONE	Euro
BGS 9191	SET 2 CASSETTE, 174 CHIAVI A BUSSOLA ESAGONALI, ATT. 1/4" + 1/2"	172,90

CARATTERISTICHE

- comprende due set attacco 1/4" e 1/2"
- comprende i seguenti utensili attacco 1/4":
 - cricchetto reversibile, 72 denti, con pulsante di sgancio rapido
 - prolunga, 50 mm
 - leva con quadro scorrevole
 - impugnatura 150 mm
 - bussole esagonali: 4-4.5-5-5.5-6-7-8-9-10-11-12-13-14 mm
 - 1 adattatore portainseri 1/4" esagonale
 - inserti attacco esagonale 1/4", lunghezza 50 mm: PZ1-PZ2 - Taglio 4 e 6 mm
 - inserto speciale per viti a occhio
 - inserti esagonali in pollici, attacco 1/4": 1/16"-5/64"-3/32"-7/64"-1/8"-9/64"-5/32"-3/16"-7/32"-1/4"
 - inserti esagonali con foro in pollici, attacco 1/4": 5/64"-3/32"-7/64"-1/8"-9/64"-5/62"
 - inserti esagonali metrici, attacco 1/4": 1.5-2-2.5-3-4-5-5.5-6-8 mm
 - inserti esagonali metrici con foro, attacco 1/4": 2-2.5-3-4-5-6 mm
 - inserti spanner, attacco 1/4": 4-6-8-10 mm
 - inserti Torx, attacco 1/4": TX8-TX10-TX15-TX20-TX25-TX27-TX30-TX35-TX40
 - inserti Torx con foro, attacco 1/4": TH8-TH10-TH15-TH20-TH25-TH27-TH30-TH35-TH40
 - inserti xzn, attacco 1/4": 5-6-8
 - inserti Quadro, attacco 1/4": S0-S1-S2-S3
 - inserti PZ, attacco 1/4": PZ0-PZ0-PZ1-PZ1-PZ2-PZ2-PZ2-PZ2-PZ3-PZ3
 - inserti PH, attacco 1/4": PH0-PH0-PH1-PH1-PH2-PH2-PH2-PH3-PH3
 - inserti Taglio, attacco 1/4": 3-4-4.5-5-5.5-6-6.5-7-8 mm
 - inserti a due tacche, attacco 1/4": C1-C2-C3
 - inserti Tri-wing, attacco 1/4": 1-2-3-4-6-8-10
 - chiavi a L esagonali: 1-1.5-2-2.5-3-4-5 mm
- comprende i seguenti utensili attacco 1/2":
 - cricchetto reversibile, 72 denti, con pulsante di sgancio rapido
 - prolunghe: 125, 200 mm
 - adattatore quadro scorrevole per uso come leva a T
 - snodo
 - bussole esagonali: 10-11-12-13-14-15-16-17-18-19-20-21-22-24-27-30-32 mm
 - inserti attacco 5/16" (8 mm): PH3-PH4 / PZ3-PZ4
 - Taglio: 8-10-12
 - Torx: TX40-TX45-TX50-TX55-TX60
 - Torx con foro: TH40-TH45-TH50-TH55-TH60
 - XZN: M8-M10-M12
 - Esagono: 7-8-10-12 mm

BGS articolo	DESCRIZIONE	Euro
BGS 9192	SET 2 CASSETTE, 174 CHIAVI A BUSSOLA ESAGONALI MISURE IN POLLICI, ATT. 1/4" + 1/2"	172,90

CARATTERISTICHE

- comprende due set attacco 1/4" e 1/2"
- comprende i seguenti utensili attacco 1/4":
 - cricchetto reversibile, 72 denti, con pulsante di sgancio rapido
 - prolunga, 50 mm
 - leva con quadro scorrevole
 - impugnatura 150 mm
 - bussole esagonali in pollici: 5/32-3/16-7/32-1/4-9/32-5/16-11/32-3/8-13/32-7/16-15/32-1/2-9/16"
 - 1 adattatore portainseri 1/4" esagonale
 - inserti attacco esagonale 1/4", lunghezza 50 mm: PZ1-PZ2 - Taglio 4 e 6 mm
 - inserto speciale per viti a occhio
 - inserti esagonali in pollici, attacco 1/4": 1/16"-5/64"-3/32"-7/64"-1/8"-9/64"-5/32"-3/16"-7/32"-1/4"
 - inserti esagonali con foro in pollici, attacco 1/4": 5/64"-3/32"-7/64"-1/8"-9/64"-5/62"
 - inserti esagonali metrici, attacco 1/4": 1.5-2-2.5-3-4-5-5.5-6-8 mm
 - inserti esagonali metrici con foro, attacco 1/4": 2-2.5-3-4-5-6 mm
 - inserti spanner, attacco 1/4": 4-6-8-10 mm
 - inserti Torx, attacco 1/4": TX8-TX10-TX15-TX20-TX25-TX27-TX30-TX35-TX40
 - inserti Torx con foro, attacco 1/4": TH8-TH10-TH15-TH20-TH25-TH27-TH30-TH35-TH40
 - inserti xzn, attacco 1/4": 5-6-8
 - inserti Quadro, attacco 1/4": S0-S1-S2-S3
 - inserti PZ, attacco 1/4": PZ0-PZ0-PZ1-PZ1-PZ2-PZ2-PZ2-PZ2-PZ3-PZ3
 - inserti PH, attacco 1/4": PH0-PH0-PH1-PH1-PH2-PH2-PH2-PH3-PH3
 - inserti Taglio, attacco 1/4": 3-4-4.5-5-5.5-6-6.5-7-8 mm
 - inserti a due tacche, attacco 1/4": C1-C2-C3
 - inserti Tri-wing, attacco 1/4": 1-2-3-4-6-8-10
 - chiavi a L esagonali: 1-1.5-2-2.5-3-4-5 mm
- comprende i seguenti utensili attacco 1/2":
 - cricchetto reversibile, 72 denti, con pulsante di sgancio rapido
 - prolunghe: 125, 200 mm
 - adattatore quadro scorrevole per uso come leva a T
 - snodo
 - bussole esagonali in pollici: 3/8"-7/16"-15/32"-1/2"-9/16"-19/32"-5/8"-11/16"-23/32"-3/4"-7/8"
 - inserti attacco 5/16" (8 mm): PH3-PH4 / PZ3-PZ4
 - Taglio: 8-10-12
 - Torx: TX40-TX45-TX50-TX55-TX60
 - Torx con foro: TH40-TH45-TH50-TH55-TH60
 - XZN: M8-M10-M12
 - Esagono: 7-8-10-12 mm

SET 1/2"



articolo	DESCRIZIONE	Euro
24108	CASSETTA 108 PEZZI, CHIAVI A BUSSOLA SURFACE DRIVE DA 1/4" & 1/2" + BUSSOLE TORX® - CHROM-VANADIUM QUALITÀ EXTRA	115,00

CARATTERISTICHE

- 13 Bussole da 1/4" surface drive: 4, 4.5, 5, 5.5, 6, 7, 8, 9, 10, 11, 12, 13, 14 mm
- 8 Bussole da 1/4" surface drive Lunghe: 6, 7, 8, 9, 10, 11, 12, 13 mm
- 5 Bussole da 1/4" Torx - E4, E5, E6, E8
- 2 Prolunghe da 1/4" - 75, 100 mm
- 1 Impugnatura porta bussole da 1/4"
- 1 Snodo 1/4"
- 1 Leva con quadro scorrevole da 1/4"
- 1 Cricchetto sgancio rapido da 1/4"
- 18 Bussole cromate da 1/4" con inserti:
 - 7 torx: TX8, TX 10, TX 15, TX20, TX25, TX27, TX30
 - 4 esagono - 3, 4, 5, 6 mm
 - 3 taglio - 4, 5.5, 6.5 mm
 - 2 Ph - 1, 2
 - 2 Pz - 1, 2
- 17 Bussole da 1/2" surface drive
 - 10, 11, 12, 13, 14, 15, 16, 17, 18, 19, 20, 21, 22, 24, 27, 30, 32 mm
- 5 Bussole da 1/2" lunghe surface drive: 14, 15, 17, 19, 22 mm
- 8 Bussole da 1/2" Torx: E10, E11, E12, E14, E16, E18, E20, E24
- 1 Cricchetto sgancio rapido da 1/2"
- 2 Prolunghe da 1/2" - 125, 250 mm
- 2 Bussole per candele 1/2": 16, 21 mm
- 1 Snodo da 1/2"
- 1 Quadro scorrevole 1/2"
- 1 Adattatore - Quadro 1/2" - Porta inserti 5/16"
- 17 Inserti 5/16":
 - 5 esagono - 7, 8, 10, 12, 14 mm
 - 3 taglio - 8, 10, 12 mm
 - 2 Ph - 3, 4
 - 2 Pz - 3, 4
 - 5 Torx - T40, T45, T50, T55, T60
- 4 Chiavi maschio esagonali piegate: 1.27, 1.5, 2, 2.5 mm

RICAMBI



articolo	DESCRIZIONE	Euro
24108-V	VALIGETTA VUOTA PER 24108/35108	21,00



articolo	DESCRIZIONE	Euro
BGS 2287	CASSETTA 108 PEZZI, CHIAVI A BUSSOLA SURFACE DRIVE DA 1/4" & 1/2" + BUSSOLE TORX® - CHROM-VANADIUM QUALITÀ EXTRA	165,10

CARATTERISTICHE

- comprende i seguenti utensili attacco 1/4":
 - 13 Bussole da 1/4" surface drive: 4, 4.5, 5, 5.5, 6, 7, 8, 9, 10, 11, 12, 13, 14 mm
 - 8 Bussole da 1/4" surface drive Lunghe: 6, 7, 8, 9, 10, 11, 12, 13 mm
 - 5 Bussole da 1/4" Torx - E4, E5, E6, E7, E8
 - 2 Prolunghe da 1/4" - 50, 100 mm
 - 1 Impugnatura porta bussole da 1/4"
 - 1 Snodo 1/4"
 - 1 Leva con quadro scorrevole da 1/4"
 - 1 Cricchetto sgancio rapido da 1/4"
 - 18 Bussole cromate da 1/4" con inserti:
 - 7 torx: TX8, TX 10, TX 15, TX20, TX25, TX27, TX30
 - 4 esagono - 3, 4, 5, 6 mm
 - 3 taglio - 4, 5.5, 6.5 mm
 - 2 Ph - 1, 2
 - 2 Pz - 1, 2
- comprende i seguenti utensili attacco 1/2":
 - 17 Bussole da 1/2" surface drive
 - 10, 11, 12, 13, 14, 15, 16, 17, 18, 19, 20, 21, 22, 24, 27, 30, 32 mm
 - 5 Bussole da 1/2" lunghe surface drive: 14, 15, 17, 19, 22 mm
 - 8 Bussole da 1/2" Torx: E10, E11, E12, E14, E16, E18, E20, E24
 - 1 Cricchetto sgancio rapido da 1/2"
 - 2 Prolunghe da 1/2" - 125, 250 mm
 - 2 Bussole per candele 1/2": 16, 21 mm
 - 1 Snodo da 1/2"
 - 1 Quadro scorrevole 1/2"
 - 1 Adattatore - Quadro 1/2" - Porta inserti 5/16"
- 17 Inserti 5/16":
 - 5 esagono - 7, 8, 10, 12, 14 mm
 - 3 taglio - 8, 10, 12 mm
 - 2 Ph - 3, 4
 - 2 Pz - 3, 4
 - 5 Torx - T40, T45, T50, T55, T60
- 4 Chiavi maschio esagonali piegate: 1.27, 1.5, 2, 2.5 mm



ESAGONALI

108 PEZZI

BUSSOLE
ESAGONALI



1/4"
1/2"

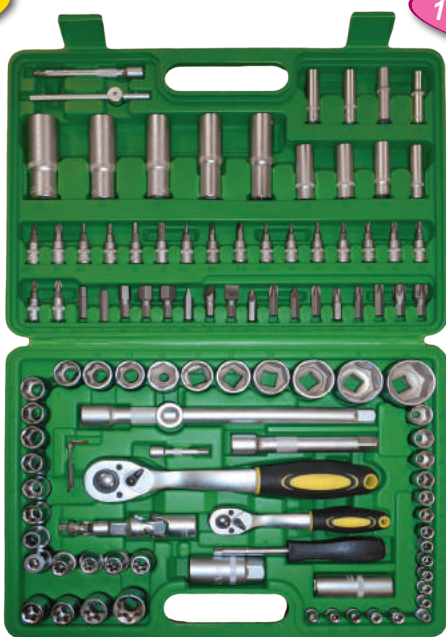

FERMEC
articolo

DESCRIZIONE

Euro

35108

**CASSETTA 108 PEZZI, CHIAVI A BUSSOLA
ESAGONALI DA 1/4" & 1/2"
+ BUSSOLE TORX® - CHROM-VANADIUM
QUALITÀ EXTRA**

120,00

CARATTERISTICHE

- 13 Bussole da 1/4" esagonali: 4, 4.5, 5, 5.5, 6, 7, 8, 9, 10, 11, 12, 13, 14 mm
- 8 Bussole da 1/4" esagonali Lunghe: 6, 7, 8, 9, 10, 11, 12, 13 mm
- 5 Bussole da 1/4" Torx - E4, E5, E6, E8
- 2 Prolunghe da 1/4" - 75, 100 mm
- 1 Impugnatura porta bussole da 1/4"
- 1 Snodo 1/4"
- 1 Leva con quadro scorrevole da 1/4"
- 1 Cricchetto sgancio rapido da 1/4"
- 18 Bussole cromate da 1/4" con inserti:
 - 4 esagono - 3, 4, 5, 6 mm
 - 3 taglio - 4, 5.5, 6.5 mm
 - 2 Ph - 1, 2
 - 2 PZ - 1, 2
- 7 Torx: T8, T10, T15, T20, T25, T27, T30
- 17 Bussole da 1/2" esagonali
10, 11, 12, 13, 14, 15, 16, 17, 18, 19, 20, 21, 22, 24, 27, 30, 32 mm
- 5 Bussole da 1/2" lunghe esagonali: 14, 15, 17, 19, 22 mm
- 8 Bussole da 1/2" Torx: E10, E11, E12, E14, E16, E18, E20, E24
- 1 Cricchetto sgancio rapido da 1/2"
- 2 Prolunghe da 1/2" - 125, 250 mm
- 2 Bussole per candele 1/2": 16, 21 mm
- 1 Snodo da 1/2"
- 1 Quadro scorrevole 1/2"
- 1 Adattatore - Quadro 1/2" - Porta inserti 5/16"
- 17 Inserti 5/16":
 - 5 esagono - 7, 8, 10, 12, 14 mm
 - 3 taglio - 8, 10, 12 mm
 - 2 Ph - 3, 4
 - 2 Pz - 3, 4
 - 5 Torx - T40, T45, T50, T55, T60
- 4 Chiavi maschio esagonali piegate: 1.27, 1.5, 2, 2.5 mm

ESAGONALI

PROMO



1/4"-3/8"-1/2"

CV



BUSSOLE
ESAGONALI



BGS
articolo

DESCRIZIONE

Euro

BGS 15216

**CASSETTA 216 PEZZI, CHIAVI A BUSSOLA
ESAGONALI DA 1/4" - 3/8" - 1/2"
+ CHIAVI COMBinate 8-19 MM**

230,00

CARATTERISTICHE

- comprende i seguenti utensili con attacco 1/2":
 - cricchetto reversibile
 - 2 x prolunghe: 125, 250 mm
 - quadro scorrevole per prolunghe
 - snodo
 - 2 x bussole per candele: 16, 21 mm
 - riduzione da 3/8" a 1/2"
 - 14 x bussole Esagonali : 13-14-15-16-17-18-19-20-21-22-24-27-30-32 mm
 - 5 x bussole Esagonali lunghe: 16-17-19-21-22 mm
 - 3 x bussole Torx femmina: E20 - E22 - E24
 - bussola Torx maschio Tx-70
 - bussola Esagono maschio 14 mm
- comprende i seguenti utensili con attacco 3/8":
 - cricchetto reversibile
 - prolunga 125 mm
 - snodo
 - bussola per candele 18 mm
 - quadro scorrevole per prolunghe
 - 10 x bussole Esagonali: 10-11-12-13-14-15-16-17-18-19 mm
 - 6 x bussole Esagonali lunghe: 10-11-12-13-14-15 mm
 - 7 x bussole Torx femmina: E10- E12- E14- E16- E18
- comprende i seguenti utensili con attacco 1/4":
 - cricchetto reversibile
 - prolunghe: 50, 100 mm
 - snodo
 - chiave a T con quadro scorrevole
 - impugnatura portabussole
 - 13 x bussole Esagonali: 4-4.5-5-5.5-6-7-8-9-10-11-12-13-14 mm
 - 7 x bussole Esagonali lunghe: 4-5-6-7-8-9-10
 - 5 x bussole Torx femmina: E4 - E5 - E6 - E7 - E8
 - 30 x bussole maschio: Torx, Torx con foro, PH, PZ, Esagono, Taglio
 - 30 x inserti att. 10 mm
 - 44 x inserti att. 1/4"
 - adattatore portabussole
 - adattatori portainseriti
- 12x chiavi combinate: 8 - 19 mm
- 7x chiavi a L esagonali: 1.2 - 5 mm
- impugnatura portainseriti

RICAMBI

BGS
articolo

DESCRIZIONE

Euro

BGS 15216-1

VALIGETTA VUOTA PER SET BGS 15216

29,33

SET 1/2"

PROMO
NEW PROMO

BSG articolo	DESCRIZIONE	Euro
BGS 15217	CASSETTA 176 PEZZI. CHIAVI A BUSSELA SURFACE DRIVE DA 1/4" - 3/8" - 1/2" + CHIAVI COMBinate A CRICCHETTO 8-19 MM	286,00

CARATTERISTICHE

- comprende i seguenti utensili attacco 1/4":
 - cricchetto reversibile 72 denti
 - 13 bussole: 4-4,5-5-5,5-6-7-8-9-10-11-12-13-14 mm
 - 7 bussole lunghe: 4-5-6-7-8-9-10 mm
 - 5 bussole Torx femmina: E4-E5-E6-E7-E8
 - prolunghe: 50, 100 mm
 - snodo
 - impugnatura 150 mm
 - leva con quadro scorrevole
 - 33 bussole con maschio:
 - Taglio: 4,0-5,5-6,5-7,0 mm
 - Croce: PH: 0-1-2, PZ: 0-1-2
 - Esagono: 3-4-5-6 mm
 - Torx: TX8-TX9-TX10-TX15-TX20-TX25-TX27-TX30
 - Torx c/foro: TH8-TH9-TH10-TH15-TH20-TH25-TH27-TH30
 - XZN: M8-M10-M12
- comprende i seguenti utensili attacco 3/8":
 - cricchetto reversibile 72 denti
 - 10 bussole: 10-11-12-13-14-15-16-17-18-19 mm
 - 6 bussole lunghe: 10-11-12-13-14-15 mm
 - 5 bussole Torx femmina: E10-E11-E12-E14-E16
 - prolunga: 125 mm
 - snodo
 - adattatore portainseriti per inserti 5/16" (8 mm)
- comprende i seguenti utensili attacco 1/2":
 - cricchetto reversibile 72 denti
 - 17 bussole: 10-11-12-13-14-15-16-17-18-19-20-21-22-24-27-30-32 mm
 - 2 bussole lunghe: 16-18 mm
 - 3 bussole Torx femmina: E18-E20-E24
 - prolunga: 125 mm
 - prolunga: 250 mm con quadro scorrevole per uso come leva a T
 - snodo
 - bussole per candele 16-18-21 mm
 - adattatore portainseriti per inserti 5/16" (8 mm)
 - bussole ricoperte per cerchi in lega: 17 - 19-21 mm
- inserti attacco 5/16":
 - 3 Inserti Taglio: 8 -10-12 mm
 - 6 inserti Torx: TX40-TX45-TX50-TX55-TX60-TX70
 - 6 inserti Torx c/foro: TH40-TH45-TH50-TH55-TH60-TH70
 - Croce: PH: 3-4, PZ: 3-4
 - Esagonali: 7-8-10-12-14 mm
- chiavi a L:
 - 9 Torx c/ foro: TH10-TH15-TH20-TH25-TH27-TH30-TH40-TH45-TH50
 - 9 Esagonali: 1,5-2-2,5-3-4-5-6-8-10 mm
- **12 chiavi combinate a cricchetto:**
8-9-10-11-12-13-14-15-16-17-18-19 mm

RICAMBI

BSG articolo	DESCRIZIONE	Euro
BGS 15217-1	VALIGETTA VUOTA PER SET BGS 15217	30,00



1/4"
3/8"
1/2"

BSG articolo	DESCRIZIONE	Euro
24276	CASSETTA 176 PEZZI, CHIAVI A BUSSELA MULTIMPRONTA DA 1/4" - 3/8" - 1/2" + CHIAVI COMBinate A CRICCHETTO 8-19 MM	320,00

CARATTERISTICHE

- 13 Bussole da 1/4" MULTIMPRONTA SPLINE DRIVE: 4, 4,5, 5, 5,5, 6, 7, 8, 9, 10, 11, 12, 13, 14 mm
- 7 Bussole da 1/4" Lunghe MULTIMPRONTA SPLINE DRIVE: 4, 5, 6, 7, 8, 9, 10 mm
- 5 Bussole da 1/4" Torx - E4, E5, E6, E7, E8
- 1 Prolunga da 1/4" 50 mm
- 1 Prolunga da 1/4" testa sferica 100 mm
- 1 Cricchetto sgancio rapido da 1/4" 72 denti
- 1 Impugnatura porta bussole da 1/4"
- 1 Snodo 1/4"
- 1 Leva con quadro scorrevole da 1/4"
- 33 Bussole con inserto da 1/4":
 - 4 Brugola 3, 4, 5, 6 mm
 - 4 Taglio 4, 5,5, 6,5, 7 mm
 - 3 XZN M8, M10, M12
 - 3 PH 0, 1, 2; 3
 - PZ 0, 1, 2
 - 8 Torx TX8, TX9, TX10, TX15, TX20, TX25, TX27, TX30
 - 8 Torx con Foro TH8, TH9, TH10, TH15, TH20, TH25, TH27, TH30
- Serie 9 Chiavi a L Torx con foro T10, T15, T20, T25, T27, T30, T40, T45, T50
- Serie 9 Chiavi a L Brugola con testa sferica 1,5, 2, 2,5, 3, 4, 5, 6, 8, 10 mm
- 10 Bussole da 3/8" MULTIMPRONTA - SPLINE: 10, 11, 12, 13, 14, 15, 16, 17, 18, 19 mm
- 6 Bussole da 3/8" Lunghe MULTIMPRONTA SPLINE DRIVE: 10, 11, 12, 13, 14, 15 mm
- 6 Bussole da 3/8" Torx - E10, E11, E12, E14, E16, E18
- 1 Cricchetto sgancio rapido da 3/8" 72 denti
- 1 Prolunga da 3/8" testa sferica 125 mm
- 1 Snodo 3/8"
- 1 Bussole per candele 3/8" 18 mm
- 1 Adattatore Quadro 3/8" - Porta inserti 5/16"
- 24 Inserti 5/16" lunghi 30 mm:
 - Taglio 8, 10, 12 mm
 - Ph 3, 4
 - Pz 3, 4
 - Brugola 7, 8, 10, 12, 14 mm
 - Torx T40, T45, T50, T55, T60, T70
 - Torx con foro T40, T45, T50, T55, T60, T70
- 17 Bussole da 1/2" MULTIMPRONTA - SPLINE: 10, 11, 12, 13, 14, 15, 16, 17, 18, 19, 20, 21, 22, 24, 27, 30, 32 mm
- 2 Bussole da 1/2" lunghe MULTIMPRONTA - SPLINE (16, 18 mm)
- 2 Bussole da 1/2" Torx (E20, E24)
- 3 Bussole da 1/2" Impact con rivestimento in plastica: 17, 19, 21 mm
- 1 Cricchetto sgancio rapido da 1/2" 72 denti
- 1 Prolunga da 1/2" 125 mm
- 1 Prolunga da 1/2" testa sferica 250 mm
- 2 Bussole per candele 1/2" 16, 21 mm
- 1 Adattatore - Quadro 1/2" - Porta inserti 5/16"
- 12 Chiavi Combinate a cricchetto 8, 9, 10, 11, 12, 13, 14, 15, 16, 17, 18, 19 mm



BGS articolo	DESCRIZIONE	Euro
BGS 8820	CASSETTA 218 PEZZI, CHIAVI A BUSSOLA SURFACE DRIVE DA 1/4" - 3/8" - 1/2" + CHIAVI COMBinate A CRICCHETTO 8-19 MM	535,00

CARATTERISTICHE

- comprende i seguenti utensili attacco 1/4":
 - cricchetto reversibile
 - 13 bussole: 4 - 4,5 - 5 - 5,5 - 6 - 7 - 8 - 9 - 10 - 11 - 12 - 13 - 14 mm
 - 7 bussole lunghe: 4 - 5 - 6 - 7 - 8 - 9 - 10 mm
 - 5 bussole Torx femmina: E4 - E5 - E6 - E7 - E8
 - prolunghe: 50, 100 mm
 - snodo
 - impugnatura 150 mm
 - leva con quadro scorrevole
 - 33 bussole con maschio:
 - Taglio: 4,0 - 5,5 - 6,5 - 7,0 mm
 - Croce: PH: 0 - 1 - 2, PZ: 0 - 1 - 2
 - Esagono: 3 - 4 - 5 - 6 mm
 - Torx: TX8 - TX9 - TX10 - TX15 - TX20 - TX25 - TX27 - TX30
 - Torx c/foro: TH8 - TH9 - TH10 - TH15 - TH20 - TH25 - TH27 - TH30
 - XZN: M8 - M10 - M12
- comprende i seguenti utensili attacco 3/8":
 - cricchetto reversibile
 - 10 bussole: 10-11-12-13-14-15-16-17-18-19 mm
 - 6 bussole lunghe: 10-11-12-13-14-15 mm
 - 6 bussole Torx femmina: E10 - E11 - E12 - E14 - E16 - E18
 - prolunga: 125 mm
 - snodo
 - bussola per candele 18 mm
 - adattatore portainseriti per inserti 5/16" (8 mm)
- comprende i seguenti utensili attacco 1/2":
 - cricchetto reversibile
 - 17 bussole: 10-11-12-13-14-15-16-17-18-19-20-21-22-24-27-30-32 mm
 - 2 bussole lunghe: 16-18 mm
 - 2 bussole Torx femmina: E20-E24
 - prolunga: 125 mm
 - prolunga: 250 mm con quadro scorrevole per uso come leva a T
 - snodo
 - bussole per candele 16 - 21 mm
 - adattatore portainseriti per inserti 5/16" (8 mm)
 - bussole ricoperte per cerchi in lega: 17- 19 - 21 mm
- inserti attacco 5/16:
 - 6 inserti Torx: TX40 - TX45 - TX50 - TX55 - TX60 - TX70
 - 6 inserti Torx c/foro: TH40 - TH45 - TH50 - TH55 - TH60 - TH70
 - Croce: PH: 3 - 4, PZ: 3 - 4
 - Esagonali: 7-8-10-12-14 mm
- chiavi a L:
 - 9 Torx c/ foro: TH10 - TH15 - TH20 - TH25 - TH27 - TH30 - TH40 - TH45 - TH50
 - 9 Esagonali: 1,5 - 2 - 2,5 - 3 - 4 - 5 - 6 - 8 - 10 mm
- 12 chiavi combinate a cricchetto: 8-9-10-11-12-13-14-15-16-17-18-19 mm

BGS articolo	DESCRIZIONE	Euro
BGS 8820-LEER	VALIGETTA VUOTA PER SET BGS 88200	42,08



BGS articolo	DESCRIZIONE	Euro
BGS 2290	CASSETTA 218 PEZZI, CHIAVI A BUSSOLA MULTIMPRONTA DA 1/4" - 3/8" - 1/2" + CHIAVI COMBinate A CRICCHETTO 8-19 MM	535,00

CARATTERISTICHE

- comprende i seguenti utensili attacco 1/4":
 - cricchetto reversibile 72 denti
 - 13 bussole: 4 - 4,5 - 5 - 5,5 - 6 - 7 - 8 - 9 - 10 - 11 - 12 - 13 - 14 mm
 - 7 bussole lunghe: 4 - 5 - 6 - 7 - 8 - 9 - 10 mm
 - 5 bussole Torx femmina: E4 - E5 - E6 - E7 - E8
 - prolunghe: 50, 100 mm
 - snodo
 - impugnatura 150 mm
 - leva con quadro scorrevole
 - 33 bussole con maschio:
 - Taglio: 4,0 - 5,5 - 6,5 - 7,0 mm
 - Croce: PH: 0 - 1 - 2, PZ: 0 - 1 - 2
 - Esagono: 3 - 4 - 5 - 6 mm
 - Torx: TX8 - TX9 - TX10 - TX15 - TX20 - TX25 - TX27 - TX30
 - Torx c/foro: TH8 - TH9 - TH10 - TH15 - TH20 - TH25 - TH27 - TH30
 - XZN: M8 - M10 - M12
- comprende i seguenti utensili attacco 3/8":
 - cricchetto reversibile 72 denti
 - 10 bussole: 10-11-12-13-14-15-16-17-18-19 mm
 - 6 bussole lunghe: 10-11-12-13-14-15 mm
 - 5 bussole Torx femmina: E10 - E11 - E12 - E14 - E16
 - prolunga: 125 mm
 - snodo
 - adattatore portainseriti per inserti 5/16" (8 mm)
- comprende i seguenti utensili attacco 1/2":
 - cricchetto reversibile 72 denti
 - 17 bussole: 10-11-12-13-14-15-16-17-18-19-20-21-22-24-27-30-32 mm
 - 2 bussole lunghe: 16-18 mm
 - 3 bussole Torx femmina: E18 - E20 - E24
 - prolunga: 125 mm
 - prolunga: 250 mm con quadro scorrevole per uso come leva a T
 - snodo
 - bussole per candele 16 - 18 - 21 mm
 - adattatore portainseriti per inserti 5/16" (8 mm)
 - bussole ricoperte per cerchi in lega: 17- 19 - 21 mm
- inserti attacco 5/16:
 - 3 Inserti Taglio: 8 - 10 - 12 mm
 - 6 inserti Torx: TX40 - TX45 - TX50 - TX55 - TX60 - TX70
 - 6 inserti Torx c/foro: TH40 - TH45 - TH50 - TH55 - TH60 - TH70
 - Croce: PH: 3 - 4, PZ: 3 - 4
 - Esagonali: 7-8-10-12-14 mm
- chiavi a L:
 - 9 Torx c/ foro: TH10 - TH15 - TH20 - TH25 - TH27 - TH30 - TH40 - TH45 - TH50
 - 9 Esagonali: 1,5 - 2 - 2,5 - 3 - 4 - 5 - 6 - 8 - 10 mm
- 12 chiavi combinate a cricchetto: 8-9-10-11-12-13-14-15-16-17-18-19 mm

BGS articolo	DESCRIZIONE	Euro
BGS 2290-LEER	VALIGETTA VUOTA PER SET BGS 2290	63,75

ESAGONALI
**IDEALE PER
ASSISTENZA E
MANUTENZIONE
AUTOMOTIVE**

 1/4"
 3/8"
 1/2"

CV
PRO +

BGS

articolo

DESCRIZIONE
Euro
BGS 2259
**CASSETTA 213 PEZZI, CHIAVI A BUSSOLA
ESAGONALI DA 1/4" - 3/8" - 1/2"
+ CHIAVI COMBinate A CRICCHETTO 8-19 MM**
597,50
CARATTERISTICHE

- comprende i seguenti utensili attacco 1/4":
 - cricchetto reversibile
 - 13 bussole: 4 - 4,5 - 5 - 5,5 - 6 - 7 - 8 - 9 - 10 - 11 - 12 - 13 - 14 mm
 - 7 bussole lunghe: 4 - 5 - 6 - 7 - 8 - 9 - 10 mm
 - 5 bussole Torx femmina: E4 - E5 - E6 - E7 - E8
 - prolunghe: 50, 100 mm
 - snodo
 - impugnatura 150 mm
 - leva con quadro scorrevole
 - adattatore portainseriti per inserti att. 1/4"
 - bussole con maschio
- comprende i seguenti utensili attacco 3/8":
 - cricchetto reversibile 72 denti
 - 10 bussole: 10-11-12-13-14-15-16-17-18-19 mm
 - 6 bussole lunghe: 10-11-12-13-14-15 mm
 - 5 bussole Torx femmina: E10 - E11 - E12 - E14 - E16 - E18
 - prolunga: 125 mm
 - snodo
 - adattatore portainseriti per inserti 5/16" (8 mm) e 10 mm
 - bussola per candele: 18 mm
- comprende i seguenti utensili attacco 1/2":
 - cricchetto reversibile 72 denti
 - 17 bussole: 10-11-12-13-14-15-16-17-18-19-20-21-22-24-27-30-32 mm
 - 2 bussole lunghe: 16-17-18-19-22 mm
 - 3 bussole Torx femmina: E20 - E24
 - prolunga: 125, 250 mm
 - quadro scorrevole per uso come leva a T di prolunghe
 - snodo
 - bussole per candele: 16 - 21 mm
 - adattatore portainseriti per inserti 10 e 14 mm
- inserti attacco 14 mm:
 - inserti Torx: TX70 x 30 mm - TX70 x 115 mm
 - inserti Torx c/foro: TH70 x 30 mm
 - XZN: M14 x 40 mm - M14 x 115 mm
 - Esagonali: 14 mm x 30 mm - 13 mm x 115 mm
- inserti attacco 10 mm:
 - inserti Torx + Torx c/ foro: T55 - T60
 - Esagonali: 10-12 mm
- inserti attacco 5/16":
 - 3 Inserti Taglio: 8 - 10 - 12 mm
 - inserti Torx + Torx c/ foro: T40 - T45 - T50
 - Croce: PH: 3 - 4, PZ: 3 - 4
 - Esagonali: 7-8 mm
- inserti attacco 1/4":
 - Torx: TX5-TX6-TX7
 - Torx c/ foro: TH7
 - 5 Ribe: M5-M6-M7-M8-M9
 - 3 XZN: M5-M6-M8
 - 5 Punte con foro: TS10-TS15-TS20-TS25-TS27-TS30-TS40-TS45-TS50
 - Esagonali: 2-2,5 mm
- chiavi a L Esagonali: 1,27 - 1,5 - 2 - 2,5 - 3 - 4 - 5 mm
- chiavi combinate: 8-9-10-12-13-14-17-19 mm

 1/4"
 1/2"

**IDEALE PER
ASSISTENZA E
MANUTENZIONE
AUTOMOTIVE**

FERMEC
 articolo

DESCRIZIONE
Euro
2608
**CASSETTA CHIAVI A BUSSOLA CON TUTTE LE
IMPRONTE ALL'INTERNO DELLA CASSETTA
INFORMAZIONI SULL'UTILIZZO DELLE CHIAVI
PER OGNI MODELLO DI AUTO**
161,00
CARATTERISTICHE

- n° 6 BUSSOLE TORX
 - TX40 x 140 MM: SEAT, AUDI, VW, SKODA
 - TX45 x 140 MM: OPEL, GM
 - TX50 x 140 MM: FORD, CITROEN, PEUGEOT, RENAULT
 - TX55 x 140 MM: FORD, MERCEDES, OPEL, RENAULT
 - TX60 x 140 MM: FORD, MERCEDES, VW, AUDI, SEAT
 - TX70 x 140 MM: NISSAN, TOYOTA, MAZDA, FORD.
- n° 7 BUSSOLE XZN:
 - M9 X 100 MM: TOYOTA, SEAT, AUDI, VW
 - M10 X 140 MM: MERCEDES, AUDI, VW, SEAT, SKODA, OPEL
 - M12 X 140 MM: MERCEDES, CHRYSLER
 - M14 X 140 MM: FORD, BMW, SEAT, AUDI, VW, SKODA, PORSCHE, ROVER, JEEP, MERCEDES
 - M16 X 100 MM C/FORO: FORD, PORSCHE, SEAT, AUDI, VW, SKODA
 - M18 X 78 MM: SEAT, VW, AUDI
 - M16 X 55 MM C/FORO: SEAT, AUDI, VW, SKODA
- n° 1 ESAGONO TESTA SFERICA
 - H5 X 160 MM: VW GOLF
- n° 4 RIBE:
 - R7 X 240 MM: FIAT, ALFA
 - R8 X 240 MM: FIAT, ALFA
 - R9 X 100 MM: SEAT, AUDI, VW, SKODA
 - R10 X 140 MM: VW, AUDI, SEAT, FIAT
- n° 9 ESAGONO:
 - H10 X 140 MM: MAZDA, MERCEDES, TOYOTA, SEAT, NISSAN, RENAULT
 - H11 X 140 MM: AUDI, VW, SEAT
 - H13 X 140 MM: AUDI, VW, SEAT
 - H7 X 230 MM: FORD, VW, AUDI
 - H14-17-19-22-24 X 50 MM: SEAT, AUDI, VW, SKODA, FORD, FIAT, ALFA, LANCIA, OPEL, MERCEDES, CITROEN, PEUGEOT, RENAULT
- n° 2 TOR X C/FORO:
 - T30 X 300 MM: AIRBAG, VW, AUDI
 - T80 X 100 MM: BMW
- n° 9 5 PUNTE C/FORO ATT. 1/4":
 - TS10-15-20-25-27-30-40-45-50: MERCEDES



ESAGONALI

BUSSOLE
ESAGONALI



1/4"
3/8"
1/2"



CV

PRO+

BGS
articolo

BGS 2243

DESCRIZIONE

**CASSETTA 192 PEZZI, CHIAVI A BUSSOLA
ESAGONALI DA 1/4" - 3/8" - 1/2"**

Euro

249,88

CARATTERISTICHE

- comprende i seguenti utensili attacco 1/4":
 - cricchetto reversibile 72 denti
 - 13 bussole: 4 - 4,5 - 5 - 5,5 - 6 - 7 - 8 - 9 - 10 - 11 - 12 - 13 - 14 mm
 - 7 bussole lunghe: 4 - 5 - 6 - 7 - 8 - 9 - 10 mm
 - 5 bussole Torx femmina: E4 - E5 - E6 - E7 - E8
 - prolunghe: 50, 100 mm
 - snodo
 - impugnatura 150 mm
 - leva con quadro scorrevole
 - adattatore portainseriti per inserti att. 1/4"
 - bussole con maschio:
 - Taglio: 4,0 - 5,5 - 6,5 - 7,0 mm
 - Croce: PH: 0 - 1 - 2, PZ: 0 - 1 - 2
 - Esagono: 3 - 4 - 5 - 6 mm
 - Torx: TX8 - TX9 - TX10 - TX15 - TX20 - TX25 - TX27 - TX30
 - Torx c/foro: TH8 - TH9 - TH10 - TH15 - TH20 - TH25 - TH27 - TH30
- comprende i seguenti utensili attacco 3/8":
 - cricchetto reversibile 72 denti
 - 10 bussole: 10-11-12-13-14-15-16-17-18-19 mm
 - 6 bussole lunghe: 10-11-12-13-14-15 mm
 - 5 bussole Torx femmina: E10 - E11 - E12 - E14 - E16
 - prolunga: 125 mm
 - snodo
 - adattatore portainseriti per inserti 5/16" (8 mm)
 - bussola per candele: 18 mm
- comprende i seguenti utensili attacco 1/2":
 - cricchetto reversibile 72 denti
 - 17 bussole: 10-11-12-13-14-15-16-17-18-19-20-21-22-24-27-30-32 mm
 - 2 bussole lunghe: 16-17-18-19-22 mm
 - 3 bussole Torx femmina: E18 - E20 - E24
 - prolunga: 125, 250 mm
 - quadro scorrevole per uso come leva a T di prolunghe
 - snodo
 - bussole per candele: 16 - 21 mm
 - adattatore portainseriti per inserti 5/16" (8 mm)
- inserti attacco 5/16":
 - 3 Inserti Taglio: 8 - 10 - 12 mm
 - 6 inserti Torx: TX40 - TX45 - TX50 - TX55 - TX60 - TX70
 - 6 inserti Torx c/foro: TH40 - TH45 - TH50 - TH55 - TH60 - TH70
 - Croce: PH: 3 - 4, PZ: 3 - 4
 - Esagonali: 7-8-10-12-14 mm
- inserti attacco 1/4":
 - Torx: TX5-TX6-TX7-TX10-TX15-TX20-TX25-TX27-TX30-TX40
 - Torx c/ foro: TH5-TH6-TH7-TH10-TH15-TH20-TH25-TH27-TH30-TH40
 - 5 Ribe: M5-M6-M7-M8-M9
 - 3 XZN: M5-M6-M8
 - 5 Punte con foro: TS7-TS10-TS15-TS20-TS25-TS27-TS30-TS40-TS45
 - Croce: PH: 3 - 4, PZ: 3 - 4
 - Esagonali: 2-2,5 mm
- chiavi a L Esagonali: 1 - 1,5 - 2 - 2,5 - 3 - 4 - 5 mm

POLIGONALI

BUSSOLE
POLIGONALI



1/4"
3/8"
1/2"



CV

PRO+

BGS
articolo

BGS 2286

DESCRIZIONE

**CASSETTA 192 PEZZI, CHIAVI A BUSSOLA
POLIGONALI DA 1/4" - 3/8" - 1/2"**

Euro

308,75

CARATTERISTICHE

- comprende i seguenti utensili attacco 1/4":
 - cricchetto reversibile 72 denti
 - 13 bussole: 4 - 4,5 - 5 - 5,5 - 6 - 7 - 8 - 9 - 10 - 11 - 12 - 13 - 14 mm
 - 7 bussole lunghe: 4 - 5 - 6 - 7 - 8 - 9 - 10 mm
 - 5 bussole Torx femmina: E4 - E5 - E6 - E7 - E8
 - prolunghe: 50, 100 mm
 - snodo
 - impugnatura 150 mm
 - leva con quadro scorrevole
 - adattatore portainseriti per inserti att. 1/4"
 - bussole con maschio:
 - Taglio: 4,0 - 5,5 - 6,5 - 7,0 mm
 - Croce: PH: 0 - 1 - 2, PZ: 0 - 1 - 2
 - Esagono: 3 - 4 - 5 - 6 mm
 - Torx: TX8 - TX9 - TX10 - TX15 - TX20 - TX25 - TX27 - TX30
 - Torx c/foro: TH8 - TH9 - TH10 - TH15 - TH20 - TH25 - TH27 - TH30
- comprende i seguenti utensili attacco 3/8":
 - cricchetto reversibile 72 denti
 - 10 bussole: 10-11-12-13-14-15-16-17-18-19 mm
 - 6 bussole lunghe: 10-11-12-13-14-15 mm
 - 5 bussole Torx femmina: E10 - E11 - E12 - E14 - E16 - E18
 - prolunga: 125 mm
 - snodo
 - adattatore portainseriti per inserti 5/16" (8 mm)
 - bussola per candele: 18 mm
- comprende i seguenti utensili attacco 1/2":
 - cricchetto reversibile 72 denti
 - 17 bussole: 10-11-12-13-14-15-16-17-18-19-20-21-22-24-27-30-32 mm
 - 2 bussole lunghe: 16-17-18-19-22 mm
 - 3 bussole Torx femmina: E20 - E24
 - prolunga: 125, 250 mm
 - quadro scorrevole per uso come leva a T di prolunghe
 - snodo
 - bussole per candele: 16 - 21 mm
 - adattatore portainseriti per inserti 5/16" (8 mm)
- inserti attacco 5/16":
 - 3 Inserti Taglio: 8 - 10 - 12 mm
 - 6 inserti Torx: TX40 - TX45 - TX50 - TX55 - TX60 - TX70
 - 6 inserti Torx c/foro: TH40 - TH45 - TH50 - TH55 - TH60 - TH70
 - Croce: PH: 3 - 4, PZ: 3 - 4
 - Esagonali: 7-8-10-12-14 mm
- inserti attacco 1/4":
 - Torx: TX5-TX6-TX7
 - 5 Ribe: M5-M6-M7-M8-M9
 - 3 XZN: M5-M6-M8
 - 5 Punte con foro: TS7-TS10-TS15-TS20-TS25-TS27-TS30-TS40-TS45
 - Croce: PH: 3 - 4, PZ: 3 - 4
 - Esagonali: 2-2,5 mm
- chiavi a L Esagonali: 1 - 1,5 - 2 - 2,5 - 3 - 4 - 5 mm

POLLICI

NEW



1/4"
3/8"
1/2"

BGS articolo	DESCRIZIONE	Euro
BGS 2245	CASSETTA 192 PEZZI, CHIAVI A BUSSOLA ESAGONALI DA 1/4" - 3/8" - 1/2", IN POLLICI	287,38

CARATTERISTICHE

- chiavi a L Esagonali: 1.27 - 1.5 - 2 - 2.5 - 3 - 4 - 5 mm
- inserti attacco 5/16":
 - Taglio: 8 - 10 - 12 mm
 - PH: PH3 - PH4 - PZ3 - PZ4
 - Esagonali: 9/32"-5/16"-3/8"-15/32"-9/16"
 - Torx: TX 40 - 45 - 50 - 55 - 60 - 70
 - Torx c/ foro: TH 40 - 45 - 50 - 55 - 60 - 70
- inserti attacco 1/4":
 - Torx: TX 5 - 6 - 7 - 10 - 15 - 20 - 25 - 27 - 30 - 40
 - Torx c/foro: TH 7 - 10 - 15 - 20 - 25 - 27 - 30 - 40
 - Ribe: 5 - 6 - 7 - 8 - 9
 - XZN: 5 - 6 - 8
 - 5 Punte con foro: TS 10 - 15 - 20 - 25 - 27 - 30 - 40 - 45
 - PH: PH1 - PH2 - PZ1 - PZ2
 - Esagonali: 2 - 2.5 mm
- comprende i seguenti utensili attacco 1/4":
 - cricchetto reversibile
 - leva con quadro scorrevole
 - prolunghe: 50, 100 mm
 - snodo
 - impugnatura 150 mm
 - bussole: 5/32"-3/16"-3/16"-7/32"-1/4"-9/32"-5/16"-11/32"-3/8"-7/16"-15/32"-1/2"-9/16"
 - bussole lunghe: 5/32"-3/16"-1/4"-9/32"-5/16"-11/32"-3/8"
 - 5 bussole Torx femmina: E4 - E5 - E6 - E7 - E8
 - adattatore portainseriti per inserti att. 1/4"
 - bussole con maschio:
 - Torx: TX8-9-10-15-20-25-27-30
 - Torx c/foro: TH8-9-10-15-20-25-27-30
 - Esagonali: 3-4-5-6 mm
 - PH: PH0-PH1-PH2
 - PZ: PZ0-PZ1-PZ2
 - Taglio: 4-5-5-6-5-7 mm
- comprende i seguenti utensili attacco 3/8":
 - cricchetto reversibile
 - prolunga: 125 mm
 - snodo
 - bussola per candele: 18 mm
 - bussole: 3/8"-7/16"-15/32"-1/2"-9/16"-19/32"-5/8"-11/16"-3/4"-25/32"
 - bussole lunghe: 3/8"-7/16"-15/32"-1/2"-9/16"-19/32"
 - 5 bussole Torx femmina: E10 - E11 - E12 - E14 - E16 - E18
- comprende i seguenti utensili attacco 1/2":
 - cricchetto reversibile
 - prolunga: 125, 250 mm
 - quadro scorrevole per uso come leva a T di prolunghe
 - adattatore portainseriti per inserti 5/16"
 - snodo
 - bussole per candele: 16 - 21 mm
 - 17 bussole: 3/8"-7/16"-15/32"-1/2"-9/16"-19/32"-5/8"-21/32"-11/16"-3/4"-25/32"-13/16"-7/8"-15/16"-1-1/16"-1-3/16"-1-1/4"
 - 2 bussole lunghe: 5/8", 11/16", 3/4", 13/16", 7/8"
 - bussole Torx femmina: E20 - E24

SURFACE DRIVE

BUSSOLE SURFACE DRIVE



1/4"
3/8"
1/2"



BGS articolo	DESCRIZIONE	Euro
BGS 2292	CASSETTA 192 PEZZI, CHIAVI A BUSSOLA SURFACE DRIVE DA 1/4" - 3/8" - 1/2"	249,88

CARATTERISTICHE

- comprende i seguenti utensili attacco 1/4":
 - cricchetto reversibile 72 denti
 - 13 bussole: 4 - 4,5 - 5 - 5,5 - 6 - 7 - 8 - 9 - 10 - 11 - 12 - 13 - 14 mm
 - 7 bussole lunghe: 4 - 5 - 6 - 7 - 8 - 9 - 10 mm
 - 5 bussole Torx femmina: E4 - E5 - E6 - E7 - E8
 - prolunghe: 50, 100 mm
 - snodo
 - impugnatura 150 mm
 - leva con quadro scorrevole
 - adattatore portainseriti per inserti att. 1/4"
 - bussole con maschio
- comprende i seguenti utensili attacco 3/8":
 - cricchetto reversibile 72 denti
 - 10 bussole: 10-11-12-13-14-15-16-17-18-19 mm
 - 6 bussole lunghe: 10-11-12-13-14-15 mm
 - 5 bussole Torx femmina: E10 - E11 - E12 - E14 - E16
 - prolunga: 125 mm
 - snodo
 - adattatore portainseriti per inserti 5/16" (8 mm)
 - bussola per candele: 18 mm
- comprende i seguenti utensili attacco 1/2":
 - cricchetto reversibile 72 denti
 - 17 bussole: 10-11-12-13-14-15-16-17-18-19-20-21-22-24-27-30-32 mm
 - 2 bussole lunghe: 16-17-18-19-22 mm
 - 3 bussole Torx femmina: E18 - E20 - E24
 - prolunga: 125, 250 mm
 - quadro scorrevole per uso come leva a T di prolunghe
 - snodo
 - bussole per candele: 16 - 21 mm
 - adattatore portainseriti per inserti 5/16" (8 mm)
- inserti attacco 5/16":
 - 3 Inserti Taglio: 8 - 10 - 12 mm
 - 6 inserti Torx: TX40 - TX45 - TX50 - TX55 - TX60 - TX70
 - 6 inserti Torx c/foro: TH40 - TH45 - TH50 - TH55 - TH60 - TH70
 - Croce: PH: 3 - 4, PZ: 3 - 4
 - Esagonali: 7-8-10-12-14 mm
- inserti attacco 1/4":
 - 3 Inserti Taglio: 8 - 10 - 12 mm
 - 10 inserti Torx: TX5-TX6-TX7-TX10-TX15-TX20-TX25-TX27-TX30-TX40
 - 8 inserti Torx c/foro: TH7-TH10-TH15-TH20-TH25-TH27-TH30-TH40
 - 5 Ribe: M5-M6-M7-M8-M9
 - 3 XZN: M5-M6-M8
 - 5 Punte con foro: TS10-TS15-TS20-TS25-TS27-TS30-TS40-TS45
 - Croce: PH: 3 - 4, PZ: 3 - 4
 - Esagonali: 2-2.5 mm
- chiavi a L Esagonali: 1 - 1,5 - 2 - 2,5 - 3 - 4 - 5 mm

RICAMBI

BGS articolo	DESCRIZIONE	Euro
BGS 2292-LEER	VALIGETTA VUOTA PER SET BGS 2292	27,80



SURFACE DRIVE

BUSSOLE SURFACE DRIVE



1/4"
3/8"
1/2"

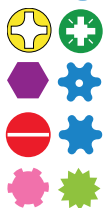

CV



NEW

BGS articolo	DESCRIZIONE	Euro
BGS 2283	CASSETTA 172 PEZZI, CHIAVI A BUSSOLA SURFACE DRIVE DA 1/4" - 3/8" - 1/2"	160,00

CARATTERISTICHE

- comprende i seguenti utensili attacco 1/4":
 - cricchetto reversibile
 - 13 bussole: 4 - 4,5 - 5 - 5,5 - 6 - 7 - 8 - 9 - 10 - 11 - 12 - 13 - 14 mm
 - 7 bussole lunghe: 4 - 5 - 6 - 7 - 8 - 9 - 10 mm
 - 5 bussole Torx femmina: E4 - E5 - E6 - E7 - E8
 - prolunghe: 50, 100 mm
 - snodo
 - impugnatura 150 mm
 - leva con quadro scorrevole
 - adattatore portainseri per inserti att. 1/4"
 - 30 bussole con maschio
- comprende i seguenti utensili attacco 3/8":
 - cricchetto reversibile
 - 10 bussole: 10-11-12-13-14-15-16-17-18-19 mm
 - 6 bussole lunghe: 10-11-12-13-14-15 mm
 - 6 bussole Torx femmina: E10 - E11 - E12 - E14 - E16 - E18
 - prolunga: 125 mm
 - snodo
 - adattatore portainseri per inserti 5/16" (8 mm)
 - bussola per candele: 18 mm
- comprende i seguenti utensili attacco 1/2":
 - cricchetto reversibile
 - 17 bussole: 10-11-12-13-14-15-16-17-18-19-20-21-22-24-27-30-32 mm
 - 2 bussole lunghe: 16-17-18-19-22 mm
 - 2 bussole Torx femmina: E18 - E20 - E24
 - prolunga: 125, 250 mm
 - quadro scorrevole per uso come leva a T di prolunghe
 - snodo
 - bussole per candele: 16 - 21 mm
 - adattatore portainseri per inserti 5/16" (8 mm)
- 24 inserti attacco 5/16":
 - 3 Inserti Taglio: 8 -10 - 12 mm
 - 6 inserti Torx: TX40 - TX45 - TX50 - TX55 - TX60 - TX70
 - 6 inserti Torx c/foro: TH40 - TH45 - TH50 - TH55 - TH60 - TH70
 - Croce: PH: 3 - 4, PZ: 3 - 4
 - Esagonali: 7-8-10-12-14 mm
- 20 inserti attacco 1/4":
 - 3 Inserti Taglio: 8 -10 - 12 mm
 - 10 inserti Torx: TX5-TX6-TX7-TX10-TX15-TX20-TX25-TX27-TX30-TX40
 - 8 inserti Torx c/foro: TH7-TH10-TH15-TH20-TH25-TH27-TH30-TH40
 - 5 Ribe: M5-M6-M7-M8-M9
 - 3 XZN: M5-M6-M8
 - 5 Punte con foro: TS10-TS15-TS20-TS25-TS27-TS30-TS40-TS45
 - Croce: PH: 3 - 4, PZ: 3 - 4
 - Esagonali: 2-2,5 mm
- chiavi a L Esagonali: 1,2 - 5 mm

RICAMBI

BGS articolo	DESCRIZIONE	Euro
BGS 2283-LEER	VALIGETTA VUOTA PER SET BGS 2283	16,58



BUSSOLE MULTIMPRONTA



CV

PRO+



1/4"
3/8"
1/2"

NEW

BGS articolo	DESCRIZIONE	Euro
BGS 2247	CASSETTA 192 PEZZI, CHIAVI A BUSSOLA MULTIMPRONTA DA 1/4" - 3/8" - 1/2"	249,88

CARATTERISTICHE

- bussole "multimpronta" attacco 1/2" adatte per dadi esagonali, poligonali, misure metriche & pollici, quadri, XZN®, TORX®
- utensili conformi DIN
- attacco quadro: 1/4" , 3/8" e 1/2"
- comprende i seguenti utensili attacco 1/4":
 - cricchetto reversibile, 72 denti, con pulsante di sgancio rapido
 - leva con quadro scorrevole
 - prolunghe: 50, 100 mm
 - snodo
 - impugnatura 150 mm
 - 13 bussole "Multimpronta": 4-4,5-5-5,5-6-7-8-9-10-11-12-13-14 mm
 - 7 bussole lunghe "Multimpronta": 4-5-6-7-8-9-10 mm
 - 5 bussole tipo Torx femmina: E4-5-6-7-8
 - 1 adattatore portainseri 1/4" esagonale
 - bussole con maschio
 - PH0-1-2, PZ0-1-2
 - Taglio: 4-5,5-6,5-7 mm
 - Esagono: 3-4-5-6 mm
 - Torx: TX8-TX9-TX10-TX15-TX20-TX25-TX27-TX30
 - Torx con foro: TH8-TH9-TH10-TH15-TH20-TH25-TH27-TH30
- comprende i seguenti utensili attacco 3/8":
 - cricchetto reversibile, 72 denti, con pulsante di sgancio rapido
 - prolunga 125 mm
 - snodo
 - bussola per candele 18 mm
 - 10 bussole "Multimpronta": 10-11-12-13-14-15-16-17-18-19 mm
 - 6 bussole lunghe "Multimpronta": 10-11-12-13-14-15 mm
 - bussole tipo Torx femmina: E10-11-12-14-16
 - adattatore portainseri 5/16" (8 mm)
- comprende i seguenti utensili attacco 1/2":
 - cricchetto reversibile, 72 denti, con pulsante di sgancio rapido
 - prolunghe: 125, 250 mm
 - adattatore quadro scorrevole per uso come leva a T
 - adattatore portainseri 5/16" (8 mm)
 - snodo
 - bussole per candele: 16-21 mm
 - 17 bussole "Multimpronta": 10-11-12-13-14-15-16-17-18-19-20-21-22-24-27-30-32 mm
 - 5 bussole lunghe "Multimpronta": 16-17-18-19-22 mm
 - bussole tipo Torx femmina: E18-20-24
- inserti attacco 5/16" (8 mm):
 - Taglio: 8-10-12 mm
 - PH3-PH4-PZ3-PZ4
 - Esagono: 7-8-10-12-14 mm
 - Torx: TX40-TX45-TX50-TX55-TX60-TX70
 - Torx con foro: TH40-TH45-TH50-TH55-TH60-TH70
- inserti attacco 1/4":
 - Torx: TX5-TX6-TX7-TX10-TX15-TX20-TX25-TX27-TX30-TX40
 - Torx con foro: TH7-TH10-TH15-TH20-TH25-TH27-TH30-TH40
 - RIBE: M5-6-7-8-9, XZN: M5-6-8
 - 5 punte con foro: TS10-TS15-TS20-TS25-TS27-TS30-TS40-TS45
 - PH3-PH4-PZ3-PZ4
 - Esagono: 2-2,5 mm
- 7 chiavi a L: 1-1,5-2-2,5-3-4-5 mm

SET 1/2"



1/4"-3/8"-1/2"-3/4" 1/4"-3/8"-1/2"-3/4"

RACCORDI DI RIDUZIONE CHROM-VANADIUM

attacco: 1/4" - 3/8" - 1/2" - 3/4"

BCS articolo	FEMMINA	MASCHIO		Euro
BGS 271	1/4"	3/8"	1	3,15
BGS 269	3/8"	1/4"	1	3,15
BGS 280	3/8"	1/2"	1	3,68
BGS 270	1/2"	3/8"	1	3,68
BGS 272	1/2"	3/4"	1	8,40
BGS 274	3/4"	1/2"	1	8,40

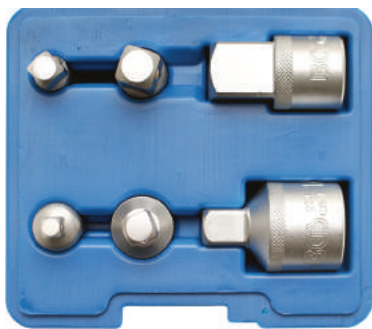

PRO+ CV

BCS articolo	DESCRIZIONE	Euro
BGS 199	SET 6 PEZZI ADATTATORI	24,23

CARATTERISTICHE

- cromati satinati

CONTENUTO

- 1/4" F X 3/8" M, coppia massima 60 Nm
- 3/8" F X 1/4" M, coppia massima 60 Nm
- 3/8" F X 1/2" M, coppia massima 200 Nm
- 1/2" F X 3/8" M, coppia massima 200 Nm
- 1/2" F X 3/4" M, coppia massima 500 Nm
- 3/4" F X 1/2" M, coppia massima 500 Nm

RICAMBI

BCS articolo	DESCRIZIONE	Euro
BGS 199-LEER	CASSETTA VUOTA	5,36



1/4"-3/8"-1/2"

BCS articolo	DESCRIZIONE	Euro
BGS 8808	SET 4 PEZZI, RIDUZIONI	10,25

CARATTERISTICHE

- comprende 4 riduzioni:
 - 1/4" F - 3/8" M
 - 3/8" F - 1/4" M
 - 3/8" F - 1/2" M
 - 1/2" F - 3/8" M
- finitura cromata satinata

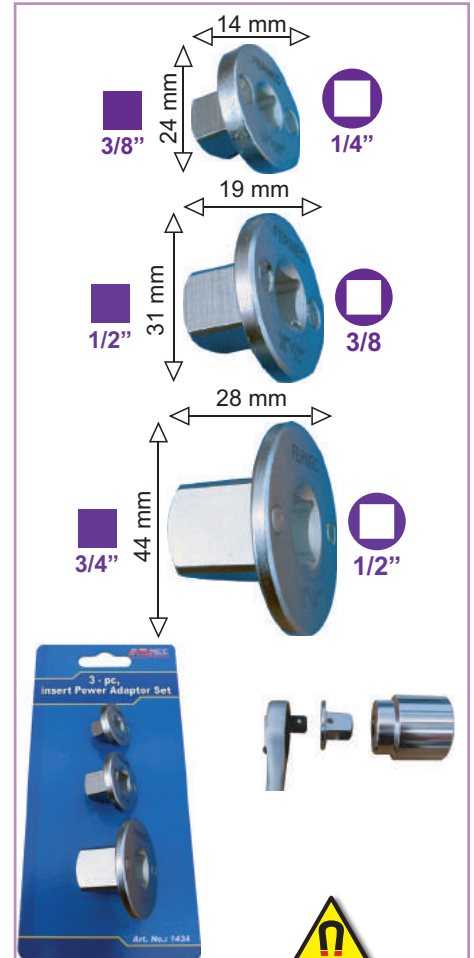

RACCORDI DI RIDUZIONE MAGNETICI A SCOMPARSA IDEALI PER CHIAVI DINAMOMETRICHE E SPAZI RIDOTTI

attacco: 1/4" - 3/8" - 1/2"

FERMEC articolo	FEMMINA	MASCHIO		Euro
1434-1/4	1/4"	3/8"	1	8,93
1434-3/8	3/8"	1/2"	1	9,98
1434-1/2	1/2"	3/4"	1	11,03
1434	SET DA 3 PEZZI IN BLISTER		1	28,35





1/2" ESAGONO

BUSSOLE SPECIALI "POWER IMPACT" - CON RIVESTIMENTO ESTERNO E PROTEZIONE INTERNA IN MATERIALE PLASTICO IDEALE PER AVVITARE BULLONI CROMATI DELLE RUOTE DI AUTOVEICOLI CON CERCHI IN LEGA

attacco: 1/2"
impronta: ESAGONO

articolo	mm	L mm		Euro
197-17-LP	17	85	1	10,50
197-19-LP	19	85	1	10,50
197-21-LP	21	85	1	10,50
197-22-LP	22	85	1	11,55
197 LPS	SET 3 PEZZI 17-19-21 mm		1	31,50



1/2" ESAGONO

DESCRIZIONE	Euro
SET 4 PEZZI BUSSOLE RIVESTITE, ATTACCO 1/2"	47,25

CARATTERISTICHE

- lunghezza: 85 mm
- bussole speciali "POWER IMPACT" con rivestimento esterno e protezione interna in materiale plastico
- ideali per avvitare bulloni cromati delle ruote di autoveicoli CON CERCHI IN LEGA
- misure: 17, 19, 21, 22 mm



NEW

1/2" ESAGONO

DESCRIZIONE	Euro
SET 5 PEZZI BUSSOLE RIVESTITE, ATT. 1/2"	63,00

CARATTERISTICHE

- lunghezza: 85 mm
- bussole speciali "POWER IMPACT" con rivestimento esterno e protezione interna in materiale plastico
- Ideali per avvitare bulloni cromati delle ruote di autoveicoli CON CERCHI IN LEGA
- misure: 15, 17, 19, 21, 22 mm



CROMO PRO+

DESCRIZIONE	Euro
SET 3 PEZZI, BUSSOLE SPECIALI RICOPERTE ATT. 1/2", 17, 19 E 21 MM	43,10
BGS 7300	
BGS 7301	17 MM 13,75
BGS 7302	19 MM 13,75
BGS 7303	21 MM 13,75

CARATTERISTICHE

- per uso a mano e a macchina
- ricoperte in plastica per prevenire danni ai cerchi
- con scanalatura e foro per spina
- ogni misura un colore
- lunghezza 85 mm



PRO+

RIVESTIMENTO PLASTICO COLORATO PER BUSSOLE

articolo	mm	Colore		Euro
BGS 7304	17		1	0,89
BGS 7305	19		1	0,89
BGS 7306	21		1	0,89

EXTRA LUNGHE



1/2" ESAGONO

SERIE BUSSOLE SPECIALI RIVESTITE EXTRA LUNGHE 130 MM PER CERCHI IN LEGA PROFONDI

attacco: 1/2"
impronta: ESAGONO

articolo	mm	L mm		Euro
1197-17 LP	17	130	1	17,33
1197-19 LP	19	130	1	17,33
1197-21 LP	21	130	1	17,33
1197-22 LP	22	130	1	17,33
1197 LPS	SET 3 PEZZI 17-19-21 mm		1	51,45



1/2"



ESAGONO

PRO +



CROMO

BUSSOLA A MACCHINA RIVESTITA IN PLASTICA

- IDONEE PER UTILIZZO A MANO E A MACCHINA
- CON COPERTURA IN PLASTICA PER PROTEZIONE DEI CERCHI IN ALLUMINIO
- CON SCANALATURA E FORO PER SPINA
- LUNGHEZZA 85 MM

BGS articolo	mm	L mm		Euro
BGS 7207	15	85	1	11,99
BGS 7201	17	85	1	11,99
BGS 7202	19	85	1	12,24
BGS 7203	21	85	1	12,50
BGS 7208	22	85	1	14,54

BGS 7200	SET 3 PEZZI 17-19-21 mm	1	38,12
----------	----------------------------	---	-------



PRO +

RIVESTIMENTO PLASTICA PER BUSSOLE

BGS articolo	mm		Euro
BGS 7209	15	1	0,89
BGS 7204	17	1	0,89
BGS 7205	19	1	0,89
BGS 7206	21	1	0,89
BGS 7198	22	1	0,77



1/2"

CROMO

PRO +



ESAGONO

BGS articolo	DESCRIZIONE	Euro
BGS 9847	SET 4 PEZZI, BUSSEOLA A MACCHINA RIVESTITA IN PLASTICA, ESAGONALI 17-19-21-22MM	47,18

CARATTERISTICHE

- idonee per utilizzo a mano e a macchina
- con scanalatura e foro per spina
- con copertura in plastica per protezione dei cerchi in alluminio
- ogni misura un colore per una più facile identificazione
- lunghezza 85 mm
- misure: 17, 19, 21, 22 mm



1/2"

PRO +

CROMO



ESAGONO

BUSSEOLE A MACCHINA RIVESTITA IN PLASTICA EXTRA LUNGHE

- IDONEE PER UTILIZZO A MANO E A MACCHINA
- CON COPERTURA IN PLASTICA PER PROTEZIONE DEI CERCHI IN ALLUMINIO
- CON SCANALATURA E FORO PER SPINA
- LUNGHEZZA 150 MM
- IL SET DA 3 PEZZI È BGS 7100

BGS articolo	mm	L mm		Euro
BGS 7101	17	150	1	29,33
BGS 7102	19	150	1	29,33
BGS 7103	21	150	1	31,88

BGS 7100	SET 3 PEZZI 17-19-21 mm	1	91,67
----------	----------------------------	---	-------

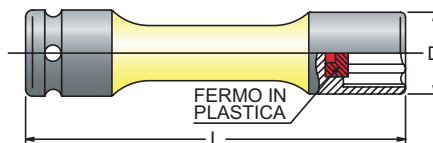
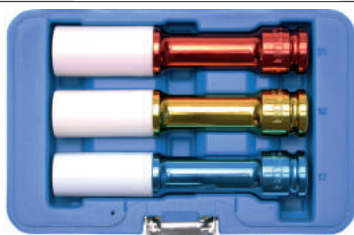

ESAGONO

CHIAVI A BUSSEOLA BOCCA ESAGONALE COLORATE

Koken articolo	mm	D mm	Colore	L mm		Euro
14145PM-17	17	23.7	Blue	110	1	31,74
14145PM-19	19	25.7	Red	110	1	31,74
14145PM-21	21	27.5	Yellow	110	1	33,44
14145PM-22	22	29		110	1	34,90



Koken articolo	DESCRIZIONE	Euro
14201M	Set 3 pezzi	93,17

CARATTERISTICHE

14145PM.110	17, 19, 21
-------------	------------





19.35 mm
16.10 mm

1/2" Mercedes-Benz

FERMEC articolo	DESCRIZIONE	Euro
MS17	BUSSOLA PER NUOVI BULLONI RUOTE MERCEDES, LUNGHEZZA 78 MM	11,55

CARATTERISTICHE

- chiave per allentare o avvitare dadi o viti ruote con profilo Socket MS 17. Montate su Mercedes
- diametro: 26 mm
- lunghezza: 78 mm

19.35 mm
16.10 mm

1/2" Mercedes-Benz

FERMEC articolo	DESCRIZIONE	Euro
MSP17	BUSSOLA CON RIVESTIMENTO IN PLASTICA PER NUOVI BULLONI RUOTE MERCEDES, LUNGHEZZA 78 MM	12,60

CARATTERISTICHE

- chiave per allentare o avvitare dadi o viti ruote con profilo Socket MS 17. Montate su Mercedes
- bussola rivestita in plastica, particolarmente idonea in presenza di cerchi in alluminio
- diametro: 27 mm
- lunghezza: 78 mm

NEW

HYUNDAI KIA

1/2" PRO+

BGS articolo	DESCRIZIONE	Euro
BGS 9371	BUSSOLA CON RIVESTIMENTO IN PLASTICA, 21 MM, PER BULLONI HYUNDAI I30, TUCSON & KIA	20,15

CARATTERISTICHE

- bussola rivestita in plastica, particolarmente idonea in presenza di cerchi in alluminio
- adatta per uso con avvitatori

NEW

23mm 5PT

LEXUS PRO+ CV

BGS articolo	DESCRIZIONE	Euro
BGS 9270	BUSSOLA SPECIALE 5 LATI, PER BULLONI DI SICUREZZA TOYOTA E LEXUS	26,78

CARATTERISTICHE

- dimensioni: 23 mm x 5 lati
- anche per uso con avvitatore

BGS 186 BGS 187

BGS 185-120 BGS 185-135 BGS 185-150

1/2" PRO+

BGS articolo	DESCRIZIONE	Euro
BGS 185	SET BARRE DI TORSIONE DA 5 PEZZI	89,12

CARATTERISTICHE

- 100 - 110 - 120 - 135 - 150 Nm
- lunghezza 195 mm

RICAMBI

BGS articolo	DESCRIZIONE	Euro
BGS 186	NEW 100 Nm	22,10
BGS 187	110 Nm	16,58
BGS 185-120	NEW 120 Nm	22,10
BGS 185-135	NEW 135 Nm	22,10
BGS 185-150	NEW 150 Nm	22,10

Non utilizzare le barre di torsione per svitare i dadi, ma solo per avvitare.

Per sicurezza, si consiglia di controllare sempre il serraggio con chiave dinamometrica.

BARRE DI TORSIONE

1/2"

BARRE DI TORSIONE CON QUADRO MASCHIO

Kokon articolo	Nm	D mm	L mm	Euro
14112-P-90Nm	90	25	208	29,67
14112-P-95Nm	95	25	202	29,67
14112-P-100Nm	100	25	196	29,67
14112-P-110Nm	110	25	213	30,31
14112-P-120Nm	120	25	201	30,31
14112-P-130Nm	130	25	203	30,31
14112-P-140Nm	140	25	205	30,31
14112-P-150Nm	150	25	205	30,31
14112-P-170Nm	170	25	195	30,31



BARRE DI TORSIONE



FAST LEAD

BARRE DI TORSIONE BOCCA FAST LEAD

Koken articolo	mm	Nm	D mm	L mm	mm	Euro
14101M-14 X 95 NM	14	95	22	208	1	27,86
14101M-15 X 110 NM	15	110	23.2	201	1	27,86
14101M-17 X 60 NM	17	60	25.7	216	1	27,86
14101M-17 X 75 NM	17	75	25.7	228	1	27,86
14101M-17 X 95 NM	17	95	25.7	214	1	27,86
14101M-17 X 110 NM	17	110	25.7	204	1	27,86
14101M-17 X 120 NM	17	120	25.7	200	1	27,86
14101M-19 X 60 NM	19	60	28.2	219	1	28,63
14101M-19 X 90 NM	19	90	28.2	223	1	28,63
14101M-19 X 110 NM	19	110	28.2	214	1	28,63
14101M-19 X 120 NM	19	120	28.2	203	1	28,63
14101M-19 X 135 NM	19	135	28.2	206	1	28,63
14101M-19 X 170 NM	19	170	28.2	190	1	28,63
14101M-21 X 100 NM	21	100	30.7	214	1	31,24
14101M-21 X 120 NM	21	120	30.7	203	1	31,24
14101M-22 X 160 NM	22	160	32	209	1	35,59

BARRE DI TORSIONE



BARRE DI TORSIONE

COLORATE



FAST LEAD

Koken articolo	mm	Nm	Colore	L mm	mm	Euro
14101MP-17 X 95 NM	17	95	Yellow	214	1	37,79
14101MP-17 X 110 NM	17	110	Red	204	1	37,79
14101MP-17 X 120 NM	17	120	Green	200	1	37,79
14101MP-19 X 90 NM	19	90	Yellow	259	1	38,56
14101MP-19 X 100 NM	19	100	Black	233	1	38,56
14101MP-19 X 120 NM	19	120	Blue	203	1	38,56
14101MP-19 X 140 NM	19	140	Orange	199	1	38,56
14101MP-21 X 100 NM	21	100	Black	214	1	41,17
14101MP-21 X 120 NM	21	120	Yellow	203	1	41,17
14101MP-22 X 150 NM	22	150	Purple	220	1	51,15

14101MP/8

 ESPOSITORE 8 PEZZI:
 17x95 Nm, 17x110 Nm,
 17x120 Nm, 19x90 Nm,
 19x100 Nm, 19x120 Nm,
 19x140 Nm, 21x100 Nm

301,40

Non utilizzare le barre di torsione per svitare i dadi, ma solo per avvitarle.

Per sicurezza, si consiglia di controllare sempre il serraggio con chiave dinamometrica.

BARRE DI TORSIONE



1"

ESAGONO

BARRE DI TORSIONE BOCCA ESAGONALE



Koken articolo	mm	Nm	D mm	L mm	mm	Euro
18101M-24 X 350 NM	24	350	43.5	300	1	114,65
18101M-27 X 350 NM	27	350	47	300	1	114,65
18101M-27 X 450 NM	27	450	47	300	1	114,65
18101M-29 X 400 NM	29	400	47.8	300	1	114,65
18101M-30 X 500 NM	30	500	51	300	1	118,83
18101M-32 X 450 NM	32	450	53.5	300	1	124,05
18101M-32 X 550 NM	32	550	53.5	300	1	124,05
18101M-32 X 600 NM	32	600	53.5	300	1	124,05
18101M-32 X 700 NM	32	700	53.5	300	1	124,05
18101M-33 X 550 NM	33	550	55	300	1	124,05
18101M-33 X 600 NM	33	600	55	300	1	124,05
18101M-33 X 650 NM (OZAT)	33	650	58.5	300	1	196,35
18101M-36 X 600 NM	36	600	58.5	300	1	139,40



BARRE DI TORSIONE



3/4"



BARRE DI TORSIONE BOCCA ESAGONALE

Koken articolo	mm	Nm	D mm	L mm	mm	Euro
16101M-24 X 180 NM	24	180	38.8	235	1	106,81
16101M-27 X 450 NM	27	450	42.5	280	1	110,41
16101M-32 X 600 NM	32	600	48.8	280	1	115,47
16101M-33 X 600 NM	33	600	50	280	1	114,70



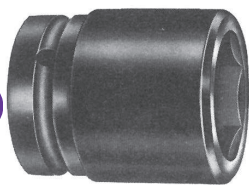

BUSSOLE "POWER IMPACT"

attacco: 1/2"
impronta: ESAGONO

articolo	mm	D mm	L mm	Euro
197-8	8	15	38	7,19
197-9	9	16,5	38	7,19
197-10	10	17,6	38	7,19
197-11	11	18,9	38	7,19
197-12	12	20,2	38	7,19
197-13	13	21,4	38	7,19
197-14	14	22,7	38	7,19
197-15	15	23,9	38	7,76
197-16	16	25	38	7,76
197-17	17	26,6	38	7,76
197-18	18	27,9	38	7,76
197-19	19	29,1	38	7,76
197-20	20	30,5	38	9,49
197-21	21	32	38	9,49
197-22	22	32,9	38	9,49
197-23	23	35	38	9,77
197-24	24	35,4	45	9,77
197-25	25	36	45	9,77
197-26	26	38	45	10,92
197-27	27	40	50	10,92
197-28	28	41	50	13,37
197-29	29	42	50	13,37
197-30	30	43	50	14,39
197-31	31	44	50	14,75
197-32	32	44	50	16,14
197-33	33	51	50	23,45
197-34	34	49	50	23,45
197-35	35	49	50	23,82
197-36	36	49	50	24,83
197-37	37	52	50	25,20
197-38	38	52	50	26,25
197-41	41	55,7	55	46,81



BUSSOLE "POWER IMPACT" ECONOMICHE

attacco: 1/2"
impronta: ESAGONO

articolo	mm	L mm	Euro
BGS 5205-8 NEW	8	38	4,08
BGS 5210	10	38	4,34
BGS 5211	11	38	4,34
BGS 5212	12	38	4,34
BGS 5213	13	38	4,34
BGS 5214	14	38	4,34
BGS 5215	15	38	4,34
BGS 5216	16	38	4,34
BGS 5217	17	38	4,34
BGS 5218	18	38	4,85
BGS 5219	19	38	4,85
BGS 5221	21	38	5,36
BGS 5222	22	38	5,61
BGS 5224	24	45	6,50
BGS 5227	27	50	8,16
BGS 5230	30	50	9,69
BGS 5232	32	50	11,73
BGS 5205-33 NEW	33	50	12,50
BGS 5205-34 NEW	34	50	16,58
BGS 5205-36 NEW	36	50	16,83
BGS 5205-38 NEW	38	50	19,13
BGS 5233	41	50	29,33



CHIAVI A BUSSOLA A MACCHINA BOCCA ESAGONALE

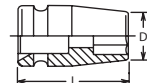

articolo	mm	D mm	L mm	Euro
14400M-8	8	14,5	38	9,68
14400M-9	9	15,7	38	9,68
14400M-10	10	17	38	9,68
14400M-11	11	18,2	38	9,68
14400M-12	12	19,5	38	9,68
14400M-13	13	20,7	38	9,68
14400M-14	14	22	38	9,68
14400M-15	15	23,2	38	10,97
14400M-16	16	24,5	38	10,97
14400M-17	17	25,7	38	10,97
14400M-18	18	27	38	10,97
14400M-19	19	28,2	38	10,97
14400M-20	20	29,5	38	12,18
14400M-21	21	30,7	38	12,18
14400M-22	22	32	38	12,18
14400M-23	23	33,2	38	13,34
14400M-24	24	34,5	38	13,34
14400M-25	25	35,7	38	13,34
14400M-26	26	37	38	15,15
14400M-27	27	38,2	40	15,15
14400M-28	28	39,5	40	16,09
14400M-29	29	40,7	42	16,09
14400M-30	30	42	42	17,71
14400M-31	31	43,2	42	18,29
14400M-32	32	44,5	42	19,75
14400M-33	33	45,7	46	28,85
14400M-34	34	47	46	28,85
14400M-35	35	48,2	46	29,43
14400M-36	36	49,5	46	29,43
NEW 14400M-38	38	52	46	33,74
14400M-41	41	55,7	55	46,37



articolo	DESCRIZIONE	Euro
BGS 5205	SET 9 PEZZI BUSSOLE A MACCHINA L. 38 MM	36,98

CARATTERISTICHE

- misure: 10-12-13-14-15-17-19-21-22-24 mm
- con foro per sfera di bloccaggio
- lunghezza 38 mm
- impact
- esagonali



CASSETTA METALLICA 12 PEZZI
10-11-12-13-14-17-19-22-24-27-30-32 MM
DIMENSIONI CASSETTA: 450 X 130 X 60 MM

attacco: 1/2"
impronta: ESAGONO

articolo	Descrizione	Euro
197112	CASSETTA METALLICA 12 PEZZI	84,00



articolo	DESCRIZIONE	Euro
14242M	Set chiavi a bussola 12 Pezzi in cassetta metallica 310 x 90 x h 48 mm	144,32
RICAMBI		
BUSSOLE	10, 11, 12, 13, 14, 15, 16, 17, 19, 21, 22, 27	

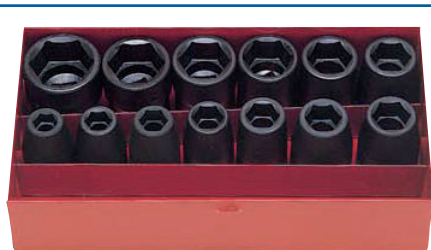

Kokon articolo	DESCRIZIONE	Euro
14241M-00	Set chiavi a bussola 13 Pezzi in cassetta metallica 196 x 100 x h 45 mm	155,21
RICAMBI		
BUSSOLE 	10, 11, 12, 13, 14, 14400M 15, 16, 17, 19, 21, 22, 24, 27	



 	 	
1/4" 1/2"	PRO+	CRO MO
BGS articolo	DESCRIZIONE	Euro
BGS 5255	SET 69 PEZZI, BUSSOLE 1/4" + 1/2"	224,88

CARATTERISTICHE

- in cromo molibdeno
- 2 cricchetti reversibili, 1/4" + 1/2", 72 denti, impugnature ergonomiche
- bussole da 1/4" esagonali: 4, 4.5, 5, 5.5, 6, 7, 8, 9, 10, 11, 12, 13 e 14 mm
- bussole da 1/4", lunghe esagonali: 6, 7, 8, 10, 11, 12 e 13 mm
- bussole da 1/2" esagonali: 10, 11, 12, 13, 14, 15, 16, 17, 18, 19, 20, 21, 22, 24, 27, 30 e 32 mm
- prolunghe 50 mm e 100 mm, attacco 1/4"
- prolunghe 125 mm e 250 mm, attacco 1/2"
- adattatore scorrevole per prolunghe da 1/2"
- leva c/quadro scorrevole da 1/4", 110 mm
- snodi: 1/4", 1/2"
- impugnatura 1/4" da 150 mm
- chiavi a bussola da 1/4" taglio 4, 5.5 e 7 mm, PH no. 1, 2 e 3, Pz no. 1, 2 e 3; esagono 3, 4, 5, 6, 7 e 8 mm Torx T10, T15, T20, T25, T30, T40



EXTRA-CORTE

	 	
BGS	DESCRIZIONE	Euro
BGS 9551	SET 9 PEZZI, BUSSOLE ESAGONALI IMPACT, EXTRA-CORTE, 13-24 MM	39,53

CARATTERISTICHE

- per uso manuale e con avvitatori a percussione
- con scanalatura e foro per spina
- extra-corte, lunghezza: 28 mm
- bussole esagonali
- attacco quadro: 1/2"
- misure:
13 - 14 - 15 - 16 - 17 - 18 - 19 - 21 - 24 mm
- su guida



EXTRA-CORTE

	 	
1/2"	PRO+	CRO MO
BGS articolo	DESCRIZIONE	Euro
BGS 9286	SET BUSSOLE DA 17 PEZZI, BUSSOLE ESAGONALI EXTRA-CORTE	82,11

CARATTERISTICHE

- misure: 8 - 9 - 10 - 11 - 12 - 13 - 14 - 15 - 16 - 17 - 18 - 19 - 20 - 21 - 22 - 23 - 24 mm
- esagonali



NEW PARETI SOTTILI

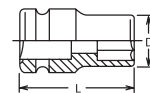

 **ESAGONO**

CHIAVI A BUSSOLA
A MACCHINA
BOCCA ESAGONALE
PARETI SOTTILI



Kokon articolo	 mm	D mm	L mm		Euro
14401M-8	8	13	38	1	9,93
14401M-9	9	14.2	38	1	9,93
14401M-10	10	15.5	38	1	9,93
14401M-11	11	16.7	38	1	9,93
14401M-12	12	18	38	1	9,93
14401M-13	13	19.2	38	1	9,93
14401M-14	14	20.5	38	1	9,93
14401M-15	15	21.7	38	1	11,28
14401M-16	16	23	38	1	11,28
14401M-17	17	24.2	38	1	11,28
14401M-18	18	25.5	38	1	11,28
14401M-19	19	26.7	38	1	11,28
14401M-20	20	28	38	1	12,49
14401M-21	21	29.2	38	1	12,49
14401M-22	22	30.5	38	1	12,49
14401M-23	23	31.7	38	1	13,67
14401M-24	24	33	38	1	13,67
14401M-25	25	34.2	38	1	13,67
14401M-26	26	35.5	38	1	15,02
14401M-27	27	36.7	40	1	15,57
14401M-28	28	38	40	1	16,53
14401M-29	29	39.2	42	1	16,53
14401M-30	30	40.5	42	1	18,18
14401M-31	31	41.7	42	1	18,78
14401M-32	32	43	42	1	20,27
14401M-33	33	44.2	46	1	29,59
14401M-34	34	45.5	46	1	29,59
NEW 14401M-35	35	46.7	46	1	30,20
NEW 14401M-36	36	48	46	1	30,20
NEW 14401M-38	38	50.5	53	1	34,65
NEW 14401M-41	41	54.2	55	1	47,60



CON RIVESTIMENTO ANTI-GRAFFIO

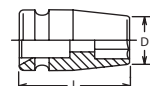

 **ESAGONO**

CHIAVI A BUSSOLA
A MACCHINA
BOCCA ESAGONALE
CON RIVESTIMENTO



Kokon articolo	 mm	D mm	L mm		Euro
14400M-10FR	10	19.5	38	1	67,02
14400M-12FR	12	22	38	1	67,02
14400M-13FR	13	23.2	38	1	67,02
14400M-14FR	14	24.8	38	1	67,02
14400M-16FR	16	27	38	1	68,28
14400M-17FR	17	28.2	38	1	68,28
14400M-19FR	19	31	38	1	68,28



BUSSOLE "POWER IMPACT" MAGNETICHE

attacco: 1/2"
impronta: ESAGONO

articolo	mm	D mm	L mm	Euro
197-8 M	8	15	38	15,39
197-9 M	9	16,5	38	15,39
197-10 M	10	17,6	38	15,39
197-11 M	11	18,9	38	15,39
197-12 M	12	20,2	38	15,39
197-13 M	13	21,4	38	15,39
197-14 M	14	22,7	38	21,89
197-15 M	15	23,9	38	23,30
197-16 M	16	25	38	24,69
197-17 M	17	26,6	38	24,69
197-18 M	18	27,9	38	26,63
197-19 M	19	29,1	38	27,23
197-21 M	21	32	38	27,23
197-24 M	24	35,4	45	30,22



CHIAVI A BUSSOLA A MACCHINA BOCCA ESAGONALE

articolo	pollici	D mm	L mm	Euro
14400A-1/4	1/4"	12	38	10,67
14400A-5/16	5/16"	14.5	38	10,45
14400A-3/8	3/8"	17	38	10,45
14400A-7/16	7/16"	18.2	38	10,45
14400A-1/2	1/2"	20.7	38	10,45
14400A-9/16	9/16"	22	38	10,45
14400A-19/32	19/32"	23.2	38	11,85
14400A-5/8	5/8"	24.5	38	11,85
14400A-11/16	11/16"	25.7	38	11,85
14400A-3/4	3/4"	28.2	38	11,85
14400A-13/16	13/16"	30.7	38	13,15
14400A-7/8	7/8"	32	38	13,15
14400A-15/16	15/16"	34.5	38	14,38
14400A-1	1"	35.7	38	16,31
14400A-1-1/16	1-1/16"	38.2	40	16,31
14400A-1-1/8	1-1/8"	40.7	42	17,33
14400A-1-3/16	1-3/16"	42	42	19,09
14400A-1-1/4	1-1/4"	44.5	42	21,29
14400A-1-5/16	1-5/16"	45.7	46	31,05
14400A-1-3/8	1-3/8"	47	46	31,68
14400A-1-1/2	1-1/2"	52	46	57,53



CHIAVI A BUSSOLA A MACCHINA BOCCA POLIGONALE

articolo	mm	D mm	L mm	Euro
14405M-8	8	14.5	38	10,20
14405M-9	9	15.7	38	10,20
14405M-10	10	17	38	10,20
14405M-11	11	18.2	38	10,20
14405M-12	12	19.5	38	10,20
14405M-13	13	20.7	38	10,20
14405M-14	14	22	38	10,20
14405M-15	15	23.2	38	11,55
14405M-16	16	24.5	38	11,55
14405M-17	17	25.7	38	11,55
14405M-18	18	27	38	11,55
14405M-19	19	28.2	38	11,55
14405M-20	20	29.5	38	12,82
14405M-21	21	30.7	38	12,82
14405M-22	22	32	38	12,82
14405M-23	23	33.2	38	14,00
14405M-24	24	34.5	38	14,00
14405M-26	26	37	38	15,37
14405M-27	27	38.2	40	15,90
14405M-28	28	39.5	40	16,89
14405M-30	30	42	42	18,59
14405M-32	32	44.5	42	20,74
14405M-36	36	49.5	46	30,88
14405M-41	41	55.7	55	48,70



CHIAVI A BUSSOLA A MACCHINA BOCCA ESAGONALE CON MAGNETE

articolo	mm	D mm	L mm	Euro
14400MG-8	8	14.5	38	16,20
14400MG-10	10	17	38	16,31
14400MG-12	12	19.5	38	16,31
14400MG-13	13	20.7	38	16,31
14400MG-14	14	22	38	22,72
14400MG-15	15	23.2	38	24,39
14400MG-16	16	24.5	38	25,11
14400MG-17	17	25.7	38	25,11
14400MG-18	18	27	38	26,95
14400MG-19	19	28.2	38	27,72
14400MG-21	21	30.7	38	42,79



articolo	DESCRIZIONE	Euro
14245M-05	Set 18 Pezzi in cassetta metallica 395 x 90 x h 50 mm	219,70

RICAMBI		
BUSSOLE POLIGONALE	14405M	10, 12, 13, 14, 16, 17, 18, 19, 21, 22, 24, 27
ACCESSORI	14760-125P	
	14770-P	
	1401A, 1402A	
	1401B, 1402B	

POLLICI



POLIGONALE

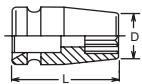

**CHIAVI A BUSSOLA
A MACCHINA
BOCCA POLIGONALE**

Koken articolo	pollici	D mm	L mm		Euro
14406A-1/4	1/4"	10.5	38	1	11,22
14405A-5/16	5/16"	14.5	38	1	10,95
14405A-3/8	3/8"	17	38	1	10,95
14405A-7/16	7/16"	18.2	38	1	10,95
14405A-1/2	1/2"	20.7	38	1	10,95
14405A-9/16	9/16"	22	38	1	10,95
14405A-5/8	5/8"	24.5	38	1	12,43
14405A-11/16	11/16"	25.7	38	1	12,43
14405A-3/4	3/4"	28.2	38	1	12,43
14405A-13/16	13/16"	30.7	38	1	13,78
14405A-7/8	7/8"	32	38	1	13,78
14405A-15/16	15/16"	34.5	38	1	15,07
14405A-1	1"	35.7	38	1	16,58
14405A-1-1/16	1" 1/16	38.2	40	1	17,16
14405A-1-1/8	1" 1/8	40.7	42	1	18,18
14405A-1-3/16	1" 3/16	42	42	1	20,05
14405A-1-1/4	1" 1/4	44.5	42	1	22,30
14405A-1-5/16	1" 5/16	45.7	46	1	32,67
14405A-1-3/8	1" 3/8	47	46	1	33,30
14405A-1-1/2	1" 1/2	52	53	1	62,54

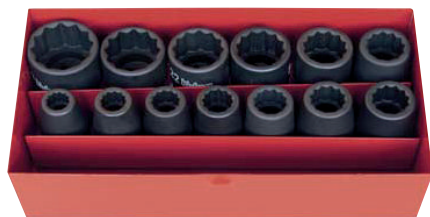

Koken articolo	DESCRIZIONE	Euro
14241M-05	Set chiavi a bussola 13 Pezzi in cassetta metallica 196 x 100 x h 45 mm	162,47
RICAMBI		
14405M	10, 11, 12, 13, 14, 15, 16, 17, 19, 21, 22, 24, 27	

POLIGONALE

PARETI SOTTILI



POLIGONALE

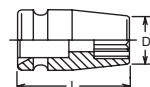

**CHIAVI A BUSSOLA
A MACCHINA
BOCCA POLIGONALE
PARETI SOTTILI**

Koken articolo	mm	D mm	L mm		Euro
14406M-8	8	13	38	1	10,45
14406M-9	9	14.2	38	1	10,45
14406M-10	10	15.5	38	1	10,45
14406M-11	11	16.7	38	1	10,45
14406M-12	12	18	38	1	10,45
14406M-13	13	19.2	38	1	10,15
14406M-14	14	20.5	38	1	10,45
14406M-15	15	21.7	38	1	11,85
14406M-16	16	23	38	1	11,85
14406M-17	17	24.2	38	1	11,85
14406M-18	18	25.5	38	1	11,85
14406M-19	19	26.7	38	1	11,85
14406M-20	20	28	38	1	13,15
14406M-21	21	29.2	38	1	13,15
14406M-22	22	30.5	38	1	13,15
14406M-23	23	31.7	38	1	14,38
14406M-24	24	33	38	1	14,38
14406M-25	25	34.2	38	1	14,38
14406M-26	26	35.5	38	1	15,65
14406M-27	27	36.7	40	1	16,31
14406M-28	28	38	40	1	17,27
14406M-29	29	39.2	42	1	17,27
14406M-30	30	40.5	42	1	19,14
14406M-31	31	41.7	42	1	19,64
14406M-32	32	43	42	1	21,29
14406M-33	33	44.2	46	1	31,05
14406M-34	34	45.5	46	1	31,05
14406M-36	36	48	46	1	31,41



**FAST
LEAD**

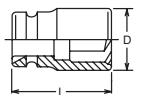

**CHIAVI A BUSSOLA
A MACCHINA
BOCCA FAST LEAD**

Koken articolo	mm	D mm	L mm		Euro
14465M-10	10	17	38	1	13,81
14465M-11	11	18.2	38	1	13,81
14465M-12	12	19.5	38	1	13,81
14465M-13	13	20.7	38	1	13,81
14465M-14	14	22	38	1	13,81
14465M-15	15	23.2	38	1	15,26
14465M-16	16	24.5	38	1	15,26
14465M-17	17	25.7	38	1	15,26
14465M-18	18	27	38	1	15,26
14465M-19	19	28.2	38	1	15,26
14465M-20	20	29.5	38	1	15,07
14465M-21	21	30.7	38	1	15,62
14465M-22	22	32	38	1	16,03
14465M-23	23	33.2	38	1	16,78
14465M-24	24	34.5	38	1	16,78
14465M-26	26	37	38	1	17,46
14465M-27	27	38.2	40	1	18,40



**SURFACE
DRIVE**

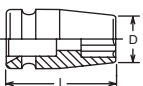

**CHIAVI A BUSSOLA
A MACCHINA
BOCCA SURFACE DRIVE**

Koken articolo	mm	D mm	L mm		Euro
14410M-10	10	17	38	1	10,20
14410M-11	11	18.2	38	1	10,20
14410M-12	12	19.5	38	1	10,20
14410M-13	13	20.7	38	1	10,20
14410M-14	14	22	38	1	10,20
14410M-15	15	23.2	38	1	11,55
14410M-16	16	24.5	38	1	11,55
14410M-17	17	25.7	38	1	11,55
14410M-18	18	27	38	1	11,55
14410M-19	19	28.2	38	1	11,55
14410M-20	20	29.5	38	1	12,82
14410M-21	21	30.7	38	1	12,82
14410M-22	22	32	38	1	12,82
14410M-24	24	34.5	38	1	14,00
14410M-25	25	35.7	38	1	14,00
14410M-26	26	37	38	1	15,37
14410M-27	27	38.2	40	1	15,90
14410M-28	28	39.5	40	1	16,89
14410M-29	29	40.7	42	1	16,89
14410M-30	30	42	42	1	18,59
14410M-31	31	43.2	42	1	19,17
14410M-32	32	44.5	42	1	20,74
14410M-34	34	47	46	1	30,25
14410M-36	36	49.5	46	1	30,88



**CHIAVI A BUSSOLA
A MACCHINA
BOCCA TORX®**



Koken articolo		D mm	L mm		Euro
14425-E10	E 10	14.2	38	1	11,50
14425-E11	E 11	14.2	38	1	11,50
14425-E12	E 12	15.2	38	1	11,50
14425-E14	E 14	18.2	38	1	11,50
14425-E16	E 16	19.2	38	1	11,50
14425-E18	E 18	22.2	38	1	11,50
14425-E20	E 20	24.2	38	1	13,23
14425-E22	E 22	26.2	40	1	18,65
14425-E24	E 24	28.2	40	1	20,68

NEW



**CHIAVI A BUSSOLA TORX FEMMINA
ATTACCO 1/2"**



BGS articolo		L mm		Euro
BGS 9779-10	E 10	38	1	5,10
BGS 9779-12	E 12	38	1	5,10
BGS 9779-14	E 14	38	1	5,10
BGS 9779-16	E 16	38	1	5,10
BGS 9779-18	E 18	38	1	5,36
BGS 9779-20	E 20	38	1	5,36
BGS 9779-22	E 22	40	1	5,61
BGS 9779-24	E 24	40	1	5,87



**CHIAVI A BUSSOLA
A MACCHINA
BOCCA TORX PLUS**

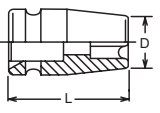

Koken articolo		D mm	L mm		Euro
14425-10EPL	10EPL	14.5	38	1	22,44
14425-12EPL	12EPL	17	38	1	22,44
14425-14EPL	14EPL	18.2	38	1	22,44
14425-16EPL	16EPL	20.7	38	1	22,44
14425-18EPL	18EPL	22	38	1	22,44
14425-20EPL	20EPL	24.5	38	1	23,79



**BUSSOLE IMPACT TORX® FEMMINA
E 10-11-12-14-16-18-20-22-24**

attacco: 1/2"
impronta: TX

Descrizione		Euro
VALIGETTA 9 PEZZI	1	62,63

NEW



**SET 8 PEZZI, BUSSOLE
IMPACT, ATT. 1/2",
TORX FEMMINA,
E10-E24**

DESCRIZIONE	Euro
SET 8 PEZZI, BUSSOLE IMPACT, ATT. 1/2", TORX FEMMINA, E10-E24	36,98

CARATTERISTICHE

- per uso a mano e macchina
- con foro per bloccaggio con spina e anello
- comprende: E10 - E12 - E14 - E16 - E18 - E20 - E22 - E24
- attacco quadro femmina 1/2"
- su guida

TORX PLUS®	S mm	S mm	
E 4	3.70	E 16	14.60
E 5	4.60	E 18	16.50
E 6	5.60	E 20	18.30
E 7	6.10	E 22	20.10
E 8	7.40	E 24	22.00
E 10	9.30	E 26	23.70
E 11	9.90	E 28	25.50
E 12	11.00	E 30	27.30
E 14	12.80	E 32	29.00



**QUADRE FEMMINA
attacco: 1/2"
impronta: QUADRA**

articolo		L mm		Euro
197- 7 VKT	7	40	1	14,05
197- 8 VKT	8	40	1	14,05
197-10 VKT	10	40	1	14,05
197-11 VKT	11	40	1	14,05
197-12 VKT	12	40	1	14,05
197-13 VKT	13	40	1	14,05
197-14 VKT	14	40	1	14,05
197-15 VKT	15	40	1	14,05
197-16 VKT	16	40	1	14,60
197-17 VKT	17	40	1	19,43
197-18 VKT	18	38	1	19,43
197-19 VKT	19	40	1	19,43
197-21 VKT	21	40	1	30,18
197-22 VKT	22	40	1	30,18
197-24 VKT	24	40	1	31,40
197-27 VKT	27	46	1	31,40
197-30 VKT	30	50	1	36,75
197-32 VKT	32	50	1	39,90
197-36 VKT	36	55	1	40,95



QUADRO

NEW

CHIAVI A BUSSOLA
A MACCHINA
BOCCA QUADRA

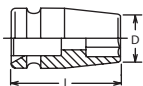

Koken articolo	mm	D mm	L mm		Euro
14400WN-8	8	18.3	38	1	36,63
14400WN-9	9	19.5	38	1	36,63
14400WN-10	10	20.8	38	1	36,63
14400WN-12	12	24.5	38	1	38,47
14400WN-14	14	27	38	1	38,47
14400WN-17	17	32	40	1	39,99



**OTTAGONALE
OTTO ANGOLI**

CHIAVI A BUSSOLA
A MACCHINA
BOCCA OTTAGONALE

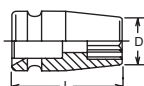

Koken articolo	mm	D mm	L mm		Euro
14415M-14	14	25.7	38	1	16,25
14415M-15	15	27	38	1	16,25
14415M-16	16	29.5	38	1	16,47
14415M-17	17	30.7	38	1	16,47
14415M-18	18	32	38	1	17,35
14415M-19	19	33.2	38	1	17,35
14415M-22	22	38.2	40	1	19,75
14415M-24	24	42	42	1	22,58
14415M-27	27	45.7	46	1	36,58
14415M-28	28	47	46	1	37,37
14415M-29	29	49.5	46	1	37,95



BGS articolo	DESCRIZIONE	Euro
BGS 2560	SET 10 PEZZI, BUSSOLE SPECIALI PER AUTOMOTIVE DA 3-5-6-10 LATI	80,33

CARATTERISTICHE

- contenuto:
 - M10S, per vite centrale tendicinghia
 - M6S, per frizione Nissan e Renault
 - M8S, per testa cilindri e contralbero Nissan
 - M12S, per testa cilindri Nissan
 - 8TS, per contralbero Nissan
 - 10 mm, per impianti di frenatura
 - 12 mm, per pompa del combustibile Nissan
 - 14 mm, per GM e Smart
 - 19 mm, per freno di stazionamento Peugeot, Renault e Citroen
 - 20 mm, per braccio trasversale inferiore Honda Civic
- lunghezza: 38 mm

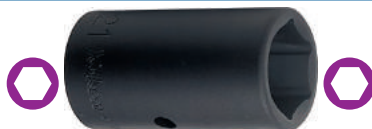

CHIAVI A BUSSOLA
A MACCHINA
DOPPIO ESAGONO

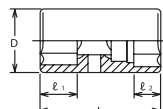

Koken articolo	mm	D mm	L mm		Euro
14118M-17X19	17x19	28	48	1	21,70
14118M-19X21	19x21	31	57	1	21,70
14118M-19X22	19x22	31	57	1	22,74

**PARETI SOTTILI
SU TUTTO IL CORPO**



**SURFACE
DRIVE**

CHIAVI A BUSSOLA
POWER
BOCCA SURFACE DRIVE

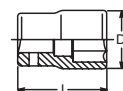

Koken articolo	mm	D mm	L mm		Euro
24410M-10	10	15.3	37	1	7,84
24410M-12	12	17.8	37	1	7,84
24410M-13	13	19	37	1	7,84
24410M-14	14	20.3	37	1	8,20
24410M-15	15	21.5	37	1	8,42
24410M-16	16	22.8	37	1	8,42
24410M-17	17	24.1	37	1	8,42
24410M-18	18	25.1	37	1	8,80
24410M-19	19	26.6	38	1	8,80
24410M-21	21	29.1	30	1	10,92
24410M-22	22	30.1	40	1	11,41
24410M-24	24	32.9	42	1	11,41

**PARETI SOTTILI
SU TUTTO IL CORPO**



TORX®

CHIAVI A BUSSOLA
POWER
BOCCA TORX®

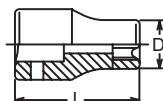

Koken articolo		D mm	L mm		Euro
24425-E10	E 10	14.2	38	1	8,64
24425-E12	E 12	15.2	38	1	8,64
24425-E14	E 14	18.2	38	1	8,64
24425-E16	E 16	19.2	38	1	8,80
24425-E18	E 18	22.2	38	1	8,80
24425-E20	E 20	24.2	38	1	9,46

CARATTERISTICHE

- misure: M6S, M8S, M12S
- finitura fosfata nera
- bussole speciali per: Nissan, Renault, giunti, testate, ecc...
- attacco quadro: 1/2"



1/2"

ESAGONO

LUNGHE

attacco: 1/2"
impronta: ESAGONO

articolo	D mm	L mm	Euro
197-8 L	8	78	13,23
197-10 L	10	78	13,23
197-11 L	11	78	13,23
197-12 L	12	78	13,23
197-13 L	13	78	13,23
197-14 L	14	78	13,80
197-15 L	15	78	13,80
197-16 L	16	78	13,80
197-17 L	17	78	13,80
197-18 L	18	78	14,37
197-19 L	19	78	14,37
197-20 L	20	78	14,37
197-21 L	21	78	15,52
197-22 L	22	78	15,52
197-23 L	23	78	16,10
197-24 L	24	78	16,10
197-25 L	25	78	18,91
197-26 L	26	78	20,79
197-27 L	27	78	20,79
197-28 L	28	78	23,82
197-29 L	29	78	25,78
197-30 L	30	78	25,87
197-32 L	32	78	29,93
197-33 L	33	78	35,18
197-34 L	34	78	35,18
197-36 L	36	78	46,66
197-38 L	38	78	46,66



1/2"

PRO+ CROMO

ESAGONO

LUNGHE ECONOMICHE

attacco: 1/2"
impronta: ESAGONO

articolo	D mm	L mm	Euro
BGS 7248	8	78	7,40
BGS 7210	10	78	7,65
BGS 7211	11	78	7,65
BGS 7212	12	78	7,65
BGS 7213	13	78	7,65
BGS 7214	14	78	7,65
BGS 7215	15	78	7,65
BGS 7216	16	78	7,65
BGS 7217	17	78	7,91
BGS 7218	18	78	8,42
BGS 7219	19	78	8,67
BGS 7221	21	78	9,44
BGS 7222	22	78	9,69
BGS 7224	24	78	10,20
BGS 7227	27	78	13,52
BGS 7230	30	78	14,79
BGS 7232	32	78	15,81
BGS 7236	36	78	20,66

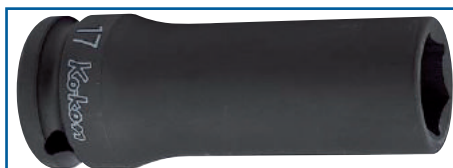

ESAGONO

CHIAVI A BUSSOLA
A MACCHINA
BOCCA ESAGONALE
TIPO LUNGO

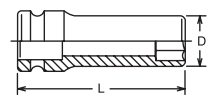

articolo	D mm	L mm	Euro
14300M-8	8	80	18,04
14300M-9	9	80	18,04
14300M-10	10	80	18,04
14300M-11	11	80	18,04
14300M-12	12	80	18,04
14300M-13	13	80	18,04
14300M-14	14	80	18,04
14300M-15	15	80	19,03
14300M-16	16	80	19,03
14300M-17	17	80	19,03
14300M-18	18	80	19,03
14300M-19	19	80	19,03
14300M-20	20	80	19,44
14300M-21	21	80	20,21
14300M-22	22	85	20,79
14300M-23	23	85	22,58
14300M-24	24	85	22,58
14300M-25	25	85	23,07
14300M-26	26	85	25,60
14300M-27	27	85	26,29
14300M-28	28	85	29,15
14300M-29	29	85	31,30
14300M-30	30	85	31,30
14300M-31	31	85	33,50
14300M-32	32	85	33,50
14300M-33	33	85	41,69
14300M-34	34	85	41,69
14300M-35	35	85	42,90
14300M-36	36	85	53,38
14300M-38	38	85	54,92
14300M-41	41	85	66,41



articolo	DESCRIZIONE	Euro
14208M	Set 13 Pezzi in cassetta metallica 395 x 90 x h 50 mm	267,14
RICAMBI		
BUSSOLE ESAGONO	14300M	10, 12, 13, 14, 15, 16, 17, 18, 19, 21, 22, 24, 27 MM



articolo	DESCRIZIONE	Euro
14207M	Set 10 Pezzi in cassetta metallica 310 x 90 x h 48 mm	210,57
RICAMBI		
BUSSOLE ESAGONO	14300M	10, 12, 13, 14, 17, 19, 21, 22, 24, 27



CHIAVI A BUSSOLA
CON ESAGONO
INTERNO PROFONDO
BOCCA ESAGONALE

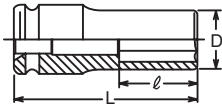

Koken articolo	mm	D mm	mm	L mm	Euro
14113M-17	17	25.7	34	80	20,54
14113M-19	19	28.2	38	80	20,54
14113M-21	21	30.7	42	80	24,04

PARETI SOTTILI



CHIAVI A BUSSOLA
A MACCHINA
BOCCA ESAGONALE
TIPO LUNGO
PARETI SOTTILI

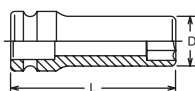

Koken articolo	mm	D mm	L mm	Euro
14301M-8	8	13	80	18,04
14301M-9	9	14.2	80	18,04
14301M-10	10	15.5	80	18,04
14301M-11	11	16.7	80	18,04
14301M-12	12	18	80	18,04
14301M-13	13	19.2	80	18,04
14301M-14	14	20.5	80	18,04
14301M-15	15	21.7	80	19,03
14301M-16	16	23	80	19,03
14301M-17	17	24.2	80	19,03
14301M-18	18	25.5	80	19,03
14301M-19	19	26.7	80	19,03
14301M-20	20	28	80	19,44
14301M-21	21	29.2	80	20,21
14301M-22	22	30.5	85	20,79
14301M-23	23	31.7	85	22,58
14301M-24	24	33	85	22,58
14301M-25	25	34.2	85	23,07
14301M-26	26	35.5	85	25,60
14301M-27	27	36.7	85	26,29
14301M-28	28	36.7	85	29,15
14301M-29	29	38	85	31,30
14301M-30	30	39.2	85	31,30
14301M-31	31	41.7	85	33,50
14301M-32	32	43	85	33,50
14301M-34	34	45.5	85	41,69
14301M-35	35	46.7	85	42,90
14301M-36	36	48	85	53,38
14301M-38	38	50.5	85	54,92
14301M-41	41	54.2	85	66,41



magnete
extra forte



CHIAVI A BUSSOLA
A MACCHINA
BOCCA ESAGONALE
TIPO LUNGO
MAGNETE RETRATTILE

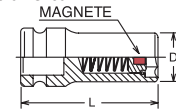

Koken articolo	mm	D mm	L mm	Euro
14300G-10	10	17	80	31,52
14300G-12	12	19.5	80	31,52
14300G-13	13	20.7	80	32,86
14300G-14	14	22	80	32,86
14300G-15	15	23.2	80	36,11
14300G-16	16	24.5	80	36,11
14300G-17	17	25.7	80	36,11
14300G-18	18	27	80	42,90
14300G-19	19	28.2	80	44,11

PARETI SOTTILI



SEMI-LUNGA



CHIAVI A BUSSOLA
A MACCHINA
BOCCA ESAGONALE
TIPO SEMI-LUNGO
PARETI SOTTILI

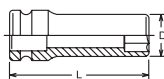

Koken articolo	mm	D mm	L mm	Euro
14301X-8	8	13	60	16,75
14301X-9	9	14.2	60	16,75
14301X-10	10	15.5	60	16,75
14301X-11	11	16.7	60	16,75
14301X-12	12	18	60	16,75
14301X-13	13	19.2	60	16,75
14301X-14	14	20.5	60	16,75
14301X-15	15	21.7	60	18,21
14301X-16	16	23	60	18,21
14301X-17	17	24.2	60	18,21
14301X-18	18	25.5	60	18,37
14301X-19	19	26.7	60	18,37
14301X-21	21	29.2	60	19,39
14301X-22	22	30.5	65	19,75
14301X-23	23	31.7	65	21,20
14301X-24	24	33	65	21,53
14301X-25	25	34.2	65	21,53
14301X-26	26	35.5	65	23,79
14301X-27	27	36.7	65	24,92
14301X-30	30	40.5	65	29,89
14301X-32	32	43	65	32,97
14301X-33	33	44.2	65	46,28
14301X-34	34	45.5	65	46,28
14301X-36	36	48	65	48,76



BGS articolo	DESCRIZIONE	Euro
BGS 95207	SET 13 PEZZI BUSSOLE A MACCHINA TIPO LUNGO, ATT. 1/2"	87,10

CARATTERISTICHE

- per uso con avvitatori pneumatici
- esagonali
- tipo lungo
- misure:
10-13-14-15-17-18-19-21-22-24-27-30-32 mm
- coppia massima:
10 mm - 153 Nm, 13 mm - 249 Nm,
14 mm - 282 Nm, 15 mm - 339 Nm,
17 mm - 475 Nm, 18 mm - 542 Nm,
19 mm - 565 Nm, 21 mm - 570 Nm,
22 mm - 570 Nm, 24 mm - 570 Nm,
27 mm - 570 Nm, 30 mm - 570 Nm,
32 mm - 570 Nm
- lunghezza totale: 78 mm (profondità utile interna circa 40 mm)



1/2" ESAGONO CRO MO PRO+

BGS articolo	DESCRIZIONE	Euro
BGS 5206	SET 10 PEZZI, BUSSOLE A MACCHINA TIPO LUNGO	72,68

CARATTERISTICHE

- in cromo molibdeno
- con scanalatura e foro per spina
- misure: 10-12-13-14-15-17-19-21-22-24 mm



1/2" POLIGONALE CRO MO PRO+

BGS articolo	DESCRIZIONE	Euro
BGS 5334	SET 6 PEZZI BUSSOLE PER ALBERO MOTORE E MOZZI RUOTE	84,66

CARATTERISTICHE

- bussole poligonali: 30 - 32 - 36 mm
- bussole esagono maschio: 14 - 17 - 19 mm



1/2" POLIGONALE CRO MO PRO+

BGS articolo	DESCRIZIONE	Euro
BGS 5335	SET 8 PEZZI, BUSSOLE PER ALBERO MOTORE E MOZZI RUOTE	110,93

CARATTERISTICHE

- bussole poligonali: 27 - 30 - 32 - 34 - 36 mm
- bussole esagono maschio: 14 - 17 - 19 mm



1/2" ESAGONO CRO MO PRO

BGS articolo	DESCRIZIONE	Euro
BGS 5207	SET 14 PEZZI, BUSSOLE A MACCHINA TIPO LUNGO	121,13

CARATTERISTICHE

- in cromo molibdeno
- 10-12-13-14-15-17-18-19-21-22-24-27-30-32 mm
- lunghezza 75 mm

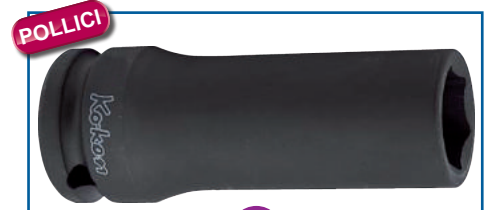

ESAGONO

CHIAVI A BUSSOLA A MACCHINA BOCCA ESAGONALE TIPO LUNGO

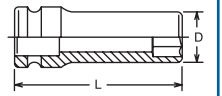

Koken articolo	pollici	D mm	L mm	Euro
14300A-5/16	5/16"	14.5	80	19,42
14300A-3/8	3/8"	17	80	19,42
14300A-7/16	7/16"	18.2	80	19,42
14300A-1/2	1/2"	20.7	80	19,42
14300A-9/16	9/16"	22	80	19,42
14300A-5/8	5/8"	24.5	80	20,49
14300A-11/16	11/16"	25.7	80	20,49
14300A-3/4	3/4"	28.2	80	20,49
14300A-13/16	13/16"	30.7	80	21,81
14300A-7/8	7/8"	32	85	22,41
14300A-15/16	15/16"	34.5	85	24,34
14300A-1	1"	35.7	85	27,61
14300A-1-1/16	1-1/16"	38.2	85	28,27
14300A-1-1/8	1-1/8"	40.7	85	33,74
14300A-1-3/16	1-3/16"	42	85	33,74
14300A-1-1/4	1-1/4"	44.5	85	36,14
14300A-1-7/16	1-7/16"	50.7	85	59,21
14300A-1-1/2	1-1/2"	52	85	59,21



1/2" ESAGONO CRO MO PRO+

BGS articolo	DESCRIZIONE	Euro
BGS 5208	SET 13 PEZZI, BUSSOLE A MACCHINA TIPO LUNGO, IN POLLICI, 7/16" - 1 1/4"	108,38

CARATTERISTICHE

- lunghezza: 75 mm
- fosfatate
- con scanalatura e foro per spina
- misure: 7/16" - 1/2" - 9/16" - 5/8" - 11/16" - 3/4" - 13/16" - 7/8" - 15/16" - 1" - 1 1/16" - 1 1/8" - 1 1/4"

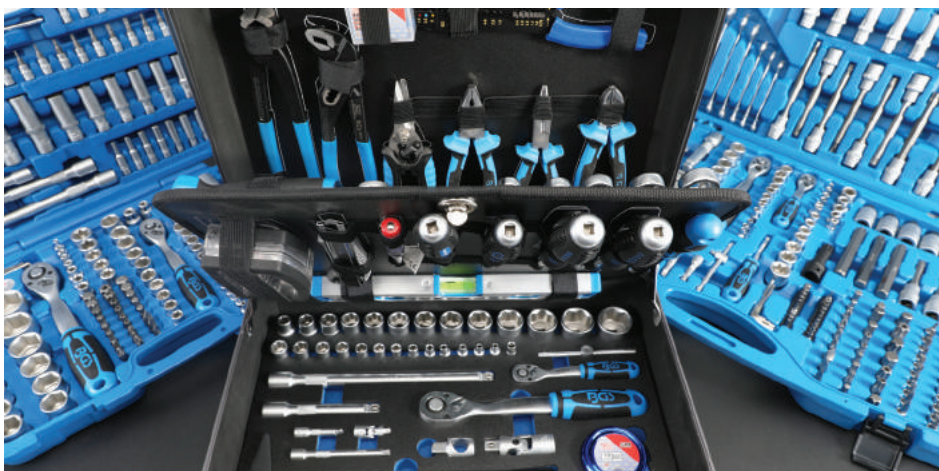

IMPACT 1/2"



CHIAVI A BUSSOLA
A MACCHINA
BOCCA POLIGONALE
TIPO LUNGO

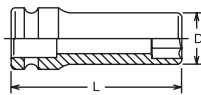

Koken articolo	mm	D mm	L mm	Euro
14305M-8	8	14.5	80	18,92
14305M-10	10	17	80	18,92
14305M-11	11	18.2	80	18,92
14305M-12	12	19.5	80	18,92
14305M-13	13	20.7	80	18,92
14305M-14	14	22	80	18,92
14305M-15	15	23.2	80	19,97
14305M-16	16	24.5	80	19,97
14305M-17	17	25.7	80	19,97
14305M-18	18	27	80	19,97
14305M-19	19	28.2	80	19,97
14305M-20	20	29.5	80	20,43
14305M-21	21	30.7	80	21,26
14305M-22	22	32	85	21,84
14305M-23	23	33.2	85	23,73
14305M-24	24	34.5	85	23,73
14305M-26	26	37	85	26,92
14305M-27	27	38.2	85	27,53
14305M-28	28	39.5	85	30,61
14305M-29	29	40.7	85	32,86
14305M-30	30	42	85	32,86
14305M-32	32	44.5	85	35,23
14305M-33	33	45.7	85	43,75
14305M-36	36	49.5	85	56,05



POLIGONALI LUNGHE ECONOMICHE

attacco: 1/2"
impronta: POLIGONALE

BGS articolo	mm	L mm	Euro
BGS 5353	21	85	10,71
BGS 5343	24	85	12,75
BGS 5352	28	85	14,28
BGS 5336	27	85	14,28
BGS 5337	30	85	16,58
BGS 5338	32	85	17,47
BGS 5339	33	85	19,64
BGS 5340	34	85	19,89
BGS 5341	35	85	21,17
BGS 5342	36	85	22,06
BGS 5344	38	85	23,46
BGS 5351	39	85	30,47
BGS 5234	46	85	42,08

PARETI SOTTILI



CHIAVI A BUSSOLA
A MACCHINA
BOCCA POLIGONALE
TIPO LUNGO
PARETI SOTTILI

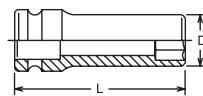

Koken articolo	mm	D mm	L mm	Euro
14306M-8	8	13	80	19,42
14306M-10	10	15.5	80	19,42
14306M-12	12	18	80	19,42
14306M-13	13	19.2	80	19,42
14306M-14	14	20.5	80	19,42
14306M-15	15	21.7	80	20,49
14306M-16	16	23	80	20,49
14306M-17	17	24.2	80	20,49
14306M-18	18	25.5	80	20,49
14306M-19	19	26.7	80	20,49
14306M-21	21	29.2	80	21,81
14306M-22	22	30.5	85	22,41
14306M-24	24	33	85	24,34
14306M-27	27	36.7	85	28,27
14306M-30	30	40.5	85	33,74
14306M-32	32	43	85	36,14



CHIAVI A BUSSOLA
A MACCHINA
BOCCA SURFACE
DRIVE

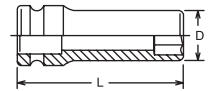

TIPO LUNGO

Koken articolo	mm	D mm	L mm	Euro
14310M-10	10	17	80	18,92
14310M-11	11	18.2	80	18,92
14310M-12	12	19.5	80	18,92
14310M-13	13	20.7	80	18,92
14310M-14	14	22	80	18,92
14310M-15	15	23.2	80	19,97
14310M-16	16	24.5	80	19,97
14310M-17	17	25.7	80	19,97
14310M-18	18	27	80	19,97
14310M-19	19	28.2	80	19,97
14310M-20	20	29.5	80	20,43
14310M-21	21	30.7	80	21,26
14310M-22	22	32	85	21,84
14310M-23	23	33.2	85	23,73
14310M-24	24	34.5	85	23,73
14310M-25	25	35.7	85	24,23
14310M-26	26	37	85	26,92
14310M-27	27	38.2	85	27,53
14310M-28	28	39.5	85	30,61
14310M-29	29	40.7	85	32,86
14310M-30	30	42	85	32,86
14310M-31	31	43.2	85	35,23
14310M-32	32	44.5	85	35,23
14310M-34	34	47	85	43,75
14310M-36	36	49.5	85	56,05



**MULTIMPRONTA
SPLINE DRIVE** **PRO+** **CROMO** 1/2"

BGS articolo	DESCRIZIONE	Euro
BGS 5209	SET 14 PEZZI, BUSSOLE IMPACT MULTIMPRONTA, LUNGHE, ATT. 1/2", 10-32 MM	128,75

CARATTERISTICHE

- comprende le seguenti misure: 10 - 12 - 13 - 14 - 15 - 17 - 18 - 19 - 21 - 22 - 24 - 27 - 30 - 32 mm
- adatte per dadi esagonali, poligonali, metriche ed in pollici, TORX®



**CHIAVI A BUSSOLA
A MACCHINA
BOCCA FAST LEAD
TIPO LUNGO**

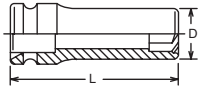

Koken articolo	mm	D mm	L mm	Euro
14365M-10	10	17	80	22,22
14365M-11	11	18.2	80	22,22
14365M-12	12	19.5	80	22,22
14365M-13	13	20.7	80	22,22
14365M-14	14	22	80	22,22
14365M-15	15	23.2	80	23,05
14365M-16	16	24.5	80	23,05
14365M-17	17	25.7	80	23,05
14365M-18	18	27	80	24,92
14365M-19	19	28.2	80	24,92
14365M-20	20	29.5	80	24,92
14365M-21	21	30	80	25,91
14365M-22	22	32	85	25,91
14365M-23	23	33.2	85	28,11
14365M-24	24	34.5	85	28,11
14365M-26	26	37	85	29,01
14365M-27	27	38.2	85	30,88



NEW



BGS articolo	DESCRIZIONE	Euro
BGS 5204	SET 10 PEZZI BUSSOLE A MACCHINA TORX TIPO LUNGO	69,62

CARATTERISTICHE

- per uso con avvitatori pneumatici
- in acciaio al cromo-molibdeno
- misure: E10, E11, E12, E14, E16, E18, E20, E22, E24
- con scanalatura e foro per spina



**BUSSOLA A MACCHINA LUNGA
ATTACCO 1/2" TORX - ECONOMICHE**

BGS articolo	TORX	L mm	Euro
BGS 5204-10	E 10	78	6,89
BGS 5204-11	E 11	78	6,89
BGS 5204-12	E 12	78	6,89
BGS 5204-14	E 14	78	7,14
BGS 5204-16	E 16	78	7,14
BGS 5204-18	E 18	78	7,40
BGS 5204-20	E 20	78	7,65
BGS 5204-22	E 22	78	8,42
BGS 5204-24	E 24	78	9,18

CARATTERISTICHE

- con scanalatura e foro per spina



**CHIAVI A BUSSOLA
A MACCHINA
BOCCA TORX®
TIPO LUNGO**

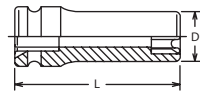

Koken articolo	TORX	D mm	L mm	Euro
14325-E10	E 10	14.2	80	21,31
14325-E12	E 12	15.2	80	21,31
14325-E14	E 14	18.2	80	21,01
14325-E16	E 16	19.2	80	21,31
14325-E18	E 18	22.2	80	21,31
14325-E20	E 20	24.2	80	23,16

TORX®	S mm	S mm	
E 4	3.70	E 16	14.60
E 5	4.60	E 18	16.50
E 6	5.60	E 20	18.30
E 7	6.10	E 22	20.10
E 8	7.40	E 24	22.00
E 10	9.30	E 26	23.70
E 11	9.90	E 28	25.50
E 12	11.00	E 30	27.30
E 14	12.80	E 32	29.00



**PARETI SOTTILI
SU TUTTO IL CORPO**



**CHIAVI A BUSSOLA
POWER
BOCCA ESAGONALE
TIPO LUNGO**

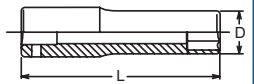

Koken articolo	mm	D mm	L mm	Euro
24300M-10	10	15.3	77	15,07
24300M-11	11	16.5	77	15,07
24300M-12	12	17.8	77	15,07
24300M-13	13	19	77	15,07
24300M-14	14	20.3	77	15,07
24300M-15	15	21.5	77	15,07
24300M-16	16	22.8	77	15,07
24300M-17	17	24	77	15,07
24300M-18	18	25	77	16,36
24300M-19	19	26.5	77	16,36
24300M-20	20	27.8	77	17,19
24300M-21	21	29	77	19,03
24300M-22	22	30	77	19,61
24300M-24	24	32.8	77	21,37
24300M-27	27	36.5	77	25,60
24300M-30	30	40	77	30,44
24300M-32	32	42.8	77	32,78

POLLICI



**PARETI SOTTILI
SU TUTTO IL CORPO**



**CHIAVI A BUSSOLA
POWER BOCCA
ESAGONALE TIPO LUNGO**

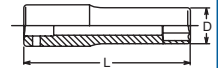

Koken articolo	pollici	D mm	L mm	Euro
24300A-7/16	7/16"	16.5	77	16,23
24300A-1/2	1/2"	19	77	16,23
24300A-9/16	9/16"	20.3	77	16,23
24300A-5/8	5/8"	22.8	77	16,23
24300A-21/32	21/32"	24	77	16,23
24300A-11/16	11/16"	25	77	17,63
24300A-3/4	3/4"	26.5	77	17,63
24300A-13/16	13/16"	29	77	20,54
24300A-15/16	15/16"	32.8	77	23,05



PARETI SOTTILI
SU TUTTO IL CORPO

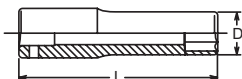

SURFACE
DRIVE

CHIAVI A BUSSOLA
POWER
BOCCA SURFACE
DRIVE TIPO LUNGO





Koken articolo	 mm	D mm	L mm		Euro
24310M-10	10	15.3	77	1	15,81
24310M-12	12	17.8	77	1	15,81
24310M-13	13	19	77	1	15,81
24310M-14	14	20.3	77	1	15,81
24310M-15	15	21.5	77	1	15,81
24310M-16	16	22.8	77	1	15,81
24310M-17	17	24.1	77	1	15,81
24310M-18	18	25	77	1	17,19
24310M-19	19	26.5	77	1	17,19
24310M-21	21	29	77	1	19,99
24310M-22	22	30	77	1	20,60
24310M-24	24	32.8	77	1	22,44



CHIAVI A
BUSSOLA
A MACCHINA
BOCCA
ESAGONALE
TIPO EXTRA
LUNGO

ESAGONO



Koken articolo	 mm	D mm	L mm		Euro
NEW 14145M-100-10	10	17	100	1	30,20
NEW 14145M-100-12	12	19.5	100	1	30,20
NEW 14145M-100-14	14	22	100	1	30,20
NEW 14145M-100-17	17	25.7	100	1	33,22
NEW 14145M-100-19	19	28.2	100	1	33,22
14145M-150-10	10	17	150	1	33,22
14145M-150-12	12	19.5	150	1	33,22
14145M-150-13	13	20.7	150	1	33,22
14145M-150-14	14	22	150	1	33,22
14145M-150-15	15	23.2	150	1	34,60
14145M-150-16	16	24.5	150	1	34,60
14145M-150-17	17	25.7	150	1	34,60
14145M-150-18	18	27	150	1	34,60
14145M-150-19	19	28.2	150	1	34,60
14145M-200-10	10	17	200	1	36,85
14145M-200-12	12	19.5	200	1	36,85
14145M-200-13	13	20.7	200	1	36,85
14145M-200-14	14	22	200	1	36,85
14145M-200-15	15	23.2	200	1	38,25
14145M-200-16	16	24.5	200	1	38,25
14145M-200-17	17	25.7	200	1	38,25
14145M-200-18	18	27	200	1	38,25
14145M-200-19	19	28.2	200	1	38,25
14145M-250-10	10	17	250	1	38,45
14145M-250-12	12	19.5	250	1	38,45
14145M-250-13	13	20.7	250	1	38,45
14145M-250-14	14	22	250	1	38,45
14145M-250-15	15	23.2	250	1	39,82
14145M-250-16	16	24.5	250	1	39,82
14145M-250-17	17	25.7	250	1	39,82
14145M-250-18	18	27	250	1	39,82
14145M-250-19	19	28.2	250	1	39,82
POLLICI					
14145A-150-9/16	9/16	20	150	1	38,56



1/2"

ESAGONO

 CRO
MO

 PRO+

BGS
articolo

DESCRIZIONE

Euro

BGS 5200

SET 4 PEZZI, BUSSOLE
SNODATE
A MACCHINA

77,78

CARATTERISTICHE

- per utilizzo a macchina
- misure: 16, 17, 18, 19 mm
- attacco quadro da 1/2"
- lunghezza 65 mm
- con scanalatura e foro per spina

RICAMBI



BGS articolo	DESCRIZIONE	Euro
BGS 5200-16	16 MM	15,30
BGS 5200-17	17 MM	15,81
BGS 5200-18	18 MM	16,58
BGS 5200-19	19 MM	17,34

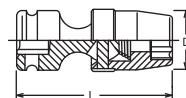

ESAGONO

CHIAVI A BUSSOLA
A MACCHINA
SNODATE
BOCCA ESAGONALE



Koken articolo	 mm	D mm	L mm		Euro
14440M-13	13	20.7	67.5	1	47,85
14440M-14	14	22	69.5	1	47,85
14440M-15	15	23.2	69.5	1	47,85
14440M-16	16	24.5	69.5	1	47,85
14440M-17	17	25.7	69.5	1	47,85
14440M-18	18	27	69.5	1	47,85
14440M-19	19	28.2	73.5	1	47,85
14440M-20	20	29.5	73.5	1	47,85
14440M-21	21	30.7	73.5	1	47,85
14440M-22	22	32	73.5	1	48,92
14440M-24	24	34.5	75.5	1	50,33

POLLICI

14440A-1/2	1/2"	20.7	67.5	1	51,62
14440A-9/16	9/16"	22	69.5	1	51,62
14440A-5/8	5/8"	24.5	69.5	1	51,62
14440A-11/16	11/16"	25.7	69.5	1	51,62
14440A-3/4	3/4"	28.2	73.5	1	51,62





CHIAVI A
BUSSOLA
A MACCHINA
BOCCA
ESAGONALE
TIPO EXTRA
LUNGO SNODATA

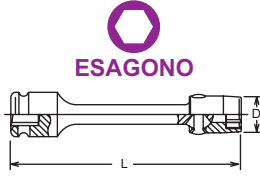

Koken articolo	mm	D mm	L mm	€uro
14146M-150-10	10	16	150	66,58
14146M-150-12	12	19.3	150	66,58
14146M-150-13	13	20	150	66,58
14146M-150-14	14	21	150	66,58
14146M-150-15	15	22	150	66,58
14146M-150-16	16	23	150	66,58
14146M-150-17	17	25	150	66,58
14146M-150-18	18	28	150	66,58
14146M-150-19	19	26	150	66,58
14146M-200-10	10	16	200	69,27
14146M-200-12	12	19.3	200	69,27
14146M-200-13	13	20	200	69,27
14146M-200-14	14	21	200	69,27
14146M-200-15	15	22	200	69,27
14146M-200-16	16	23	200	69,27
14146M-200-17	17	25	200	69,27
14146M-200-18	18	28	200	69,27
14146M-200-19	19	26	200	69,27
14146M-250-10	10	16	250	72,27
14146M-250-12	12	19.3	250	72,27
14146M-250-13	13	20	250	72,27
14146M-250-14	14	21	250	72,27
14146M-250-15	15	22	250	72,27
14146M-250-16	16	23	250	72,27
14146M-250-17	17	25	250	72,27
14146M-250-18	18	28	250	72,27
14146M-250-19	19	26	250	72,27



1/2"



QUADRO

BUSSOLE CON QUADRO MASCHIO

attacco: 1/2"
impronta: QUADRO MASCHIO

FEFMEC articolo	mm	L mm	€uro
4110 M- 6	6	35	10,86
4110 M- 7	7	35	10,86
4110 M- 8	8	32	10,86
4110 M- 10	10	32	10,86
4110 M- 10,5	10,5	32	10,86
4110 M- 12	12	32	10,86
4110 M- 13	13	32	10,86
4110 M- 13,5	13,5	32	10,86
4110 M- 14	14	35	10,86
4110 M- 15	15	35	10,86
4110 M- 16	16	35	10,86
4110 M- 19	19	32	12,68
4110 M- 20	20	32	12,68

POLLICI



QUADRO

**CHIAVI A BUSSOLA
MASCHIO QUADRO**

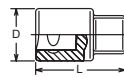

Koken articolo	D mm	L mm	€uro
4110A-3/8	3/8"	24	11,69
4110A-1/2	1/2"	24	11,69



1/2"

ESAGONO

**SERIE BUSSOLE IMPACT BRUGOLA
MM 4-5-6-8-10-12-14-17-19
LUNGH. 75 MM**

attacco: 1/2"
impronta: ESAGONO MASCHIO

FEFMEC articolo	Descrizione	€uro
521093	CASSETTA METALLICA 9 PEZZI	75,60



1/2"



ESAGONO



**BUSSOLE ESAGONALI MASCHIO INTEGRALI
CON FORO NEL QUADRO PER SPINA ED
ANELLO**

attacco: 1/2"
impronta: BRUGOLA ESAGONO

FEFMEC articolo	mm	L mm	€uro
BGS 5485-5	5	42	11,50
BGS 5485-6	6	42	11,50
BGS 5485-7	7	42	11,50
BGS 5485-8	8	42	11,50
BGS 5485-9	9	42	11,50
BGS 5485-10	10	42	11,50
BGS 5485-11	11	42	11,50
BGS 5485-12	12	42	11,50
BGS 5485-13	13	42	11,50
BGS 5485-14	14	42	11,50

182 - 1/2" - 4	4	55	15,75
182 - 1/2" - 5	5	55	15,75
182 - 1/2" - 6	6	55	15,75
182 - 1/2" - 7	7	55	15,75
182 - 1/2" - 8	8	55	15,75
182 - 1/2" - 10	10	55	15,75
182 - 1/2" - 12	12	40	15,75
182 - 1/2" - 13	13	40	15,75
182 - 1/2" - 14	14	40	15,75
182 - 1/2" - 16	16	40	15,75
182 - 1/2" - 17	17	45	15,75
182 - 1/2" - 19	19	50	15,75

826004	4	75	15,75
826005	5	75	15,75
826006	6	75	15,75
826008	8	75	15,75
826010	10	75	15,75
826012	12	75	15,75
826014	14	75	15,75
826017	17	75	15,75
826019	19	75	15,75

1182 - 1/2" - 5	5	100	26,25
1182 - 1/2" - 6	6	100	26,25
1182 - 1/2" - 8	8	100	26,25
1182 - 1/2" - 10	10	100	26,25
1182 - 1/2" - 12	12	100	26,25
1182 - 1/2" - 14	14	100	26,25

3182 - 1/2" - 5	5	150	29,40
3182 - 1/2" - 6	6	150	29,40
3182 - 1/2" - 8	8	150	29,40
3182 - 1/2" - 10	10	150	29,40
3182 - 1/2" - 12	12	150	29,40
3182 - 1/2" - 14	14	150	29,40





ESAGONO

CHIAVI A BUSSOLA
A MACCHINA
MASCHIO
ESAGONALE
INTEGRALE

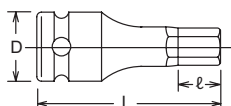

Kokon articolo	mm	D mm	l mm	L mm	Euro
14012M-60-4	4	25	15.5	60	20,21
14012M-60-5	5	25	15.5	60	20,21
14012M-60-6	6	25	15.5	60	20,21
14012M-60-7	7	25	15.5	60	20,21
14012M-60-8	8	25	15.5	60	20,21
14012M-60-10	10	30	15.5	60	20,21
14012M-60-12	12	30	15.5	60	20,21
14012M-60-14	14	30	15.5	60	21,26
14012M-60-16	16	30	15.5	60	21,26
14012M-60-17	17	30	15.5	60	21,26
14012M-60-19	19	30	15.5	60	24,04



ESAGONO

SERIE 10 PZ. CHIAVI A BUSSOLA A MACCHINA
MASCHIO ESAGONALE

Kokon articolo	mm	Euro
RS14012M/10-L60	4, 5, 6, 7, 8, 10, 12, 14, 17, 19	203,36

POLLICI



1/2"	ESAGONO	Euro
1/2"	SERIE BUSSOLE IMPACT BRUGOLA LUNGH. 75 MM MISURE IN POLLICI: 3/16"-7/32"-1/4"-5/16"-3/8" 7/16"-1/2"-9/16"-5/8"	71,15

FEEMEC articolo	Descrizione	Euro
421091	CASSETTA METALLICA 9 PEZZI	84,00



1/2"	ESAGONO	PRO+	CROMO	Euro
1/2"	ESAGONO	PRO+	CROMO	87,98

BGS articolo	DESCRIZIONE	Euro
BGS 5481	SET 8 PEZZI, CHIAVI A BUSSOLA A MACCHINA ESAGONALI	87,98

CARATTERISTICHE

- impact
- 5, 6, 8, 10, 12, 14, 17, 19 mm
- lunghezza: 75 mm
- con scanalatura e foro per spina

RICAMBI

BGS articolo	DESCRIZIONE	Euro
BGS 5481-M5	5 MM	13,00
BGS 5481-M6	6 MM	13,00
BGS 5481-M7	7 MM	13,00
BGS 5481-M8	8 MM	13,00
BGS 5481-M10	10 MM	13,00
BGS 5481-M12	12 MM	13,00
BGS 5481-M14	14 MM	13,00
BGS 5481-M17	17 MM	13,00
BGS 5481-M19	19 MM	13,00



1/2" **CROMO** **PRO+** **ESAGONO**

BGS articolo	DESCRIZIONE	Euro
BGS 5485	SET 9 PEZZI, CHIAVI A BUSSOLA MASCHIO ESAGONALE, 5-19 MM	71,15

CARATTERISTICHE

- con scanalatura e foro per spina
- misure: 5 - 6 - 7 - 8 - 10 - 12 - 14 - 17 - 19 mm
- lunghezza: 42 mm
- attacco quadro: 1/2"

RICAMBI

BGS	DESCRIZIONE	Euro
BGS 5485-5	5 MM	11,50
BGS 5485-6	6 MM	11,50
BGS 5485-7	7 MM	11,50
BGS 5485-8	8 MM	11,50
BGS 5485-9	9 MM	11,50
BGS 5485-10	10 MM	11,50
BGS 5485-11	11 MM	11,50
BGS 5485-12	12 MM	11,50
BGS 5485-13	13 MM	11,50
BGS 5485-14	14 MM	11,50

POLLICI



1/2" **ESAGONO**

BUSSOLE ESAGONALI MASCHIO INTEGRALI
CON FORO NEL QUADRO PER SPINA ED
ANELLO - MISURE IN POLLICI

attacco: 1/2"
impronta: BRUGOLA ESAGONO

FEEMEC articolo	pollici	L mm	Euro
182 W-1/2"-1/8"	1/8"	44	15,75
182 W-1/2"-5/32"	5/32"	44	15,75
182 W-1/2"-3/16"	3/16"	44	15,75
182 W-1/2"-7/32"	7/32"	44	15,75
182 W-1/2"-1/4"	1/4"	44	15,75
182 W-1/2"-5/16"	5/16"	44	15,75
182 W-1/2"-3/8"	3/8"	47	21,64
182 W-1/2"-7/16"	7/16"	50	21,64
182 W-1/2"-1/2"	1/2"	50	21,64
182 W-1/2"-9/16"	9/16"	50	21,64
182 W-1/2"-5/8"	5/8"	50	21,64
821006	3/16"	75	16,80
821007	7/32"	75	16,80
821008	1/4"	75	16,80
821009	9/32"	75	16,80
821010	5/16"	75	16,80
821012	3/8"	75	16,80
821014	7/16"	75	23,10
821016	1/2"	75	23,10
821018	9/16"	75	23,10
821020	5/8"	75	23,10



ESAGONO

CHIAVI A BUSSOLA A MACCHINA MASCHIO ESAGONALE TIPO EXTRA LUNGO SNODATA

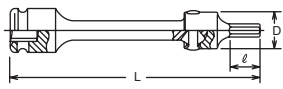

Koken articolo	mm	D mm	ℓ mm	L mm	Euro
14147M-150-6	6	25	15	150	68,45
14147M-150-8	8	25	15	150	68,45
14147M-150-10	10	25	15	150	68,45
14147M-150-12	12	25	15	150	68,45
14147M-200-6	6	25	15	200	71,64
14147M-200-8	8	25	15	200	71,64
14147M-200-10	10	25	15	200	71,64
14147M-200-12	12	25	15	200	71,64



TORX®

CHIAVI A BUSSOLA A MACCHINA MASCHIO TORX®

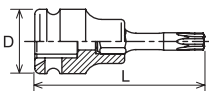

Koken articolo	T	L mm	Euro
14025-60-T20	TX 20	60	20,21
14025-60-T25	TX 25	60	20,21
14025-60-T27	TX 27	60	20,21
14025-60-T30	TX 30	60	20,21
14025-60-T40	TX 40	60	20,21
14025-60-T45	TX 45	60	20,21
14025-60-T50	TX 50	60	21,26
14025-60-T55	TX 55	60	23,16
14025-60-T60	TX 60	60	26,04
14025-100-T30	TX 30	100	24,26
14025-100-T40	TX 40	100	24,26
14025-100-T45	TX 45	100	24,26
14025-100-T50	TX 50	100	25,55
14025-100-T55	TX 55	100	27,83
14025-100-T60	TX 60	100	29,89

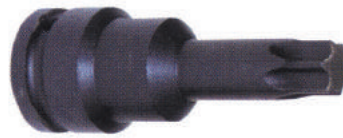

1/2"

TORX®

BUSSOLE TORX® IMPACT MASCHIO INTEGRALI CON FORO NEL QUADRO PER SPINA ED ANELLO

attacco: 1/2"
impronta: TX

FEIMEC articolo	T	L mm	Euro
BGS 5486-T20	TX 20	42	7,65
BGS 5486-T25	TX 25	42	7,65
BGS 5486-T27	TX 27	42	7,65
BGS 5486-T30	TX 30	42	7,91
BGS 5486-T40	TX 40	42	7,91
BGS 5486-T45	TX 45	42	7,91
BGS 5486-T50	TX 50	42	8,16
BGS 5486-T55	TX 55	42	8,42
BGS 5486-T60	TX 60	42	8,93
BGS 5486-T70	TX 70	42	9,44
BGS 5486-T80	TX 80	42	9,95
721025	TX 25	55	14,70
721027	TX 27	55	14,70
721030	TX 30	55	14,70
721040	TX 40	55	14,70
721045	TX 45	55	14,70
721047	TX 47	55	14,70
721050	TX 50	55	14,70
721055	TX 55	55	14,70
721060	TX 60	55	14,70
722020	TX 20	75	15,75
722025	TX 25	75	15,75
722027	TX 27	75	15,75
722030	TX 30	75	15,75
722040	TX 40	75	15,75
722045	TX 45	75	15,75
722050	TX 50	75	15,75
722055	TX 55	75	16,80
722060	TX 60	75	17,85
BGS 5469	TX 20	100	19,00
BGS 5470	TX 25	100	19,00
BGS 5467	TX 27	100	19,00
BGS 5471	TX 30	100	19,00
BGS 5472	TX 40	100	19,00
BGS 5473	TX 45	100	19,00
BGS 5474	TX 50	100	19,00
BGS 5475	TX 55	100	19,00



TORX®

SERIE 6 PZ. CHIAVI A BUSSOLA A MACCHINA MASCHIO TORX®

Koken articolo	T	Euro
RS14025/6-L60	TX30, TX40, TX45, TX50, TX55, TX60	126,03



1/2"

TORX®

BUSSOLE IMPACT TORX® MASCHIO TX 25-30-40-45-50-55-60 LUNGH. 55 MM

attacco: 1/2"
impronta: TX

FEIMEC articolo	Descrizione	Euro
621071	CASSETTA METALLICA 7 PEZZI	73,50



1/2"

TORX®

BUSSOLE IMPACT TORX® MASCHIO TX 20-25-27-30-40-45-50-55-60 LUNGH. 75 MM

attacco: 1/2"
impronta: TX

FEIMEC articolo	Descrizione	Euro
621091	CASSETTA METALLICA 9 PEZZI	78,75

TORX®	S mm	S mm	
T 6	1.70	T 40	6.70
T 7	2.00	T 45	7.90
T 8	2.30	T 50	8.90
T 9	2.50	T 55	11.30
T 10	2.70	T 60	13.30
T 15	3.30	T 70	15.60
T 20	3.90	T 80	17.60
T 25	4.50	T 90	20.00
T 27	5.00	T 100	22.20
T 30	5.60		

IMPACT 1/2"



1/2"



TORX®
CON FORO

BUSSOLE IMPACT TORX® C/FORO
TH 25-30-40-45-50-55-60 LUNGH. 55 MM

attacco: 1/2"
impronta: TH



articolo

Descrizione



Euro

621072

CASSETTA METALLICA
7 PEZZI

1

78,75



1/2"

PRO+



articolo

DESCRIZIONE

Euro

BGS 5097

**SERIE 10 PEZZI,
BUSSOLE A MACCHINA
TORX® T20 - T70,
ATT. 1/2"**

53,42

CARATTERISTICHE

- per l'uso con utensili pneumatici
- comprende i seguenti formati: T20 - T25 - T27 - T30 - T40 - T45 - T50 - T55 - T60 - T70
- lunghezza 53 mm
- attacco quadro femmina 1/2"



1/2"



PRO+



articolo

DESCRIZIONE

Euro

BGS 5480

**SET 9 PEZZI CHIAVI
A BUSSOLA
A MACCHINA TORX**

87,98

CARATTERISTICHE

- per utilizzo a macchina
- TX20-TX25-TX30-TX40-TX45-TX50-TX55-TX60-TX70
- lunghezza: 75 mm
- con scanalatura e foro per spina

RICAMBI

BGS articolo	DESCRIZIONE	Euro
BGS 5480-T20	TX 20	13,50
BGS 5480-T25	TX 25	13,50
BGS 5480-T30	TX 30	13,50
BGS 5480-T40	TX 40	13,50
BGS 5480-T45	TX 45	13,50
BGS 5480-T50	TX 50	14,50
BGS 5480-T55	TX 55	15,50
BGS 5480-T60	TX 60	16,50
BGS 5480-T70	TX 70	16,56



NEW



1/2"



PRO+



articolo

DESCRIZIONE

Euro

BGS 5486

**SET 9 PEZZI, CHIAVI
A BUSSOLA MASCHIO
TORX, TX20-TX70**

71,15

CARATTERISTICHE

- con scanalatura e foro per spina
- misure: TX20 - TX25 - TX30 - TX40 - TX45 - TX50 - TX55 - TX60 - TX70
- lunghezza: 42 mm
- attacco quadro: 1/2"

RICAMBI

BGS articolo	DESCRIZIONE	Euro
BGS5486-T20	TX 20	7,65
BGS5486-T25	TX 25	7,65
BGS5486-T27	TX 27	7,65
BGS5486-T30	TX 30	7,91
BGS5486-T40	TX 40	7,91
BGS5486-T45	TX 45	7,91
BGS5486-T50	TX 50	8,16
BGS5486-T55	TX 50	8,42
BGS5486-T60	TX 60	8,93
BGS5486-T70	TX 70	9,44
BGS5486-T80	TX 80	9,95





1/2"

XZN

BUSSOLE XZN IMPACT MASCHIO INTEGRALI CON FORO NEL QUADRO PER SPINA ED ANELLO

attacco: 1/2"
impronta: XZN

articolo	M	L mm	1	Euro
BGS 5381-M12	M 12	40	1	9,00
BGS 5381-M14	M 14	40	1	9,00
BGS 5381-M16	M 16	40	1	9,00
BGS 5381-M18	M 18	40	1	9,00
BGS 5487-M4	M 4	42	1	7,91
BGS 5487-M5	M 5	42	1	7,91
BGS 5487-M6	M 6	42	1	7,91
BGS 5487-M8	M 8	42	1	8,16
BGS 5487-M10	M 10	42	1	8,16
BGS 5482-M4	M 4	75	1	10,00
BGS 5482-M5	M 5	75	1	10,00
BGS 5482-M6	M 6	75	1	10,00
BGS 5482-M8	M 8	75	1	10,00
BGS 5482-M9	M 9	75	1	10,46
BGS 5482-M10	M 10	75	1	10,46
BGS 5482-M12	M 12	75	1	10,46
BGS 5482-M14	M 14	75	1	11,22
BGS 5482-M16	M 16	75	1	11,22
BGS 5184-M18	M 18	78	1	12,00



1/2"

XZN

BUSSOLE XZN IMPACT MASCHIO CON FORO NEL QUADRO PER SPINA ED ANELLO

attacco: 1/2"
impronta: XZN

articolo	M	L mm	1	Euro
BGS 4358	M 8	100	1	7,40
BGS 4462	M 10	100	1	5,10
BGS 4463	M 12	120	1	6,38



1/2"

XZN

PRO+

CROMO

articolo	DESCRIZIONE	Euro
BGS 5482	SET 9 PEZZI CHIAVI A BUSSOLA A MACCHINA XZN	93,08

CARATTERISTICHE

- per utilizzo a macchina
- M4-5-6-8-9-10-12-14-16
- lunghezza: 75 mm
- con scanalatura e foro per spina

RICAMBI

articolo	DESCRIZIONE	Euro
BGS 5482-M4	M 4	10,00
BGS 5482-M5	M 5	10,00
BGS 5482-M6	M 6	10,00
BGS 5482-M8	M 8	10,00
BGS 5482-M9	M 9	10,46
BGS 5482-M10	M 10	10,46
BGS 5482-M12	M 12	10,46
BGS 5482-M14	M 14	11,22
BGS 5482-M16	M 16	11,22



1/2"

PRO+

CROMO

XZN

articolo	DESCRIZIONE	Euro
BGS 5381	SET 8 PEZZI, CHIAVI A BUSSOLA XZN	72,68

CARATTERISTICHE

- misure: M12, M14, M16, M18
- per ogni misura una bussola lunghezza 40 mm e una lunghezza 75 mm

RICAMBI

articolo	DESCRIZIONE	Euro
BGS 5381-M12	XZN M12, LUNGH. 40 MM	9,00
BGS 5381-M14	XZN M14, LUNGH. 40 MM	9,00
BGS 5381-M16	XZN M16, LUNGH. 40 MM	9,00
BGS 5381-M18	XZN M18, LUNGH. 40 MM	9,00
BGS 5184-M18	XZN M18, LUNGH. 78 MM	12,00



1/2"



PRO+

XZN

articolo	DESCRIZIONE	Euro
BGS 5380	SET 6 PEZZI, BUSSOLE XZN ATTACCO 1/2"	52,28

CARATTERISTICHE

- comprende:
 - XZN, lunghezza 40 mm : M 14 - 16 - 18
 - XZN, lunghezza 75 mm : M 14 - 16 - 18
- applicazioni ad esempio: pinza freno VW Touareg (asse posteriore), MB Atego
- per uso con avvitatori pneumatici

RICAMBI

articolo	DESCRIZIONE	Euro
BGS 5381-M14	XZN M14, LUNGH. 40 MM	9,00
BGS 5381-M16	XZN M16, LUNGH. 40 MM	9,00
BGS 5381-M18	XZN M18, LUNGH. 40 MM	9,00
BGS 5482-M14	XZN M14, LUNGH. 75 MM	11,22
BGS 5482-M16	XZN M16, LUNGH. 75 MM	11,22
BGS 5184-M18	XZN M18, LUNGH. 78 MM	12,00

XZN	S mm	S mm
M 4	3,60	M12 11,50
M 5	4,80	M14 13,30
M 6	6,10	M16 15,70
M 8	7,30	M18 16,90
M10	9,70	

IMPACT 1/2"



BGS articolo	DESCRIZIONE	Euro
BGS 5487	SET 9 PEZZI, CHIAVI A BUSSOLA MASCHIO XZN, M4-M16	71,15

CARATTERISTICHE

- con scanalatura e foro per spina
- misure: M4 - M5 - M6 - M8 - M9 - M10 - M12 - M14 - M16
- lunghezza: 42 mm
- attacco quadro: 1/2"

RICAMBI

BGS	DESCRIZIONE	Euro
BGS 5487-M4	M 4	7,91
BGS 5487-M5	M 5	7,91
BGS 5487-M6	M 6	7,91
BGS 5487-M8	M 8	8,16
BGS 5487-M10	M 10	8,16
BGS 5381-M12	M 12	9,00
BGS 5381-M14	M 14	9,00
BGS 5381-M16	M 16	9,00



TORX® XZN ESAGONO



PRO+



BGS articolo	DESCRIZIONE	Euro
BGS 5484	SET 26 PEZZI, CHIAVI A BUSSOLA A MACCHINA, TORX /XZN/ESAGONO	275,00

CARATTERISTICHE

- 9 chiavi a bussola Torx maschio: TX25-TX30-TX40-TX45-TX50-TX55-TX60-TX70-TX80
- 8 chiavi a bussola esagono maschio: 5-6-8-10-12-14-17-19 mm
- 9 chiavi a bussola XZN: M5-M6-M8-M9-M10-M12-M14-M16-M18
- lunghezza: 75 mm



PRO+



BGS articolo	DESCRIZIONE	Euro
BGS 5483	SET 9 PEZZI CHIAVI A A MACCHINA RIBE	98,75

CARATTERISTICHE

- per utilizzo a macchina
- 5, 6, 7, 8, 9, 10, 12, 13, 14 mm
- lunghezza: 75 mm
- con scanalatura e foro per spina

RICAMBI

BGS	DESCRIZIONE	Euro
BGS 5483-M5	M 5	10,00
BGS 5483-M6	M 6	10,00
BGS 5483-M7	M 7	10,00
BGS 5483-M8	M 8	10,46
BGS 5483-M9	M 9	10,71
BGS 5483-M10	M 10	10,71
BGS 5483-M12	M 12	12,00
BGS 5483-M13	M 13	12,50
BGS 5483-M14	M 14	13,00



13134-SC



BUSSOLA PORTA INSERTI DA 7/16"

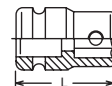

Koken articolo	D mm	L mm	1	Euro
14134	25	38	1	18,65

RICAMBI

Koken articolo	DESCRIZIONE	Euro
13134-SC	GRANO DI RICAMBIO M8X5; ESAGONO 4 MM	1,10

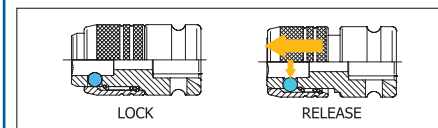

BUSSOLA PORTA INSERTI CON SGANCIO RAPIDO 7/16"



Koken articolo	D mm	L mm	1	Euro
14142-F11.2	25	46	1	45,35



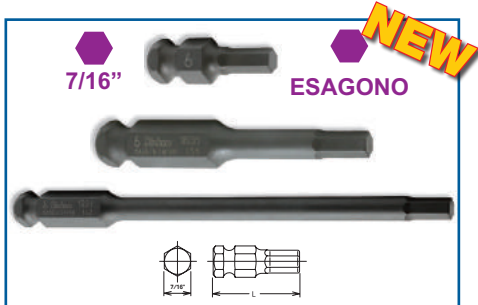

INSERTO CON MASCHIO ESAGONALE

Koken articolo	mm	L mm		Euro
183H-35-3	3	35	1	6,90
183H-35-4	4	35	1	6,90
183H-35-5	5	35	1	6,90
183H-35-6	6	35	1	6,90
183H-35-7	7	35	1	7,12
183H-35-8	8	35	1	7,12
183H-35-10	10	35	1	7,12
183H-35-11	11	35	1	11,52
183H-35-12	12	35	1	11,52
183H-35-14	14	35	1	11,96
183H-35-16	16	35	1	11,96
183H-35-17	17	35	1	11,96
183H-35-18	18	35	1	17,77
183H-35-19	19	35	1	17,77
183H-75-3	3	75	1	9,02
183H-75-4	4	75	1	9,02
183H-75-5	5	75	1	9,02
183H-75-6	6	75	1	9,02
183H-75-7	7	75	1	9,02
183H-75-8	8	75	1	9,02
183H-75-10	10	75	1	9,02
183H-75-11	11	75	1	13,09
183H-75-12	12	75	1	13,48
183H-75-14	14	75	1	14,47
183H-150-4	4	150	1	13,75
183H-150-5	5	150	1	13,75
183H-150-6	6	150	1	13,75
183H-150-8	8	150	1	13,75
183H-150-10	10	150	1	13,75
183H-150-12	12	150	1	19,88



BUSSOLA MASCHIO ESAGONALE IN DUE PARTI:

BUSSOLA + INSERTO MASCHIO ESAGONALE

Koken articolo	mm	L mm		Euro
14134M-58-3	3	58	1	25,33
14134M-58-4	4	58	1	25,33
14134M-58-5	5	58	1	25,33
14134M-58-6	6	58	1	25,33
14134M-58-7	7	58	1	25,77
14134M-58-8	8	58	1	25,77
14134M-58-10	10	58	1	25,77
14134M-58-12	12	58	1	30,17
14134M-58-14	14	58	1	30,61
14134M-98-3	3	98	1	27,67
14134M-98-4	4	98	1	27,67
14134M-98-5	5	98	1	27,67
14134M-98-6	6	98	1	27,67
14134M-98-7	7	98	1	27,67
14134M-98-8	8	98	1	27,67
14134M-98-10	10	98	1	27,67
14134M-98-12	12	98	1	31,74
14134M-98-14	14	98	1	32,67

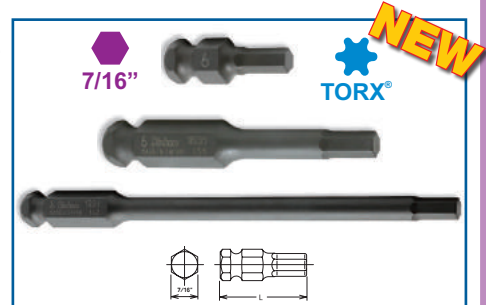

INSERTO CON MASCHIO TORX®

Koken articolo		L mm		Euro
183T-35-T25	TX 25	35	1	8,58
183T-35-T30	TX 30	35	1	8,58
183T-35-T40	TX 40	35	1	8,58
183T-35-T45	TX 45	35	1	8,58
183T-35-T50	TX 50	35	1	8,80
183T-35-T55	TX 55	35	1	8,80
183T-35-T60	TX 60	35	1	14,27
183T-75-T30	TX 30	75	1	9,52
183T-75-T40	TX 40	75	1	9,52
183T-75-T45	TX 45	75	1	9,52
183T-75-T50	TX 50	75	1	9,52
183T-75-T55	TX 55	75	1	9,52
183T-75-T60	TX 60	75	1	16,36
183T-150-T30	TX 30	150	1	14,80
183T-150-T40	TX 40	150	1	14,80
183T-150-T45	TX 45	150	1	14,80
183T-150-T50	TX 50	150	1	14,80
183T-150-T55	TX 55	150	1	14,80

SOSTITUISCE SERIE 107-11 KOKEN

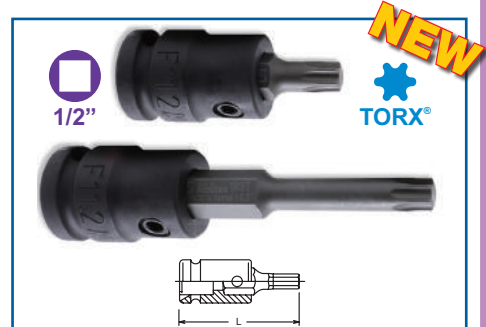

BUSSOLA MASCHIO ESAGONALE IN DUE PARTI:

BUSSOLA + INSERTO MASCHIO TORX®

TORX®	S mm	S mm	
T 6	1.70	T 40	6.70
T 7	2.00	T 45	7.90
T 8	2.30	T 50	8.90
T 9	2.50	T 55	11.30
T 10	2.70	T 60	13.30
T 15	3.30	T 70	15.60
T 20	3.90	T 80	17.60
T 25	4.50	T 90	20.00
T 27	5.00	T 100	22.20
T 30	5.60		

Koken articolo		L mm		Euro
14134T-58-T30	TX 30	58	1	27,23
14134T-58-T40	TX 40	58	1	27,23
14134T-58-T45	TX 45	58	1	27,23
14134T-58-T50	TX 50	58	1	27,45
14134T-58-T55	TX 55	58	1	27,45
14134T-58-T60	TX 60	58	1	32,51
14134T-98-T30	TX 30	98	1	28,16
14134T-98-T40	TX 40	98	1	28,16
14134T-98-T45	TX 45	98	1	28,16
14134T-98-T50	TX 50	98	1	28,16
14134T-98-T55	TX 55	98	1	28,16
14134T-98-T60	TX 60	98	1	34,51



INSERTO CON MASCHIO ESAGONALE

Koken articolo	POLLICI	L mm		Euro
183H-35-3/16	3/16"	35	1	7,34
183H-35-7/32	7/32"	35	1	7,34
183H-35-1/4	1/4"	35	1	7,34
183H-35-5/16	5/16"	35	1	7,84
183H-35-3/8	3/8"	35	1	7,84
183H-35-7/16	7/16"	35	1	7,84
183H-35-1/2	1/2"	35	1	13,15

IMPACT 1/2"

7/16"



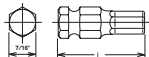

TORXplus

NEW



INSERTO CON MASCHIO TORX PLUS®

Kokon articolo		L mm		Euro
183T-35-30IP	30IP	35	1	10,04
183T-35-40IP	40IP	35	1	10,04
183T-35-45IP	45IP	35	1	10,04
183T-35-50IP	50IP	35	1	10,45
183T-35-55IP	55IP	35	1	10,45
183T-35-60IP	60IP	35	1	17,60
183T-75-30IP	30IP	75	1	11,85
183T-75-40IP	40IP	75	1	11,85
183T-75-45IP	45IP	75	1	11,85
183T-75-50IP	50IP	75	1	11,85
183T-75-55IP	55IP	75	1	11,85
183T-75-60IP	60IP	75	1	20,10

7/16"



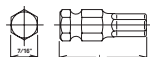

XZN

NEW



INSERTO CON MASCHIO XZN

Kokon articolo		L mm		Euro
183X-35-M 4	M 4	35	1	8,83
183X-35-M 5	M 5	35	1	8,83
183X-35-M 6	M 6	35	1	8,83
183X-35-M 8	M 8	35	1	8,83
183X-35-M10	M10	35	1	9,35
183X-35-M12	M12	35	1	13,34
183X-35-M14	M14	35	1	14,27
183X-75-M 4	M 4	75	1	10,45
183X-75-M 5	M 5	75	1	10,45
183X-75-M 6	M 6	75	1	10,45
183X-75-M 8	M 8	75	1	10,45
183X-75-M10	M10	75	1	10,62
183X-75-M12	M12	75	1	15,79
183X-75-M14	M14	75	1	16,89
183X-150-M 5	M 5	150	1	17,19
183X-150-M 6	M 6	150	1	17,19
183X-150-M 8	M 8	150	1	21,42
183X-150-M10	M10	150	1	21,42
183X-150-M12	M12	150	1	26,07

1/2"



XZN

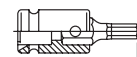

NEW



BUSSOLA MASCHIO ESAGONALE

IN DUE PARTI:

BUSSOLA + INSERTO MASCHIO XZN

Kokon articolo		L mm		Euro
14134X-58-M5	M 5	58	1	27,23
14134X-58-M6	M 6	58	1	27,23
14134X-58-M8	M 8	58	1	27,23
14134X-58-M10	M10	58	1	27,89
14134X-58-M12	M12	58	1	31,57
14134X-58-M14	M14	58	1	32,51
14134X-98-M5	M 5	98	1	28,77
14134X-98-M6	M 6	98	1	28,77
14134X-98-M8	M 8	98	1	28,77
14134X-98-M10	M10	98	1	28,93
14134X-98-M12	M12	98	1	33,91
14134X-98-M14	M14	98	1	35,06

1/2"



TORXplus

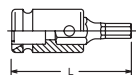

NEW



BUSSOLA MASCHIO ESAGONALE

IN DUE PARTI:

BUSSOLA + INSERTO MASCHIO TORX PLUS®

Kokon articolo		L mm		Euro
14134T-58-30IP	30IP	58	1	28,33
14134T-58-40IP	40IP	58	1	28,33
14134T-58-45IP	45IP	58	1	28,33
14134T-58-50IP	50IP	58	1	28,55
14134T-58-55IP	55IP	58	1	28,55
14134T-58-60IP	60IP	58	1	35,28
14134T-98-30IP	30IP	98	1	30,06
14134T-98-40IP	40IP	98	1	30,06
14134T-98-45IP	45IP	98	1	30,06
14134T-98-50IP	50IP	98	1	30,06
14134T-98-55IP	55IP	98	1	30,06
14134T-98-60IP	60IP	98	1	37,68

XZN

S mm

S mm



M 4	3,60	M12	11,50
M 5	4,80	M14	13,30
M 6	6,10	M16	15,70
M 8	7,30	M18	16,90
M10	9,70		

TORXplus

S mm

S mm



8 IP	2.30	30 IP	5.60
9 IP	2.50	40 IP	6.70
10 IP	2.70	45 IP	7.90
15 IP	3.30	50 IP	8.90
20 IP	3.90	55 IP	11.30
25 IP	4.50	60 IP	13.30
27 IP	5.00		

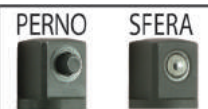
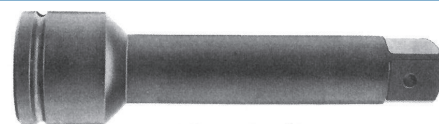

PROLUNGHE PER BUSSOLE "POWER IMPACT" MASCHIO/FEMMINA

FEARMEC articolo		L mm		Euro
97-6	PERNO	50	1	22,05
97-6-75	PERNO	75	1	15,75
97-7	PERNO	125	1	17,85
97-8	PERNO	175	1	20,61
97-9	PERNO	250	1	22,77
97-6 S	SFERA	50	1	22,05
97-6-75 S	SFERA	75	1	15,75
97-7 S	SFERA	125	1	17,85
97-8 S	SFERA	175	1	20,61
97-9 S	SFERA	250	1	22,77
97-9-300 S	SFERA	300	1	35,70
97-9-460 S	SFERA	460	1	48,80
97-9-610 S	SFERA	610	1	54,23
97-9-915 S	SFERA	915	1	86,76



PROLUNGA

Koken articolo	D mm	PERNO	L mm		Euro
14760-50P	30	PERNO	50	1	20,65
14760-75P	30	PERNO	75	1	20,65
14760-100P	30	PERNO	100	1	22,47
14760-125P	30	PERNO	125	1	22,47
14760-150P	30	PERNO	150	1	25,60
14760-175P	30	PERNO	175	1	25,77
14760-200P	30	PERNO	200	1	27,45
14760-250P	30	PERNO	250	1	27,45
NEW 14760-50	30	FORO	50	1	20,65
NEW 14760-75	30	FORO	75	1	20,65
NEW 14760-100	30	FORO	100	1	22,47
NEW 14760-125	30	FORO	125	1	22,47
NEW 14760-150	30	FORO	150	1	25,60
NEW 14760-175	30	FORO	175	1	25,77
NEW 14760-200	30	FORO	200	1	27,45
NEW 14760-250	30	FORO	250	1	27,45



SFERA

BGS articolo	DESCRIZIONE	Euro
BGS 190	SNODO A MACCHINA	20,00

CARATTERISTICHE

- finitura nera
- lunghezza: 70 mm
- con sfera di tenuta

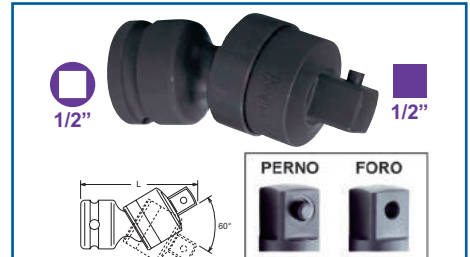

SNODO UNIVERSALE

Koken articolo	PERNO	L mm		Euro
14770-P	PERNO	74	1	44,41
NEW 14770	FORO	74	1	44,41



NEW

BGS articolo	DESCRIZIONE	Euro
BGS 9459	SET 3 PEZZI, SNODI	38,00

CARATTERISTICHE

- con scanalatura e foro per spina
- comprende:
 - snodo 1/4" F - 1/4" M
 - snodo 3/8" F - 3/8" M
 - snodo 1/2" F - 1/2" M

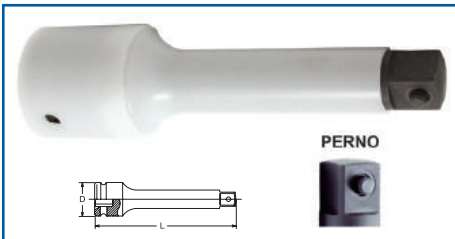

PERNO

PROLUNGA CON RIVESTIMENTO

Koken articolo	D mm	L mm		Euro
14760-125P.FR	34.2	125	1	134,28
14760-250P.FR	34.2	250	1	158,57

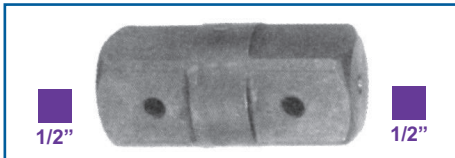

1/2"

1/2"

PROLUNGHE PER BUSSOLE "POWER IMPACT" MASCHIO/MASCHIO

FERMEC articolo	L mm		Euro
Z0802	50	1	15,75
Z0803	76	1	15,75
Z0805	127	1	18,90
Z0810	254	1	31,50

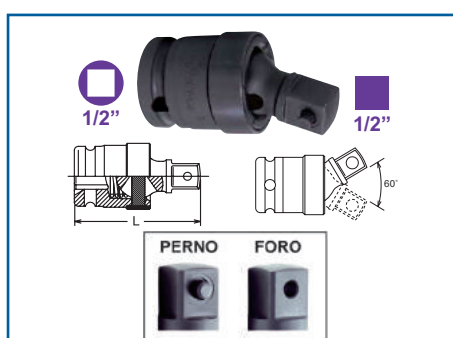

SNODO UNIVERSALE

Koken articolo	PERNO	L mm		Euro
14771-P	PERNO	65	1	44,41
NEW 14771	FORO	65	1	44,41

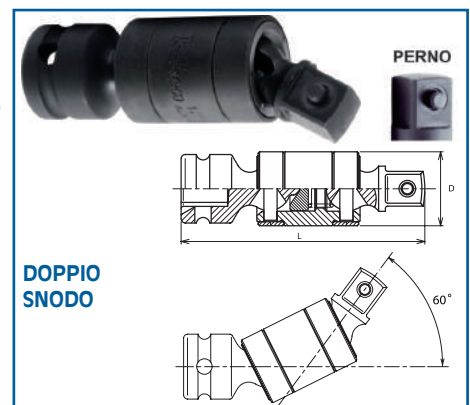

PERNO

DOPPIO SNODO

Koken articolo	D mm	L mm		Euro
14772-P	27	90	1	69,80

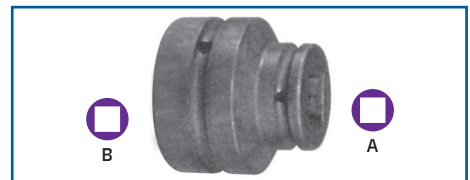

B

A

RIDUZIONI PER BUSSOLE "POWER IMPACT" FEMMINA/FEMMINA

FERMEC articolo	B	A	L mm		Euro
AN 0808	1/2"	1/2"	33	1	18,90
AN 1208	3/4"	1/2"	49	1	39,90



1/2"

3/8"

RACCORDO DI RIDUZIONE QUADRO MASCHIO 3/8" E FEMMINA 1/2"

Koken articolo	PERNO	L mm		Euro
14433A-P	PERNO	37,5	1	18,87
NEW 14433A	FORO	37,5	1	18,87

PAG 595 CON SFERA

RIDUZIONI IMPACT

RACCORDO DI RIDUZIONE QUADRO MASCHIO 5/8" E FEMMINA 1/2"

Koken articolo	L mm	Euro
14455A	42	23,10

RACCORDO DI RIDUZIONE QUADRO MASCHIO 3/4" E FEMMINA 1/2"

Koken articolo	L mm	Euro
14466A	44	20,38

MANDRINO CON SGANCIO RAPIDO PER BUSSOLE "POWER IMPACT"

attacco: Quadro femmina
impronta: DIN 3126, E 11,2 - E 6,35

articolo	F	M	L mm	Euro
195-SWF	1/4"	1/4"	41	42,00
196-SWF	3/8"	3/8"	46	42,00
197-SWF	1/2"	1/2"	60	46,20
199-SWF	3/4"	3/4"	78	114,35
1991-SWF	1"	1"	100	131,25
12222 AL	1/4"	1/4"	35	50,44
13333 AL	3/8"	3/8"	45	53,05
14444 AL	1/2"	1/2"	55	58,27
16666 AL	3/4"	3/4"	75	121,94
18888 AL	1"	1"	95	178,01

ARTICOLO NON SOGGETTO A GARANZIA

RACCORDI DI RIDUZIONE "POWER IMPACT" MASCHIO/FEMMINA

articolo	F	M	L mm	Euro
96-00	PERNO 1/4"	3/8"	32	12,47
96-0	PERNO 3/8"	1/4"	35	12,47
96-1	PERNO 3/8"	1/2"	45	12,47
96-01	PERNO 1/2"	1/4"	38	13,00
96-2	PERNO 1/2"	3/8"	45	13,56
96-3	FORO 5/8"	1/2"	50	20,07
96-4	PERNO 3/4"	1/2"	70	23,32
96-5	FORO 3/4"	5/8"	70	26,58
96-6	FORO 5/8"	3/4"	70	20,61
96-7	FORO 1/2"	5/8"	50	16,26
96-8	FORO 3/4"	1"	70	28,74
96-9	FORO 1"	3/4"	70	35,79
96-10	PERNO 1"	1/2"	70	65,00
96-11	FORO 1/2"	3/4"	50	17,89
96-12	FORO 1 1/2"	1"	115	121,80
96-13	FORO 1"	1 1/2"	115	51,51
96-14	FORO 2 1/2"	1 1/2"	115	379,60
96-15	FORO 1 1/2"	2 1/2"	120	260,30
96-16	FORO 1 1/4"	1"	140	126,00
96-17	FORO 1 3/4"	1 1/2"	150	294,00

RACCORDI DI RIDUZIONE MAGNETICI "POWER IMPACT" A SCOMPARSA - SPAZI RIDOTTI

articolo	F	M	L mm	Euro
698-00	1/4"	3/8"	17	10,00
698-0	1/4"	1/2"	22	10,00
698-1	3/8"	1/2"	22	10,50
698-11	1/2"	3/4"	30	14,70
698-8	3/4"	1"	35	21,00
698-13	1"	1 1/2"	50	31,50
698-15	1 1/2"	2 1/2"	60	210,00
698	CASSETTA 4 PZ. CONTENUTO: 1 PZ. 698-00 1 PZ. 698-1 1 PZ. 698-11 1 PZ. 698-8			63,00

RACCORDI DI RIDUZIONE "POWER IMPACT" MASCHIO/FEMMINA CON SFERA DI TENUTA NEL QUADRO MASCHIO

articolo	F	M	L mm	Euro
696-00 S	1/4"	3/8"	26	10,00
696-0 S	3/8"	1/4"	32	10,00
696-01 S	1/2"	1/4"	36	10,00
696-1 S	3/8"	1/2"	36	10,00
696-2 S	1/2"	3/8"	38	10,50
696-11 S	1/2"	3/4"	48	12,60
696-4 S	3/4"	1/2"	56	16,80
696-8 S	3/4"	1"	63	22,05
696-9 S	1"	3/4"	75	28,35



articolo	DESCRIZIONE	Euro
BGS 200	SET 6 PEZZI RIDUZIONI A MACCHINA	46,92

CARATTERISTICHE		
• rivestimento specifico nero opaco		
CONTENUTO		
• 1/4" F X 3/8" M, coppia massima 60 Nm		
• 3/8" F X 1/4" M, coppia massima 60 Nm		
• 3/8" F X 1/2" M, coppia massima 200 Nm		
• 1/2" F X 3/8" M, coppia massima 200 Nm		
• 1/2" F X 3/4" M, coppia massima 500 Nm		
• 3/4" F X 1/2" M, coppia massima 500 Nm		
RICAMBI		
articolo	DESCRIZIONE	Euro
BGS 200-LEER	CASSETTA VUOTA	5,46



PRO+ **CROMO**

BGS articolo	DESCRIZIONE	Euro
BGS 25140	SET 11 PEZZI RIDUZIONI E SNODI A MACCHINA	113,48

CARATTERISTICHE

- rivestimento specifico nero opaco

CONTENUTO

- 1/4" F x 3/8" M
- 3/8" F x 1/4" M
- 3/8" F x 1/2" M
- 1/2" F x 3/8" M
- 1/2" F x 3/4" M
- 3/4" F x 1/2" M
- 3/4" F x 1" M
- 1" F x 3/4" M
- snodi da 1/4", 3/8", 1/2"



RACCORDI DI RIDUZIONE A MANDRINO CON SGANCIO RAPIDO "POWER IMPACT"

FERMEC articolo	F	M	L mm	Euro
691-0 SWF	3/8"	1/4"	55	31,50
691-1 SWF	3/8"	1/2"	60	31,50
691-2 SWF	1/2"	3/8"	55	36,75
691-11 SWF	1/2"	3/4"	75	42,00
691-4 SWF	3/4"	1/2"	70	42,00
691-9 SWF	1"	3/4"	90	73,50



SPINE ACCIAIO PER BUSSOLE

Koken articolo	Ø	L mm	Euro
1200 A	1/4"	10,2	0,44
1301 A	3/8"	14,5	0,44
1302 A	3/8"	17,5	0,44
1401 A	1/2"	20	0,74
1402 A	1/2"	25	0,74
1500 A	5/8"	30	0,74
1601 A	3/4"	35	0,83
1602 A	3/4"	45	0,94
1801 A	1"	45	0,94
1802 A	1"	75	1,82
1701 A	1 1/2"	75	1,98
1702 A	1 1/2"	110	3,99
1901 A	2 1/2"	110	4,46
1902 A	2 1/2"	155	5,06
2001 A	3 1/2"	155	8,36
2002 A	3 1/2"	180	6,90

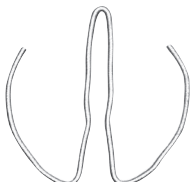

MOLLA DI SICUREZZA PER BUSSOLE

Koken articolo	Ø	Euro
1301C	3/8"	0,94
1302C	3/8"	0,94
1401C	1/2"	1,18
1402C	1/2"	1,18
1600C	3/4"	2,26
1801C	1"	2,23
1802C	1"	7,87
1700C	1 1/2"	8,22

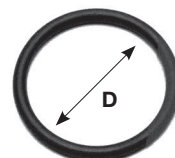

ANELLI DI GOMMA PER BUSSOLE

Koken articolo	Ø	D mm	Euro
1200 B	1/4"	9	0,72
1301 B	3/8"	13	0,83
1302 B	3/8"	16	0,88
1401 B	1/2"	19	1,02
1402 B	1/2"	24	1,10
1500 B	5/8"	28	1,35
1601 B	3/4"	36	1,46
1602 B	3/4"	45	2,15
1801 B	1"	45	1,98
1802 B	1"	75	8,72
1701 B	1 1/2"	75	8,58
1702 B	1 1/2"	114	21,42
1901 B	2 1/2"	114	22,25
1902 B	2 1/2"	158	27,72
2001 B	3 1/2"	158	82,80
2002 B	3 1/2"	183	91,88



ESTRATTORE PER MOLLE DI SICUREZZA

Koken articolo	Ø	Euro
149	3/8" - 1/2"	1,57
152	3/4" - 1"	1,68



SET MOLLE DI SICUREZZA PER BUSSOLE

Koken articolo	nr.	Euro
PK1301 C-10	10	13,92
PK1302 C-10	10	13,92
PK1401 C-10	10	16,86
PK1402 C-10	10	16,86
PK1600 C-10	10	25,82
PK1801 C-10	10	26,32



ESAGONO

CHIAVI A BUSSOLA
GUIDATE ANTI VIBRAZIONI
BOCCA ESAGONALE

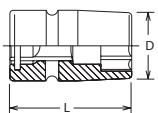

Koken articolo	mm	D mm	L mm	mm	Euro
NV14400M-12	12	19.5	52	1	34,65
NV14400M-13	13	20.7	52	1	34,65
NV14400M-14	14	22	54	1	34,65
NV14400M-15	15	23.2	54	1	37,07
NV14400M-16	16	24.5	54	1	37,07
NV14400M-17	17	25.7	54	1	37,07
NV14400M-18	18	27	54	1	37,07
NV14400M-19	19	28.2	54	1	37,07
NV14400M-21	21	30.7	54	1	41,44
NV14400M-22	22	32	54	1	41,44
NV14400M-23	23	33.2	54	1	42,24
NV14400M-24	24	34.5	54	1	42,24

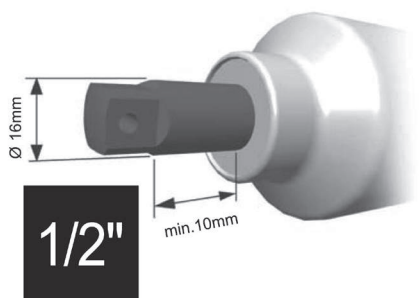

ESAGONO

CHIAVI A BUSSOLA
GUIDATE ANTI
VIBRAZIONI
BOCCA ESAGONALE
EXTRA LUNGHE



Koken articolo	mm	D mm	L mm	mm	Euro
NV14145M-100-10	10	15.5	100	1	47,36
NV14145M-100-12	12	18	100	1	47,36
NV14145M-100-13	13	19	100	1	47,36
NV14145M-100-14	14	21	100	1	47,36
NV14145M-100-15	15	22	100	1	49,56
NV14145M-100-16	16	24	100	1	49,56
NV14145M-100-17	17	25	100	1	49,56
NV14145M-100-18	18	26	100	1	49,56
NV14145M-100-19	19	28	100	1	49,56
NV14145M-150-10	10	15.5	150	1	73,73
NV14145M-150-12	12	18	150	1	73,73
NV14145M-150-13	13	19	150	1	73,73
NV14145M-150-14	14	21	150	1	73,73
NV14145M-150-15	15	22	150	1	76,23
NV14145M-150-16	16	24	150	1	76,23
NV14145M-150-17	17	25	150	1	76,23
NV14145M-150-18	18	26	150	1	76,23
NV14145M-150-19	19	28	150	1	76,23
NV14145M-200-10	10	15.5	200	1	74,64
NV14145M-200-12	12	18	200	1	74,64
NV14145M-200-13	13	19	200	1	74,64
NV14145M-200-14	14	21	200	1	74,64
NV14145M-200-15	15	22	200	1	77,52
NV14145M-200-16	16	24	200	1	77,52
NV14145M-200-17	17	25	200	1	77,52
NV14145M-200-18	18	26	200	1	77,52
NV14145M-200-19	19	28	200	1	77,52



PROLUNGA ANTI VIBRAZIONI

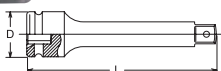

Koken articolo	D mm	L mm	mm	Euro
NV14760-75P	25	75	1	50,33
NV14760-125P	25	125	1	58,36
NV14760-175P	25	175	1	60,09
NV14760-250P	25	250	1	63,11



1/2"

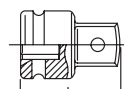

3/8"

ADATTATORE ANTI VIBRAZIONI
CON ATTACCO QUADRO
MASCHIO 3/8" E FEMMINA 1/2"

Koken articolo	L mm	mm	Euro
NV14433A-75P	75	1	42,82
NV14433A-100P	100	1	48,68
NV14433A-150P	150	1	51,29

1/2"

1/4" E
7/16"

ELIMINAZIONE DELLE VIBRAZIONI
LA PROLUNGA DEL MANDRINO CALZA
SULLA PARETE CILINDRICA DELL' ALBERO
DELL' AVVITATORE
ATTENZIONE: CONTROLLARE LA
LUNGHEZZA DELL' ALBERO!

attacco: Quadro femmina 3/8"-1/2"
impronta: E 6,35

FEEMEC articolo	mm	L mm	mm	Euro
NV 1214 1/2"	1/4" E	60	1	50,40
NV 12716 1/2"	7/16"	63	1	78,75

1/2"



7/16"

BUSSOLA
PORTAINSERI
ANTI
VIBRAZIONI
DA 7/16"

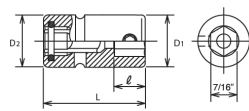

Koken articolo	D mm	L mm	mm	Euro
NV14134	22.5	55	1	90,61

1/2"



1/2"

MANDRINI ANTIVIBRAZIONE PORTABUSSOLE
E SGANCIO RAPIDO
ATTENZIONE: CONTROLLARE LA LUNGHEZZA
DELL' ALBERO!

FEEMEC articolo	mm	L mm	mm	Euro	
NV197	1/2"	1/2"	100	1	73,50

Guidate antivibrazioni

NOTE

A series of horizontal dotted lines for taking notes.

IMPACT Ø 1/2"



CASSETTE METALLICHE PORTA-BUSSOLE

FERMEC articolo	Dimensioni (lunghezza x larghezza x altezza) mm		Euro
CASS-2510	280 x 100 x 40 mm	1	26,25
CASS-3112	310 x 120 x 80 mm	1	39,90
CASS-3211	320 x 115 x 50 mm	1	42,00
CASS-6213	610 x 130 x 85 mm	1	55,00

NOTE

- a richiesta assortimento di bussole a macchina in cassetta metallica

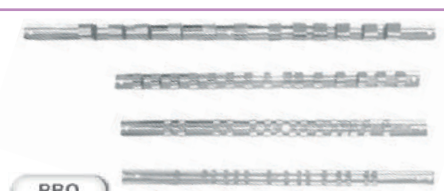

PRO

GUIDE PORTA BUSSOLE CON CLIP

BG articolo	Numero Clip	Euro
BGS 2316 1/4"	7	2,93
BGS 2317 3/8"	7	3,19
BGS 2318 1/2"	7	3,32
BGS 2120 1/4"	15	4,08
BGS 2330 3/8"	15	4,59
BGS 2540 1/2"	15	4,46
BGS 3460 3/4"	12	8,93

CARATTERISTICHE

- cromato satinato

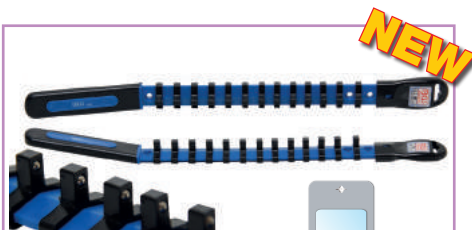

GUIDE PORTA BUSSOLE CON CLIP

BG articolo	Numero Clip	Euro
BGS 9193 1/4"	13	3,83
BGS 9194 3/8"	11	4,08
BGS 9195 1/2"	9	4,34

CARATTERISTICHE

- clip con sfere di tenuta



GUIDE MAGNETICHE PORTA BUSSOLE CON CLIP



Koken articolo	Nr. Clip	L mm		Euro
RSAL200-1/4x12	12	200	1	37,68
RSAL200-3/8x8	8	200	1	35,56
RSAL300-3/8x12	12	300	1	42,90
RSAL300-1/2x10	10	300	1	44,85



GUIDE PORTA BUSSOLE PER MOLLE IN ACCIAIO DA 1/4" - 3/8" - 1/2" - 3/4"

Koken articolo	L mm		Euro
R 158	158	1	2,52
R 251	251	1	2,56
R 300	300	1	2,62
R 400	400	1	2,71



GUIDE MAGNETICHE PORTA BUSSOLE CON CLIP

BG articolo	Numero Clip	L mm	Euro
BGS 9342 1/4"	12	310	22,19
BGS 9343 3/8"	12	310	22,44
BGS 9344 1/2"	12	310	22,70

CARATTERISTICHE

- clip con sfera per bussole realizzate in plastica rinforzata
- magneti rivestiti in gomma protettiva



GUIDE PORTA BUSSOLE MAGNETICHE PER MOLLE IN PLASTICA



Koken articolo	L mm		Euro
RSAL-200	200	1	31,54
RSAL-300	300	1	36,63





MOLLE IN ACCIAIO PER GUIDE

Koken articolo	Euro
C 14 1/4"	0,34
C 38 3/8"	0,34
C 12 1/2"	0,34
C 34 3/4"	0,50



MOLLE IN PLASTICA PER GUIDE

Koken articolo			Euro
CLIP-1/4	1/4"	1	0,55
CLIP-3/8	3/8"	1	0,55
CLIP-1/2	1/2"	1	0,55

GUIDA MAGNETICA PER MOLLE PORTA
BUSSOLE DA 1/4" - 3/8" - 1/2" - 3/4"

FERMEC articolo	L mm		Euro
MAG300	300	1	20,50



BARRA PORTABUSSOLE MAGNETICA,

BGS articolo		Numero vani	Euro
BGS 3011-1	1/4"	10	5,36
BGS 3011-2	3/8"	12	8,16
BGS 3011-3	1/2"	10	11,09

CARATTERISTICHE

- le bussole sono trattenute grazie ad una banda magnetica



1/4" 3/8" 1/2" 3/4" 1"

CLIP X ATTACCO QUADRO FEMMINA

BGS articolo		Euro
BGS HANGER-1	1/4"	1,91
BGS HANGER-2	3/8"	1,91
BGS HANGER-3	1/2"	1,91
BGS HANGER-4	3/4"	2,04
BGS HANGER-5	1"	2,04

CARATTERISTICHE

- clip in plastica con quadro maschio
- ad esempio per esposizione bussole

NOTE



ESAGONO

**CHIAVI A BUSSOLA
A MANO BOCCA
ESAGONALE**

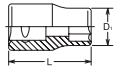

Koken articolo	mm	D mm	L mm		Euro
NEW 6400M-14	14	22.1	50	1	13,94
NEW 6400M-16	16	24.6	50	1	13,94
6400M-17	17	26	50	1	13,94
6400M-18	18	27	50	1	13,94
6400M-19	19	28.5	50	1	13,94
6400M-20	20	29.5	50	1	13,94
6400M-21	21	31	50	1	13,94
6400M-22	22	32	50	1	13,94
6400M-23	23	33.5	50	1	13,94
6400M-24	24	34.5	50	1	13,94
6400M-25	25	36	50	1	14,91
6400M-26	26	37	50	1	14,91
6400M-27	27	38.5	53	1	15,84
6400M-28	28	39.5	53	1	15,84
6400M-29	29	41	53	1	18,18
6400M-30	30	42	55	1	18,18
6400M-31	31	43.5	55	1	18,18
6400M-32	32	44.5	57	1	18,18
6400M-33	33	46	57	1	21,84
6400M-34	34	47	57	1	21,84
6400M-35	35	48.5	57	1	21,84
6400M-36	36	49.5	59	1	24,39
6400M-37	37	51	59	1	24,39
6400M-38	38	52	59	1	25,66
6400M-39	39	53.5	59	1	28,49
6400M-40	40	54.5	59	1	29,15
6400M-41	41	56	62	1	29,15
6400M-42	42	57	62	1	31,35
6400M-43	43	58.5	62	1	33,14
6400M-44	44	59.5	62	1	35,59
6400M-45	45	61	62	1	35,59
6400M-46	46	62	68	1	35,59
6400M-47	47	63.5	68	1	38,97
6400M-48	48	64.5	68	1	38,97
6400M-50	50	67	68	1	43,37
6400M-52	52	69.5	72	1	50,88
6400M-54	54	72	72	1	52,20
6400M-55	55	73.5	72	1	52,20
6400M-56	56	74.5	72	1	54,09
6400M-57	57	76	72	1	54,09
6400M-58	58	77	72	1	57,56
6400M-60	60	79.5	76	1	69,03
6400M-63	63	83.5	76	1	71,91
6400M-65	65	86	80	1	82,25
6400M-70	70	92	84	1	89,65
6400M-75	75	98.5	86	1	117,15
NEW 6400M-78	78	102.1	86	1	125,02
6400M-80	80	104.5	90	1	125,04
6400M-85	85	111	90	1	136,59

POLLICI



ESAGONO

**CHIAVI A BUSSOLA
A MANO BOCCA
ESAGONALE**

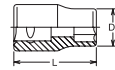

Koken articolo	pollici	D mm	L mm		Euro
NEW 6400A-5/8	5/8"	24.6	50	1	15,02
6400A-11/16	11/16"	27	50	1	15,02
6400A-3/4	3/4"	28.5	50	1	15,02
6400A-25/32	25/32"	29.5	50	1	15,02
6400A-13/16	13/16"	31	50	1	15,02
6400A-7/8	7/8"	32	50	1	15,02
6400A-15/16	15/16"	34.5	50	1	15,02
6400A-31/32	31/32"	36	50	1	16,03
6400A-1	1"	37	50	1	16,03
6400A-1-1/16	1-1/16"	38.5	53	1	17,05
6400A-1-1/8	1-1/8"	41	53	1	19,58
6400A-1-3/16	1-3/16"	42	55	1	19,58
6400A-1-1/4	1-1/4"	44.5	57	1	19,58
6400A-1-5/16	1-5/16"	46	57	1	23,49
6400A-1-3/8	1-3/8"	48.5	57	1	23,49
6400A-1-7/16	1-7/16"	51	59	1	26,29
6400A-1-1/2	1-1/2"	52	59	1	27,61
6400A-1-9/16	1-9/16"	54.5	59	1	31,43
6400A-1-5/8	1-5/8"	56	62	1	31,43
6400A-1-11/16	1-11/16"	58.5	62	1	35,72
6400A-1-3/4	1-3/4"	59.5	62	1	38,34
6400A-1-13/16	1-13/16"	62	68	1	38,34
6400A-1-7/8	1-7/8"	64.5	68	1	42,05
6400A-1-15/16	1-15/16"	66	68	1	46,75
6400A-2	2"	68.5	68	1	53,85
6400A-2-1/16	2-1/16"	71	72	1	54,29
6400A-2-1/8	2-1/8"	72	72	1	56,27
6400A-2-3/16	2-3/16"	74.5	72	1	58,30
6400A-2-1/4	2-1/4"	76	72	1	58,30
6400A-2-5/16	2-5/16"	78.5	72	1	68,50
6400A-2-3/8	2-3/8"	79.5	76	1	74,39
6400A-2-7/16	2-7/16"	82	76	1	77,52
6400A-2-1/2	2-1/2"	84.5	76	1	77,52
6400A-2-9/16	2-9/16"	86	80	1	88,58
6400A-2-5/8	2-5/8"	88.5	80	1	96,64
6400A-2-11/16	2-11/16"	89.5	80	1	96,64
6400A-2-3/4	2-3/4"	92	84	1	96,64
6400A-2-13/16	2-13/16"	94.5	84	1	96,64
6400A-2-7/8	2-7/8"	96	84	1	96,64
6400A-2-15/16	2-15/16"	98.5	86	1	126,23
6400A-3	3"	101	86	1	126,23
6400A-3-1/8	3-1/8"	104.5	90	1	134,75



POLIGONALE

**CHIAVI A BUSSOLA
A MANO BOCCA
POLIGONALE**

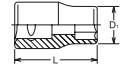

Koken articolo	mm	D mm	L mm		Euro
NEW 6405M-14	14	22.1	50	1	13,94
NEW 6405M-16	16	24.6	50	1	13,94
6405M-17	17	26	50	1	13,94
6405M-18	18	27	50	1	13,94
6405M-19	19	28.5	50	1	13,94
6405M-20	20	29.5	50	1	13,94
6405M-21	21	31	50	1	13,94
6405M-22	22	32	50	1	13,94
6405M-23	23	33.5	50	1	13,94
6405M-24	24	34.5	50	1	13,94
6405M-25	25	36	50	1	14,91
6405M-26	26	37	50	1	14,91
6405M-27	27	38.5	53	1	15,84
6405M-28	28	39.5	53	1	15,84
6405M-29	29	41	53	1	18,18
6405M-30	30	42	55	1	18,18
6405M-31	31	43.5	55	1	18,18
6405M-32	32	44.5	57	1	18,18
6405M-33	33	46	57	1	21,84
6405M-34	34	47	57	1	21,84
6405M-35	35	48.5	57	1	21,84
6405M-36	36	49.5	59	1	24,39
6405M-37	37	51	59	1	24,39
6405M-38	38	52	59	1	25,66
6405M-39	39	53.5	59	1	28,49
6405M-40	40	54.5	59	1	29,15
6405M-41	41	56	62	1	29,15
6405M-42	42	57	62	1	31,35
6405M-43	43	58.5	62	1	33,14
6405M-44	44	59.5	62	1	35,59
6405M-45	45	61	62	1	35,59
6405M-46	46	62	68	1	35,59
6405M-47	47	63.5	68	1	38,97
6405M-48	48	64.5	68	1	38,97
6405M-50	50	67	68	1	43,37
6405M-52	52	69.5	72	1	50,88
6405M-54	54	72	72	1	52,20
6405M-55	55	73.5	72	1	52,20
6405M-56	56	74.5	72	1	54,09
6405M-57	57	76	72	1	54,09
6405M-58	58	77	72	1	57,56
6405M-60	60	79.5	76	1	69,03
6405M-63	63	83.5	76	1	71,91
6405M-65	65	86	80	1	82,25
6405M-70	70	92	84	1	89,65
6405M-75	75	98.5	86	1	117,15
NEW 6405M-78	78	102.1	86	1	125,02
6405M-80	80	104.5	90	1	125,04
6405M-85	85	111	90	1	136,59

CHIAVE A BUSSOLA PER DADI MOZZI RUOTE

FEINTEC articolo	mm	D mm	L mm		Euro
6400M-36R	36	46	59	1	39,50





CHIAVE A BUSSOLA PER DADI MOZZI RUOTE

FEINTEC articolo	mm	D mm	L mm		Euro
6405M-36R	36	46	59	1	39,50

KOKEN 3/4"

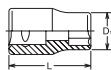
POLLICI



POLIGONALE

**CHIAVI A BUSSOLA
A MANO BOCCA
POLIGONALE**

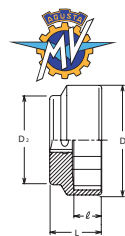

Koken articolo	 pollici	D mm	L mm		Euro
6400A-5/8	5/8"	24.6	50	1	15,02
6405A-11/16	11/16"	27	50	1	15,02
6405A-3/4	3/4"	28.5	50	1	15,02
6405A-25/32	25/32"	29.5	50	1	15,02
6405A-13/16	13/16"	31	50	1	15,02
6405A-7/8	7/8"	32	50	1	15,02
6405A-15/16	15/16"	34.5	50	1	15,02
6405A-31/32	31/32"	36	50	1	16,03
6405A-1	1"	37	50	1	16,03
6405A-1-1/16	1-1/16"	38.5	53	1	17,05
6405A-1-1/8	1-1/8"	41	53	1	19,58
6405A-1-3/16	1-3/16"	42	55	1	19,58
6405A-1-1/4	1-1/4"	44.5	57	1	19,58
6405A-1-5/16	1-5/16"	46	57	1	23,49
6405A-1-3/8	1-3/8"	48.5	57	1	23,49
6405A-1-7/16	1-7/16"	51	59	1	26,29
6405A-1-1/2	1-1/2"	52	59	1	27,61
6405A-1-9/16	1-9/16"	54.5	59	1	31,43
6405A-1-5/8	1-5/8"	56	62	1	31,43
6405A-1-11/16	1-11/16"	58.5	62	1	35,72
6405A-1-3/4	1-3/4"	59.5	62	1	38,34
6405A-1-13/16	1-13/16"	62	68	1	38,34
6405A-1-7/8	1-7/8"	64.5	68	1	42,05
6405A-1-15/16	1-15/16"	66	68	1	46,75
6405A-2	2"	68.5	68	1	53,85
6405A-2-1/16	2-1/16"	71	72	1	54,29
6405A-2-1/8	2-1/8"	72	72	1	56,27
6405A-2-3/16	2-3/16"	74.5	72	1	58,30
6405A-2-1/4	2-1/4"	76	72	1	58,30
6405A-2-5/16	2-5/16"	78.5	72	1	68,50
6405A-2-3/8	2-3/8"	79.5	76	1	74,39
6405A-2-7/16	2-7/16"	82	76	1	77,52
6405A-2-1/2	2-1/2"	84.5	76	1	77,52
6405A-2-9/16	2-9/16"	86	80	1	88,58
6405A-2-5/8	2-5/8"	88.5	80	1	96,64
6405A-2-11/16	2-11/16"	89.5	80	1	96,64
6405A-2-3/4	2-3/4"	92	84	1	96,64
6405A-2-13/16	2-13/16"	94.5	84	1	96,64
6405A-2-7/8	2-7/8"	96	84	1	96,64
6405A-2-15/16	2-15/16"	98.5	86	1	126,23
6405A-3	3"	101	86	1	126,23
6405A-3-1/8	3-1/8"	104.5	90	1	134,75

NEW

3/4"



POLIGONALE

**CHIAVI A BUSSOLA A
MANO BOCCA POLIGONALE
EXTRA CORTE PER DADO
ASSE POSTERIORE MOTO**

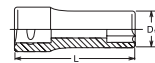

Koken articolo	 pollici	D ₁ mm	L mm		Euro
6405A-MV-2-3/16	2-3/16"	74.6	52	1	79,37



ESAGONO
**CHIAVI A BUSSOLA
A MANO BOCCA
ESAGONALE LUNGHE**

Koken articolo	 mm	D mm	L mm		Euro
6300M-17	17	26	90	1	28,74
6300M-18	18	27	90	1	28,74
6300M-19	19	28.5	90	1	28,74
6300M-20	20	29.5	90	1	28,74
6300M-21	21	31	90	1	28,74
6300M-22	22	32	90	1	28,74
6300M-23	23	33.5	90	1	28,74
6300M-24	24	34.5	90	1	31,24
6300M-25	25	36	90	1	31,24
6300M-26	26	37	90	1	31,24
6300M-27	27	38.5	90	1	31,57
6300M-28	28	39.5	90	1	32,23
6300M-29	29	41	90	1	36,47
6300M-30	30	42	90	1	36,47
6300M-31	31	43.5	90	1	36,47
6300M-32	32	44.5	90	1	36,47
6300M-33	33	46	90	1	41,80
6300M-34	34	47	90	1	41,80
6300M-35	35	48.5	90	1	41,80
6300M-36	36	49.5	90	1	45,24
6300M-38	38	52	90	1	46,56
6300M-40	40	54.5	90	1	52,83
6300M-41	41	56	90	1	52,83
6300M-42	42	57	90	1	63,28
6300M-44	44	59.5	90	1	64,05
6300M-46	46	62	90	1	64,05
6300M-48	48	64.5	90	1	64,65
6300M-50	50	67	90	1	67,05
6300M-52	52	69.5	100	1	67,98
6300M-53	53	71	100	1	70,95
6300M-54	54	72	100	1	96,25
6300M-55	55	73.5	100	1	96,25
6300M-56	56	74.5	100	1	98,51
6300M-57	57	76	100	1	102,66
6300M-58	58	77	100	1	106,29
6300M-60	60	79.5	100	1	127,96
6300M-63	63	83.5	100	1	131,97
6300M-65	65	86	100	1	145,83

**PER DADI →
MOZZI RUOTE**
**CHIAVE A BUSSOLA
PER DADI MOZZI RUOTE**

FEMEC articolo	 mm	D mm	L mm		Euro
6300M-36R	36	46	90	1	55,00



POLLICI



**CHIAVI A BUSSOLA
A MANO BOCCA
ESAGONALE LUNGHE**

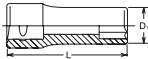

Koken articolo	pollici	D mm	L mm		Euro
6300A-3/4	3/4"	28.5	90	1	30,99
6300A-25/32	25/32"	29.5	90	1	30,99
6300A-13/16	13/16"	31	90	1	30,99
6300A-7/8	7/8"	32	90	1	30,99
6300A-15/16	15/16"	34.5	90	1	33,69
6300A-1	1"	37	90	1	33,69
6300A-1-1/16	1-1/16"	38.5	90	1	33,99
6300A-1-1/8	1-1/8"	41	90	1	35,89
6300A-1-3/16	1-3/16"	42	90	1	39,30
6300A-1-1/4	1-1/4"	44.5	90	1	39,30
6300A-1-5/16	1-5/16"	46	90	1	45,05
6300A-1-3/8	1-3/8"	48.5	90	1	45,05
6300A-1-7/16	1-7/16"	51	90	1	50,13
6300A-1-1/2	1-1/2"	52	90	1	50,13
6300A-1-9/16	1-9/16"	54.5	90	1	56,95
6300A-1-5/8	1-5/8"	56	90	1	56,95
6300A-1-11/16	1-11/16"	58.5	90	1	69,03
6300A-1-3/4	1-3/4"	59.5	90	1	69,03
6300A-1-13/16	1-13/16"	62	90	1	69,03
6300A-2	2"	68.5	90	1	72,24
6300A-2-1/16	2-1/16"	71	100	1	76,45
6300A-2-1/8	2-1/8"	72	100	1	103,70
6300A-2-3/16	2-3/16"	74.5	100	1	106,15
6300A-2-1/4	2-1/4"	76	100	1	110,66
6300A-2-5/16	2-5/16"	78.5	100	1	114,54
6300A-2-3/8	2-3/8"	79.5	100	1	137,89
6300A-2-7/16	2-7/16"	82	100	1	142,20



**CHIAVI A BUSSOLA
A MANO BOCCA
POLIGONALE LUNGHE**

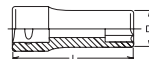

Koken articolo	mm	D mm	L mm		Euro
6305M-17	17	26	90	1	28,74
6305M-18	18	27	90	1	28,74
6305M-19	19	28.5	90	1	28,74
6305M-20	20	29.5	90	1	28,74
6305M-21	21	31	90	1	28,74
6305M-22	22	32	90	1	28,74
6305M-23	23	33.5	90	1	28,74
6305M-24	24	34.5	90	1	31,24
6305M-25	25	36	90	1	31,24
6305M-26	26	37	90	1	31,24
6305M-27	27	38.5	90	1	31,57
6305M-28	28	39.5	90	1	32,23
6305M-29	29	41	90	1	36,47
6305M-30	30	42	90	1	36,47
6305M-31	31	43.5	90	1	36,47
6305M-32	32	44.5	90	1	36,47
6305M-33	33	46	90	1	41,80
6305M-34	34	47	90	1	41,80
6305M-35	35	48.5	90	1	41,80
6305M-36	36	49.5	90	1	45,24
6305M-38	38	52	90	1	46,56
6305M-40	40	54.5	90	1	52,83
6305M-41	41	56	90	1	52,83
6305M-42	42	57	90	1	63,28
6305M-44	44	59.5	90	1	64,05
6305M-46	46	62	90	1	64,05
6305M-48	48	64.5	90	1	64,65
6305M-50	50	67	90	1	67,05
6305M-52	52	69.5	100	1	67,98
6305M-53	53	71	100	1	70,95
6305M-54	54	72	100	1	96,25
6305M-55	55	73.5	100	1	96,25
6305M-56	56	74.5	100	1	98,51
6305M-57	57	76	100	1	102,66
6305M-58	58	77	100	1	106,29
6305M-60	60	79.5	100	1	127,96
6305M-63	63	83.5	100	1	131,97
NEW 6305M-65	65	86	100	1	145,83

POLLICI



**CHIAVI A BUSSOLA
A MANO BOCCA
POLIGONALE LUNGHE**



Koken articolo	pollici	D mm	L mm		Euro
6305A-3/4	3/4"	28.5	90	1	30,99
6305A-25/32	25/32"	29.5	90	1	30,99
6305A-13/16	13/16"	31	90	1	30,99
6305A-7/8	7/8"	32	90	1	30,99
6305A-15/16	15/16"	34.5	90	1	33,69
6305A-1	1"	37	90	1	33,69
6305A-1-1/16	1-1/16"	38.5	90	1	33,99
6305A-1-1/8	1-1/8"	41	90	1	35,89
6305A-1-3/16	1-3/16"	42	90	1	39,30
6305A-1-1/4	1-1/4"	44.5	90	1	39,30
6305A-1-5/16	1-5/16"	46	90	1	45,05
6305A-1-3/8	1-3/8"	48.5	90	1	45,05
6305A-1-7/16	1-7/16"	51	90	1	50,13
6305A-1-1/2	1-1/2"	52	90	1	50,13
6305A-1-9/16	1-9/16"	54.5	90	1	56,95
6305A-1-5/8	1-5/8"	56	90	1	56,95
6305A-1-11/16	1-11/16"	58.5	90	1	69,03
6305A-1-3/4	1-3/4"	59.5	90	1	69,03
6305A-1-13/16	1-13/16"	62	90	1	69,03
6305A-2	2"	68.5	90	1	72,24
6305A-2-1/16	2-1/16"	71	100	1	76,45
6305A-2-1/8	2-1/8"	72	100	1	103,70
6305A-2-3/16	2-3/16"	74.5	100	1	106,15
6305A-2-1/4	2-1/4"	76	100	1	110,66
6305A-2-5/16	2-5/16"	78.5	100	1	114,54
6305A-2-3/8	2-3/8"	79.5	100	1	137,89
6305A-2-7/16	2-7/16"	82	100	1	142,20



**CHIAVI A BUSSOLA
A TAGLIO**

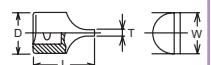

Koken articolo	mm	D mm	L mm		Euro
6101K	6,4x33,5	35	50	1	41,66





**CHIAVE A BUSSOLA
PER DADI MOZZI RUOTE**

FEINIC articolo	mm	D mm	L mm		Euro
6305M-36R	36	46	90	1	55,00

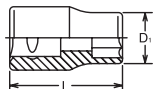

KOKEN 3/4"

**CHIAVI A BUSSOLA A
MANO BOCCA
TORX®**

Koken articolo		D ₁ mm	L mm		Euro
6425-E18	E18	22.1	50	1	24,78
6425-E20	E20	24.6	50	1	24,78
6425-E22	E22	27.1	50	1	24,78
6425-E24	E24	28.6	50	1	24,78
6425-E26	E26	31.1	55	1	26,02
6425-E28	E28	32.1	60	1	26,02
6425-E30	E30	35.0	60	1	26,29
6425-E32	E32	36.1	60	1	26,29

TORX®



	S mm		S mm
E 4	3.70	E 16	14.60
E 5	4.60	E 18	16.50
E 6	5.60	E 20	18.30
E 7	6.10	E 22	20.10
E 8	7.40	E 24	22.00
E 10	9.30	E 26	23.70
E 11	9.90	E 28	25.50
E 12	11.00	E 30	27.30
E 14	12.80	E 32	29.00



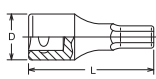

	S mm		S mm
E 4	3.70	E 16	14.60
E 5	4.60	E 18	16.50
E 6	5.60	E 20	18.30
E 7	6.10	E 22	20.10
E 8	7.40	E 24	22.00
E 10	9.30	E 26	23.70
E 11	9.90	E 28	25.50
E 12	11.00	E 30	27.30
E 14	12.80	E 32	29.00



PER USO A MANO
**CHIAVI A BUSSOLA
MASCHIO ESAGONALE
INTEGRALE**

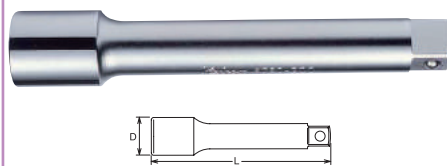

Koken articolo		D mm	L mm		Euro
6012M-12	12	35	75	1	22,88
6012M-14	14	35	75	1	22,88
6012M-15	15	35	75	1	22,88
6012M-16	16	35	75	1	22,88
6012M-17	17	35	75	1	22,88
6012M-18	18	35	75	1	22,88
6012M-19	19	35	75	1	22,88
6012M-20	20	35	75	1	25,49
6012M-21	21	38	75	1	26,02
6012M-22	22	38	75	1	26,02
6012M-24	24	38	75	1	26,02
6012M-27	27	38	75	1	26,02
6012M-30	30	38	75	1	48,70
6012M-32	32	38	75	1	49,20
6012M-36	36	42	75	1	49,20

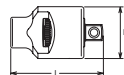

PROLUNGHE CON ATTACCO QUADRO

Koken articolo	D mm	L mm		Euro
6760-75	35	75	1	22,47
6760-100	35	100	1	28,38
6760-125	35	125	1	32,18
6760-150	35	150	1	31,82
6760-200	35	200	1	31,82
6760-300	35	300	1	48,70
6760-400	35	400	1	48,70



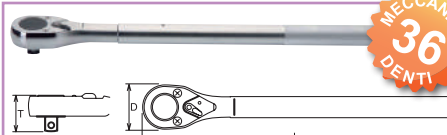

**ADATTATORE A
CRICCHETTO**

Koken articolo	D mm	L mm		Euro
6755	62	97	1	142,48

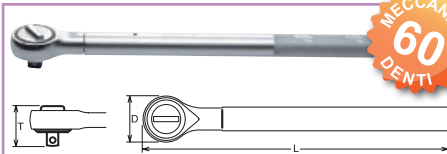

CRICCHETTO PORTABUSSOLA REVERSIBILE

Koken articolo	D mm	T mm	L mm		Euro
6749	68	49,6	565	1	158,59
6749-1000	68	49,6	1000	1	226,63



CRICCHETTO PORTABUSSOLA REVERSIBILE

Koken articolo	D mm	T mm	L mm		Euro
6752	67	55,5	500	1	191,70

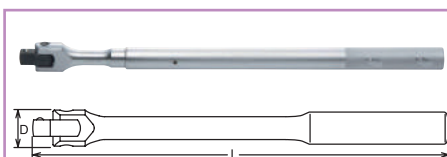

QUADRO MASCHIO SNODATO IN 2 PEZZI

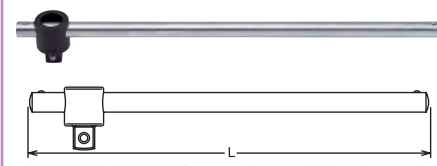
Koken articolo	D mm	L mm		Euro
6768-450	42	450	1	95,26
6768-600	42	600	1	119,08
6768-1000	42	1000	1	183,81



L'innovativa barra a forma ovale offre una maggiore durata e impedisce al quadro scorrevole di ruotare attorno l'asta.

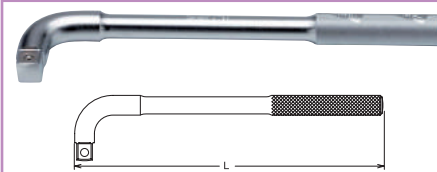

QUADRO MASCHIO CON ASTA SCORREVOLE

Koken articolo	L mm		Euro
6785	500	1	52,53

QUADRO MASCHIO AD ANGOLO

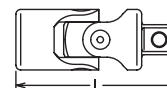
Koken articolo	L mm		Euro
6788	330	1	55,39



Koken articolo	L mm		Euro
6770	105	1	50,27





**RACCORDO DI RIDUZIONE
QUADRO MASCHIO 1/2" E FEMMINA 3/4"**

Koken articolo	L mm		Euro
6644A	47	1	18,04

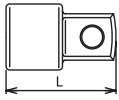

**RACCORDO DI RIDUZIONE
QUADRO MASCHIO 1" E FEMMINA 3/4"**

Koken articolo	L mm		Euro
6688A	60	1	24,26



Koken articolo	DESCRIZIONE	Euro
6201M-00	Cassetta metallica 16 Pz. 580 x 200 x h 85 mm	739,17

RICAMBI

BUSSOLE	ESAGONO	6400M	22, 24, 27, 30, 32, 36, 41, 46, 50, 55, 60
		6749	
		6760-200	
ACCESSORI		6760-400	
		6768	
		6785	

POLLICI



Koken articolo	DESCRIZIONE	Euro
6201A-00	Cassetta metallica 18 Pz. 580 x 200 x h 85 mm	760,38

RICAMBI

BUSSOLE	ESAGONO	6400A	7/8, 15/16, 1-1/16, 1-1/8, 1-1/4, 1-5/16, 1-7/16, 1-1/2, 1-5/8, 1-11/16, 1-13/16, 1-7/8, 2
		6749	
		6760-200	
ACCESSORI		6760-400	
		6768	
		6785	

POLLICI



Koken articolo	DESCRIZIONE	Euro
6201A-05	Cassetta metallica 16 Pz. 580 x 200 x h 85 mm	760,38

RICAMBI

BUSSOLE	POLIGONALE	6405A	7/8, 15/16, 1-1/16, 1-1/8, 1-1/4, 1-5/16, 1-7/16, 1-1/2, 1-5/8, 1-11/16, 1-13/16, 1-7/8, 2
		6749	
		6760-200	
ACCESSORI		6760-400	
		6768	
		6785	



Koken articolo	DESCRIZIONE	Euro
6212M-00	Cassetta metallica 16 Pz. 580 x 124 x h 70 mm	479,96

RICAMBI

BUSSOLE	ESAGONO	6400M	22, 24, 27, 30, 32, 36, 41, 46, 50
		6749	
ACCESSORI		6760-200	
		6785	



Koken articolo	DESCRIZIONE	Euro
6212M-05	Cassetta metallica 16 Pz. 580 x 124 x h 70 mm	479,96

RICAMBI

BUSSOLE	POLIGONALE	6405M	22, 24, 27, 30, 32, 36, 41, 46, 50
		6749	
ACCESSORI		6760-200	
		6785	



Koken articolo	DESCRIZIONE	Euro
6201M-05	Cassetta metallica 16 Pz. 580 x 200 x h 85 mm	739,17

RICAMBI

BUSSOLE	POLIGONALE	6405M	22, 24, 27, 30, 32, 36, 41, 46, 50, 55, 60
		6749	
		6760-200	
ACCESSORI		6760-400	
		6768	
		6785	





BUSSOLE CHROM-VANADIUM CON FORO NEL QUADRO

Attacco: 3/4"
impronta: ESAGONO

BGS articolo	mm	L mm		Euro
BGS 3419	19	50	1	8,16
BGS 3421	21	50	1	8,16
BGS 3422	22	50	1	8,16
BGS 3423	23	50	1	8,67
BGS 3424	24	50	1	8,67
BGS 3426	26	50	1	8,67
BGS 3427	27	50	1	8,67
BGS 3430	30	55	1	9,56
BGS 3432	32	55	1	11,09
BGS 3433	33	55	1	11,73
BGS 3434	34	55	1	12,62
BGS 3435	35	55	1	13,01
BGS 3436	36	60	1	13,26
BGS 3438	38	60	1	17,60
BGS 3441	41	65	1	17,60
BGS 3442	42	65	1	18,36
BGS 3444	44	65	1	22,19
BGS 3446	46	70	1	19,64
BGS 3448	48	70	1	20,27
BGS 3450	50	70	1	20,91
BGS 3455	55	70	1	31,88
BGS 1207-60 NEW	60	80	1	36,98



BUSSOLE CHROM-VANADIUM POLIGONALI CON FORO NEL QUADRO

Attacco: 3/4"
impronta: POLIGONALI

BGS articolo	mm	L mm		Euro
BGS 7419	19	50	1	7,91
BGS 7421	21	50	1	7,91
BGS 7422	22	50	1	7,91
BGS 7424	24	50	1	7,91
BGS 7427	27	50	1	8,93
BGS 7430	30	55	1	10,20
BGS 7432	32	55	1	11,22
BGS 7434	34	55	1	14,54
BGS 7436	36	60	1	14,66
BGS 7438	38	60	1	15,05
BGS 7441	41	65	1	17,60
BGS 7446	46	70	1	19,64
BGS 7450	50	70	1	21,68



CHIAVI A BUSSOLA MASCHIO ESAGONALI

BGS articolo	mm	L mm		Euro
BGS 5189-H14	14	85	1	22,95
BGS 5189-H17	17	85	1	24,23
BGS 5189-H19	19	85	1	25,50
BGS 5189-H22	22	85	1	26,78

CARATTERISTICHE

- finitura satinata cromata
- zigrinate



CHIAVI A BUSSOLA MASCHIO TORX

BGS articolo		L mm		Euro
BGS 5189-T60	TX 60	80	1	21,68
BGS 5189-T70	TX 70	80	1	22,95
BGS 5189-T80	TX 80	80	1	24,23
BGS 5189-T90	TX 90	80	1	25,50
BGS 5189-T100	TX 100	80	1	26,78

CARATTERISTICHE

- finitura satinata cromata
- zigrinate



SET 9 PEZZI, BUSSOLE ATT. 3/4", ESAGONALI E TORX

BGS articolo	DESCRIZIONE	Euro
BGS 5189	SET 9 PEZZI, BUSSOLE ATT. 3/4", ESAGONALI E TORX	187,38

CARATTERISTICHE

- comprende:
 - bussole Esagonali, lunghezza 85 mm: 14 - 17 - 19 - 22 mm
 - bussole Torx, lunghezza 80 mm: TX60 - TX70 - TX80 - TX90 - TX100
- zigrinate
- finitura satinata cromata

TORX®	S mm	S mm	
T 6	1.70	T 40	6.70
T 7	2.00	T 45	7.90
T 8	2.30	T 50	8.90
T 9	2.50	T 55	11.30
T 10	2.70	T 60	13.30
T 15	3.30	T 70	15.60
T 20	3.90	T 80	17.60
T 25	4.50	T 90	20.00
T 27	5.00	T 100	22.20
T 30	5.60		



BGS articolo	DESCRIZIONE	Euro
BGS 231	CRICCHETTO REVERSIBILE	70,13

CARATTERISTICHE

- con impugnatura zigrinata
- lunghezza 500 mm



BGS articolo	DESCRIZIONE	Euro
BGS 232	CHIAVE A CRICCHETTO A 2 ELEMENTI, CON LEVA E PULSANTE DI SGANCIO RAPIDO EXTRA LUNGA	95,63

CARATTERISTICHE

- da set BGS 1207
- lunghezza 500 mm
- con pulsante di sgancio rapido

BGS articolo	DESCRIZIONE	Euro
BGS 232-REPAIR	KIT DI RIPARAZIONE	42,59



NEW



CV **3/4"** **PRO+**

BGS articolo	DESCRIZIONE	Euro
BGS 9765	CHIAVE A CRICCHETTO REVERSIBILE, ATT. 3/4", LUNGHEZZA 550 MM	80,33

CARATTERISTICHE

- con pulsante di sgancio rapido
- lunghezza 550 mm
- meccanismo a cricchetto con 24 denti



3/4"

LEVA CON QUADRO SCORREVOLE CROMATA

Attacco: 3/4"

BGS articolo	L mm	Euro
BGS 263	450	31,62



LEVA CON QUADRO SCORREVOLE "POWER IMPACT" BRUNITA

Attacco: 3/4"

BGS articolo	L mm	Euro
BGS 754050	510	50,40



3/4" **PRO+** **CV**

BGS articolo	DESCRIZIONE	Euro
BGS 263-1	ADATTATORE SCORREVOLE PER BARRE ATT. 3/4"	19,00

CARATTERISTICHE

- cromata, satinata
- per impiego con prolunghe



ADATTATORI DOPPIO QUADRO MASCHIO

BGS articolo	L mm	Euro
2841	20	4,00
3841	30	5,00
4841	37	6,00
BGS 9623 NEW	53	9,69

CARATTERISTICHE

- con doppia sfera

NEW



PRO+ **CV** **3/4"**

BGS articolo	DESCRIZIONE	Euro
BGS 213	CHIAVE A CRICCHETTO ESTENSIBILE, 600 - 985 MM, ATTACCO 3/4"	166,25

CARATTERISTICHE

- in acciaio forgiato
- con manico extra largo
- coppia max: 1400 Nm
- **lunghezza regolabile** in 8 step: 600 - 655 - 710 - 765 - 815 - 875 - 925 - 985 mm

BGS 283-1



3/4" **PRO+** **CV**

BGS articolo	DESCRIZIONE	Euro
BGS 283	IMPUGNATURA SNODATA, LUNGH. 630 MM - ATT. 3/4"	47,69

CARATTERISTICHE

- cromata
- testa quadro, nera
- coppia massima 600 Nm

RICAMBI

BGS articolo	DESCRIZIONE	Euro
BGS 283-1	KIT RIPARAZIONE	22,00



CRICCHETTO REVERSIBILE CON QUADRO FEMMINA PASSANTE

BGS articolo	L mm	Euro
BGS 9160 NEW	115	23,14
3940	260	28,00
BGS 312	270	38,00
5840	450	60,00
BGS 9622 NEW	500	123,68

BGS articolo	L mm	Euro
6040	250	30,00
6340	250	38,00
6540	250	38,00
6640	250	38,00

CARATTERISTICHE

- quadro passante
- impugnatura rivestita



3/4" **3/4"**

PROLUNGHE

attacco: 3/4"

BGS articolo	L mm	Euro
BGS 264	100	16,07
BGS 266	200	21,42
BGS 268	400	31,62

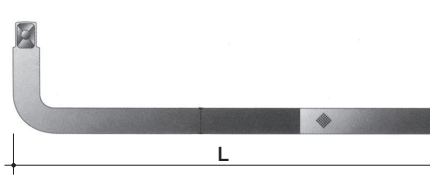

QUADRO MASCHIO AD ANGOLO "POWER IMPACT" BRUNITO

Attacco: 3/4"

BGS articolo	L mm	Euro
BGS 764050	450	47,25

3/4"



3/4" ESAGONO

PRO+

BGS articolo	DESCRIZIONE	Euro
BGS 1457	CHIAVE A CROCE PER RUOTE DI AUTOCARRI	60,69

CARATTERISTICHE

- esagono 24, 27, 32 mm, quadro maschio 3/4"
- finitura cromata
- con estremità lucidate
- lunghezza braccio 70 cm
- coppia massima:
 - 24 mm (450 Nm)
 - 27 mm (590 Nm)
 - 32 mm (880 Nm)
 - 3/4" (890 nm)



3/4" ESAGONO

PRO+

BGS articolo	DESCRIZIONE	Euro
BGS 1458	CHIAVE A CROCE PER RUOTE DI AUTOCARRI, RIPIEGABILE, GIUNTO ARTICOLATO	148,75

CARATTERISTICHE

- esagono 24, 27, 32 mm, quadro maschio 3/4"
- lunghezza braccio circa 600 cm
- maggiore coppia grazie al giunto regolabile



3/4"

PRO+ CV

CHIAVI APERTE A ZAMPA DI GALLO

attacco: 3/4"

BGS articolo	mm	1	Euro
BGS 1759-38	38	1	29,71
BGS 1759-41	41	1	30,60
BGS 1759-46	46	1	34,43
BGS 1759-50	50	1	38,25



1/2" 3/4" PRO+ CV

SET 7 PZ CHIAVI APERTE A ZAMPA DI GALLO

- 30, 36 MM QUADRO 1/2"
- 38, 41, 46 MM QUADRO 3/4"
- N. 1 PROLUNGA 1/2" L. 125 MM
- N. 1 PROLUNGA 3/4" L. 100 MM

attacco: 1/2" - 3/4"

BGS articolo	Descrizione	1	Euro
BGS 1759	SET 7 CHIAVI	1	258,75



3/4"

ESAGONO

PRO+

BGS articolo	DESCRIZIONE	Euro
BGS 1206	SET 14 PEZZI, BUSSOLE ATT. 3/4"	299,88

CARATTERISTICHE

- forgiate
- 10 bussole esagonali 22-24-27-30-32-36-38-41-46-50 mm
- 1 chiave a cricchetto reversibile 500 mm
- 1 barra scorrevole a T 450 mm
- 2 prolunghe 100 - 200 mm
- finitura cromata satinata

RICAMBI

BGS articolo	DESCRIZIONE	Euro
BGS 1206-LEER	CASSETTA VUOTA	75,23



3/4"

ESAGONO

CV



BGS articolo	DESCRIZIONE	Euro
BGS 15113	SET 20 PEZZI, BUSSOLE ATT. 3/4"	259,74

CARATTERISTICHE

- comprende i seguenti utensili con attacco 3/4":
 - cricchetto reversibile, lunghezza 495 mm
 - leva con quadro scorrevole, lunghezza 450 mm
 - 2 prolunghe, lunghezza: 100 e 200 mm
 - 16 bussole esagonali misure: 19 - 21 - 22 - 23 - 24 - 26 - 27 - 30 - 32 - 34 - 36 - 38 - 41 - 46 - 48 - 50 mm
- materiale: cromo vanadio, forgiato, finitura satinata cromata
- in cassetta metallica



3/4" **CV** **PRO+** **ESAGONO**

BGS articolo	DESCRIZIONE	Euro
BGS 1207	SET 21 PEZZI, BUSSOLE ESAGONALI ATT. 3/4"	391,25

CARATTERISTICHE

- conforme DIN
- bussole esagonali
- 16 bussole: 19-21-22-23-24-26-27-30-32-34-36-38-41-46-48-50 mm,
- 1 cricchetto reversibile lunghezza 500 mm con pulsante di sgancio rapido, testa finitura nera
- 3 prolunghe: 100 - 200 - 400 mm
- 1 chiave con "T" con quadro scorrevole lunghezza 450 mm

RICAMBI

BGS articolo	DESCRIZIONE	Euro
BGS 1207-LEER	CASSETTA VUOTA	67,58

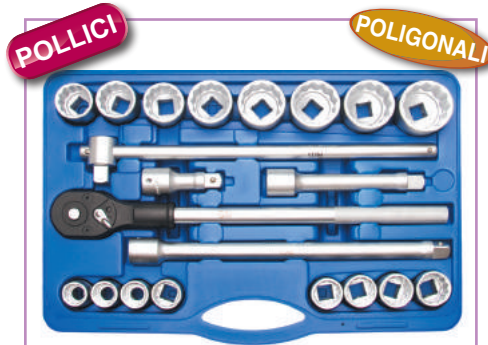

POLLICI **POLIGONALI**
3/4" **POLIGONALE** **CV** **PRO+**

BGS articolo	DESCRIZIONE	Euro
BGS 1107	SET 21 PEZZI, BUSSOLE ATT. 3/4"	383,75

CARATTERISTICHE

- conforme DIN
- bussole poligonali: 7/8", 15/16", 1", 1 1/16", 1 1/8", 1 3/16", 1 1/4", 1 5/16", 1 3/8", 1 7/16", 1 1/2", 1 5/8", 1 3/4", 1 13/16", 1 7/8", 2"
- 1 chiave a cricchetto reversibile 500 mm con pulsante di sgancio rapido, testa con finitura nera
- 3 barre di prolunga 100 - 200 - 400 mm
- 1 barra scorrevole a T 450 mm



3/4" **ESAGONO** **PRO+**

BGS articolo	DESCRIZIONE	Euro
BGS 1202	SET 20 PEZZI, BUSSOLE ATT. 3/4"	188,50

CARATTERISTICHE

- forgiate
- 16 bussole con esagono: 19-21-22-23-24-26-27-30-32-34-36-38-41-46-48-50 mm
- 1 chiave a cricchetto reversibile 500 mm
- 1 barra scorrevole a T 450 mm
- 2 barre di prolunga 100-200 mm
- finitura satinata cromata

RICAMBI

BGS articolo	DESCRIZIONE	Euro
BGS 1202-LEER	CASSETTA VUOTA	19,38



3/4" **PRO+** **CV** **POLIGONALE**

BGS articolo	DESCRIZIONE	Euro
BGS 1223	SET 21 PEZZI, BUSSOLE POLIGONALI ATT. 3/4"	397,38

CARATTERISTICHE

- contenuto:
 - bussole poligonali: 19 - 21 - 22 - 23 - 24 - 26 - 27 - 29 - 30 - 32 - 35 - 36 - 38 - 41 - 46 - 50 mm
 - 3 prolunghe lunghezza 100, 200 e 410 mm
 - cricchetto reversibile lunghezza 500 mm
 - asta con quadro scorrevole lunghezza 455 mm



1/4"-3/8"-1/2"-3/4" 1/4"-3/8"-1/2"-3/4"

RACCORDI DI RIDUZIONE CHROM-VANADIUM

attacco: 1/4" - 3/8" - 1/2" - 3/4"

BGS articolo	FEMMINA	MASCHIO	Box	Euro
BGS 271	1/4"	3/8"	1	3,15
BGS 269	3/8"	1/4"	1	3,15
BGS 280	3/8"	1/2"	1	3,68
BGS 270	1/2"	3/8"	1	3,68
BGS 272	1/2"	3/4"	1	8,40
BGS 274	3/4"	1/2"	1	8,40

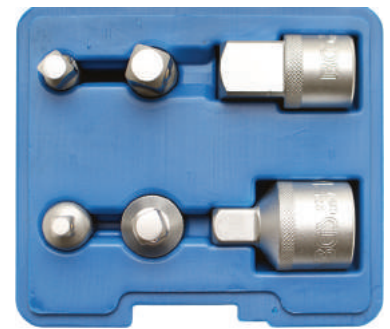

PRO+ **CV**

BGS articolo	DESCRIZIONE	Euro
BGS 199	SET 6 PEZZI ADATTATORI	24,23

CARATTERISTICHE

- cromati satinati

CONTENUTO

- 1/4" F X 3/8" M, coppia massima 60 Nm
- 3/8" F X 1/4" M, coppia massima 60 Nm
- 3/8" F X 1/2" M, coppia massima 200 Nm
- 1/2" F X 3/8" M, coppia massima 200 Nm
- 1/2" F X 3/4" M, coppia massima 500 Nm
- 3/4" F X 1/2" M, coppia massima 500 Nm

RICAMBI

BGS articolo	DESCRIZIONE	Euro
BGS 199-LEER	CASSETTA VUOTA	5,36

NOTE

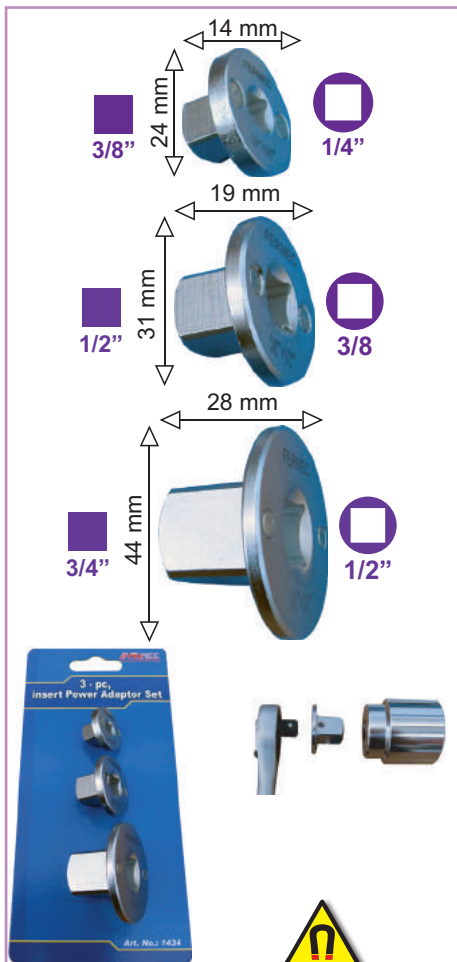

**RACCORDI DI RIDUZIONE MAGNETICI
A SCOMPARSA IDEALI PER CHIAVI
DINAMOMETRICHE E SPAZI RIDOTTI**

attacco: 1/4"-3/8"-1/2"

articolo	FERMEC		Euro
	FEMMINA	MASCHIO	
1434-1/4	1/4"	3/8"	8,93
1434-3/8	3/8"	1/2"	9,98
1434-1/2	1/2"	3/4"	11,03
1434	SET DA 3 PEZZI IN BLISTER		28,35

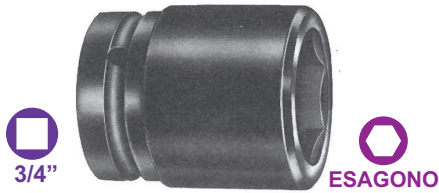
BUSSOLE "POWER IMPACT"

 attacco: 3/4"
 impronta: ESAGONO

FEFMEC articolo	mm	L mm		Euro
199-13	13	45	1	18,43
199-14	14	45	1	18,43
199-15	15	51	1	18,43
199-16	16	51	1	18,43
199-17	17	51	1	18,43
199-18	18	51	1	18,43
199-19	19	51	1	18,43
199-20	20	51	1	18,43
199-21	21	51	1	18,43
199-22	22	51	1	18,43
199-23	23	51	1	18,43
199-24	24	51	1	18,43
199-25	25	51	1	18,43
199-26	26	51	1	18,43
199-27	27	57	1	18,43
199-28	28	57	1	19,55
199-29	29	57	1	19,55
199-30	30	57	1	19,55
199-31	31	57	1	20,79
199-32	32	57	1	21,85
199-33	33	57	1	21,85
199-34	34	57	1	23,45
199-35	35	57	1	23,82
199-36	36	57	1	24,05
199-37	37	57	1	24,05
199-38	38	58	1	28,25
199-39	39	58	1	30,38
199-40	40	58	1	30,38
199-41	41	58	1	30,38
199-42	42	58	1	31,63
199-43	43	63	1	33,30
199-44	44	63	1	33,30
199-45	45	63	1	33,30
199-46	46	63	1	34,55
199-47	47	63	1	37,19
199-48	48	67	1	37,19
199-49	49	67	1	41,97
199-50	50	67	1	42,00
199-52	52	70	1	52,06
199-54	54	71	1	55,36
199-55	55	71	1	55,36
199-56	56	74	1	57,12
199-57	57	74	1	57,12
199-58	58	75	1	58,01
199-59	59	75	1	58,01
199-60	60	75	1	63,00
199-61	61	75	1	74,73
199-63	63	75	1	80,81
199-65	65	78	1	80,81
199-67	67	80	1	84,03

**CASSETTA METALLICA PEZZI 10
BUSSOLE MACCHINA 3/4"**

17 - 19 - 22 - 24 - 27 - 30 - 32 - 36 - 41 - 46 MM

 attacco: 3/4"
 impronta: ESAGONO

FEFMEC articolo	Descrizione		Euro
199146	CASSETTA METALLICA 10 PEZZI	1	131,25

BUSSOLE "POWER IMPACT" ECONOMICHE

 attacco: 3/4"
 impronta: ESAGONO

BGS articolo	mm	L mm		Euro
BGS 5617	17	51	1	13,26
BGS 5618	18	51	1	13,77
BGS 5619	19	51	1	13,77
BGS 5621	21	51	1	14,03
BGS 5622	22	51	1	14,03
BGS 5624	24	51	1	14,28
BGS 5626	26	51	1	14,54
BGS 5627	27	57	1	14,79
BGS 5630	30	57	1	15,30
BGS 5632	32	57	1	17,09
BGS 5633	33	57	1	17,34
BGS 5634	34	57	1	17,60
BGS 5635	35	57	1	18,11
BGS 5636	36	57	1	18,36
BGS 5638	38	58	1	19,13
BGS 5641	41	58	1	20,91
BGS 5646	46	63	1	27,29
BGS 5648	NEW 48	63	1	28,05
BGS 5650	50	67	1	30,60
BGS 5655	55	71	1	40,80
BGS 5660	60	75	1	50,49



ESAGONO

PRO+

3/4"

BGS articolo	DESCRIZIONE	Euro
BGS 5240	SET 8 PEZZI BUSSOLE A MACCHINA	116,03

CARATTERISTICHE

- per utilizzo a macchina
- con scanalatura e foro per spina
- lunghezza 56 mm
- 22-24-27-28-30-32-36-38 mm



3/4"

PRO+

CROMO

ESAGONO

BGS articolo	DESCRIZIONE	Euro
BGS 5242	CASSETTA 17 BUSSOLE IMPACT, ATTACCO QUADRO 3/4", 19-55 MM	349,88

CARATTERISTICHE

- con scanalatura e foro per spina
- comprende le seguenti misure (Ø max. esterno x lunghezza):
 19 mm (Ø 38 x 51 mm), 21 mm (Ø 40 x 51 mm),
 22 mm (Ø 40 x 51 mm), 24 mm (Ø 40 x 51 mm),
 27 mm (Ø 40 x 54 mm), 30 mm (Ø 46 x 54 mm),
 32 mm (Ø 48 x 57 mm), 33 mm (Ø 50 x 57 mm),
 34 mm (Ø 52 x 57 mm), 35 mm (Ø 52 x 57 mm),
 36 mm (Ø 54 x 57 mm), 38 mm (Ø 56 x 57 mm),
 40 mm (Ø 58 x 57 mm), 41 mm (Ø 60 x 57 mm),
 46 mm (Ø 66 x 63 mm), 50 mm (Ø 71 x 68 mm),
 55 mm (Ø 77 x 73 mm)

IMPACT 3/4"



NEW



LA SOLA CASSETTA DA 29 PEZZI INDISPENSABILE PER CANTIERI



3/4" ESAGONO CROMO

FERMEC

articolo

1992901

DESCRIZIONE

SET 29 PEZZI BUSSOLE A MACCHINA, ATT. 3/4", 19-65 MM

Euro

560,00

CARATTERISTICHE

- comprende le seguenti bussole esagonali:
19-20-21-22-23-24-25-26-27-28-29-30-32-33-34-35-36-38-40-41-42-46-50-52-55-58-60-63-65 mm
- con scanalatura e foro per spina
- in cassetta in plastica di dimensioni:
740 x 420 x 125 mm
- peso totale: 24 kg



3/4"



ESAGONO



PRO+

BGS

articolo

BGS 5258

DESCRIZIONE

SET 21 PEZZI,
BUSSOLE ATT. 3/4"

Euro

497,50

CARATTERISTICHE

- 1 chiave a T con quadro scorrevole lunghezza: 450 mm
- impugnatura chiave a cricchetto a sgancio rapido antiscivolo, 505 mm
- barre di prolunga lunghezza 105 e 250 mm
- snodo 105 mm
- bussola da 3/4", esagonali, con foro per spina e anello: 19, 21, 22, 23, 24, 26, 27, 29, 32, 35, 36, 38, 41, 46 e 50 mm

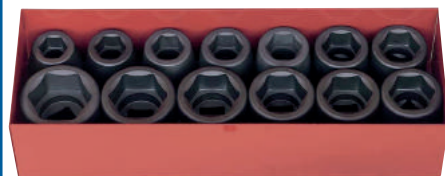

Koken

articolo

16201M-00

DESCRIZIONE

Set chiavi a bussola
13 Pezzi
in cassetta metallica
320 x 110 x h 70 mm

Euro

354,23

RICAMBI

BUSSOLE

ESAGONO

16400M

19, 21, 22, 23, 24,
26, 27, 30, 32, 33,
36, 38, 41



CHIAVI A BUSSOLA
A MACCHINA
BOCCA ESAGONALE

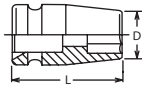

Koken articolo	mm	D mm	L mm	mm	Euro
16400M-16	16	28.8	50	1	23,51
16400M-17	17	30	50	1	23,51
16400M-18	18	31.3	50	1	23,51
16400M-19	19	32.5	50	1	23,51
16400M-20	20	33.8	50	1	23,51
16400M-21	21	35	50	1	23,51
16400M-22	22	36.3	50	1	23,51
16400M-23	23	37.5	50	1	23,51
16400M-24	24	38.8	50	1	23,51
16400M-25	25	40	50	1	23,51
16400M-26	26	41.3	50	1	23,51
16400M-27	27	42.5	50	1	23,51
16400M-28	28	43.8	50	1	24,45
16400M-29	29	45	53	1	24,45
16400M-30	30	46.3	53	1	24,45
16400M-31	31	47.5	53	1	25,36
16400M-32	32	48.8	53	1	25,55
16400M-33	33	50	55	1	28,85
16400M-34	34	51.3	55	1	28,85
16400M-35	35	52.5	55	1	29,43
16400M-36	36	53.8	55	1	29,43
16400M-37	37	55	55	1	33,74
16400M-38	38	56.3	57	1	33,74
16400M-39	39	57.5	57	1	36,99
16400M-40	40	58.8	57	1	36,99
16400M-41	41	60	57	1	36,99
16400M-42	42	61.3	57	1	40,45
16400M-43	43	62.5	62	1	40,45
16400M-44	44	63.8	62	1	40,45
16400M-45	45	65	62	1	41,03
16400M-46	46	66.3	62	1	44,41
16400M-47	47	67.5	62	1	44,72
16400M-48	48	68.8	62	1	44,72
16400M-49	49	70	62	1	45,82
16400M-50	50	71.3	62	1	58,30
16400M-52	52	73.8	62	1	63,75
16400M-54	54	76.3	62	1	67,10
16400M-55	55	77.5	62	1	68,34
16400M-56	56	78.8	62	1	68,34
16400M-57	57	80	65	1	68,75
16400M-58	58	81.3	65	1	69,49
16400M-59	59	82.5	65	1	69,49
16400M-60	60	83.8	65	1	80,22
16400M-65	65	90	65	1	104,03
16400M-70	70	96.3	70	1	118,36

PARETI SOTTILI



CHIAVI A BUSSOLA
A MACCHINA
BOCCA ESAGONALE
PARETI SOTTILI

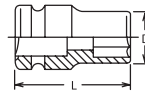

Koken articolo	mm	D mm	L mm	mm	Euro
16401M-17	17	28	50	1	24,15
16401M-18	18	29.3	50	1	24,15
16401M-19	19	30.5	50	1	24,15
16401M-20	20	31.8	50	1	24,15
16401M-21	21	33	50	1	24,15
16401M-22	22	34.3	50	1	24,15
16401M-23	23	35.5	50	1	24,15
16401M-24	24	36.8	50	1	24,15
16401M-25	25	38	50	1	24,15
16401M-26	26	39.3	50	1	24,15
16401M-27	27	40.5	50	1	24,15
16401M-28	28	41.8	50	1	25,11
16401M-29	29	43	53	1	25,11
16401M-30	30	44.3	53	1	25,11
16401M-31	31	45.5	53	1	26,02
16401M-32	32	46.8	53	1	26,24
16401M-33	33	48	55	1	29,59
16401M-34	34	49.3	55	1	29,59
16401M-35	35	50.5	55	1	30,20
16401M-36	36	51.8	55	1	30,20
16401M-37	37	53	55	1	34,65
16401M-38	38	54.3	57	1	34,65
16401M-39	39				35,81
16401M-40	40	56.8	57	1	37,98
16401M-41	41	58	57	1	37,98
16401M-42	42	59.3	57	1	41,50
16401M-43	43	60.5	62	1	41,50
16401M-44	44	61.8	62	1	42,10
16401M-45	45	63	62	1	42,10
16401M-46	46	64.3	62	1	45,60

POLLICI



3/4"

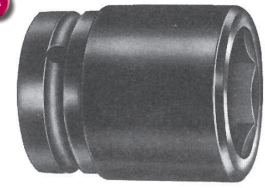

BUSSOLE "POWER IMPACT"

attacco: 3/4"

impronta: ESAGONO

articolo	pollici	L mm	mm	Euro
199-9/16	9/16"	50	1	24,83
199-5/8	5/8"	50	1	24,83
199-11/16	11/16"	50	1	24,83
199-3/4	3/4"	50	1	24,83
199-13/16	13/16"	50	1	24,83
199-7/8	7/8"	50	1	24,83
199-15/16	15/16"	50	1	24,83
199-1	1"	50	1	24,83
199-1-1/8	1-1/8"	50	1	26,19
199-1-1/4	1-1/4"	52	1	27,80
199-1-5/16	1-5/16"	55	1	30,46
199-1-7/16	1-7/16"	55	1	35,64
199-1-1/2	1-1/2"	59	1	35,64
199-1-9/16	1-9/16"	60	1	39,07
199-1-5/8	1-5/8"	60	1	39,07
199-1-11/16	1-11/16"	64	1	42,74
199-1-3/4	1-3/4"	64	1	42,74
199-1-7/8	1-7/8"	67	1	47,30
199-1-15/16	1-15/16"	67	1	50,44
199-2	2"	67	1	61,65
199-2-1/16	2-1/16"	71	1	67,34
199-2-3/16	2-3/16"	74	1	72,19
199-2-5/16	2-5/16"	75	1	73,49
199-2-3/8	2-3/8"	75	1	84,81

IMPACT 3/4"



POLLICI



CHIAVI A BUSSOLA
A MACCHINA
BOCCA ESAGONALE

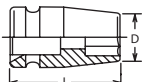

Koken articolo	pollici	D mm	L mm	Euro
16400A-5/8	5/8"	28.8	50	25,30
16400A-11/16	11/16"	30	50	25,30
16400A-3/4	3/4"	32.5	50	25,30
16400A-13/16	13/16"	35	50	25,30
16400A-7/8	7/8"	36.3	50	25,30
16400A-15/16	15/16"	38.8	50	25,30
16400A-1	1"	40	50	25,30
16400A-1-1/16	1-1/16"	42.5	50	25,30
16400A-1-1/8	1-1/8"	45	53	26,32
16400A-1-3/16	1-3/16"	46.3	53	26,32
16400A-1-1/4	1-1/4"	48.8	53	27,56
16400A-1-5/16	1-5/16"	51.3	55	31,05
16400A-1-3/8	1-3/8"	52.5	55	31,68
16400A-1-7/16	1-7/16"	55	55	36,41
16400A-1-1/2	1-1/2"	56.3	57	36,41
16400A-1-9/16	1-9/16"	58.8	57	39,85
16400A-1-5/8	1-5/8"	60	57	39,85
16400A-1-11/16	1-11/16"	62.5	62	43,59
16400A-1-3/4	1-3/4"	65	62	43,59
16400A-1-13/16	1-13/16"	66.3	62	47,88
16400A-1-7/8	1-7/8"	68.8	62	48,21
16400A-1-15/16	1-15/16"	70	62	51,87
16400A-2	2"	71.3	62	62,84
16400A-2-1/16	2-1/16"	73.8	62	68,64
16400A-2-1/8	2-1/8"	76.3	62	72,30
16400A-2-3/16	2-3/16"	77.5	62	73,67
16400A-2-1/4	2-1/4"	80	65	74,11
16400A-2-5/16	2-5/16"	81.3	65	74,91
16400A-2-3/8	2-3/8"	83.8	65	86,43

POLLICI



Koken articolo	DESCRIZIONE	Euro
16201A-00	Set chiavi a bussola 11 Pezzi in cassetta metallica 290 x 124 x h 69 mm	308,96
RICAMBI		
BUSSOLE ESAGONO	16400A 3/4", 7/8", 15/16", 1", 1.1/16", 1.1/8", 1.1/4", 1.5/16", 1.3/8", 1.7/16", 1.1/2"	



POLIGONALI

attacco: 3/4"
impronta: POLIGONALE

articolo	mm	L mm	Euro
199-17 DSKT	17	45	24,20
199-18 DSKT	18	45	24,20
199-19 DSKT	19	45	24,20
199-21 DSKT	21	46	24,20
199-22 DSKT	22	46	24,20
199-24 DSKT	24	46	24,20
199-25 DSKT	25	46	24,20
199-26 DSKT	26	46	24,20
199-27 DSKT	27	48	24,20
199-30 DSKT	30	52	25,53
199-31 DSKT	31	52	27,11
199-32 DSKT	32	52	27,11
199-33 DSKT	33	55	29,68
199-35 DSKT	35	55	30,90
199-36 DSKT	36	56	30,90
199-37 DSKT	37	56	30,90
199-38 DSKT	38	59	34,73
199-39 DSKT	39	59	38,08
199-41 DSKT	41	59	38,08
199-42 DSKT	42	59	41,64
199-43 DSKT	43	64	45,77
199-44 DSKT	44	64	45,77
199-45 DSKT	45	64	45,77
199-46 DSKT	46	64	45,77
199-49 DSKT	49	67	60,09
199-50 DSKT	50	67	60,09
199-52 DSKT	52	70	65,60
199-54 DSKT	54	71	70,34
199-55 DSKT	55	71	70,34
199-57 DSKT	57	75	82,61
199-58 DSKT	58	75	82,61
199-60 DSKT	60	75	82,61
199-61 DSKT	61	75	109,79



CHIAVI A BUSSOLA
A MACCHINA
BOCCA POLIGONALE

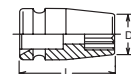

Koken articolo	mm	D mm	L mm	Euro
16405M-17	17	30	50	24,67
16405M-18	18	31.3	50	24,67
16405M-19	19	32.5	50	24,67
16405M-20	20	33.8	50	24,67
16405M-21	21	35	50	24,67
16405M-22	22	36.3	50	24,67
16405M-23	23	37.5	50	24,67
16405M-24	24	38.8	50	24,67
16405M-25	25	40	50	24,67
16405M-26	26	41.3	50	24,67
16405M-27	27	42.5	50	24,67
16405M-28	28	43.8	50	25,66
16405M-29	29	45	53	25,66
16405M-30	30	46.3	53	25,66
16405M-32	32	48.8	53	26,87
16405M-33	33	50	55	30,25
16405M-34	34	51.3	55	30,25
16405M-35	35	53	55	30,88
16405M-36	36	53.8	55	30,88
16405M-38	38	56.3	57	35,48
16405M-41	41	60	57	38,83
16405M-42	42	62.3	57	42,49
16405M-46	46	66.3	62	46,67
16405M-50	50	71.3	62	61,24
16405M-52	52	73.8	62	66,88
16405M-55	55	77.5	62	71,80
16405M-60	60	83.8	65	84,23
16405M-65	65	90	65	109,26





POLLICI



POLIGONALI
attacco: 3/4"
impronta: POLIGONALE

articolo	pollici	L mm	Euro
199-3/4 DSKT	3/4"	45	26,07
199-13/16 DSKT	13/16"	46	26,07
199-7/8 DSKT	7/8"	46	26,07
199-15/16 DSKT	15/16"	46	26,07
199-1 DSKT	1"	46	26,07
199-1-1/8 DSKT	1-1/8"	52	28,82
199-1-1/4 DSKT	1-1/4"	52	36,75
199-1-5/16 DSKT	1-5/16"	55	36,75
199-1-7/16 DSKT	1-7/16"	56	36,75
199-1-9/16 DSKT	1-9/16"	59	46,20
199-1-3/4 DSKT	1-3/4"	64	54,60
199-1-7/8 DSKT	1-7/8"	67	58,80
199-1-15/16 DSKT	1-15/16"	67	67,20
199-2 DSKT	2"	70	71,40
199-2-1/16 DSKT	2-1/16"	71	71,40
199-2-3/16 DSKT	2-3/16"	74	84,00
199-2-5/16 DSKT	2-5/16"	75	92,40
199-2-3/8 DSKT	2-3/8"	75	117,60

POLLICI



CHIAVI A BUSSOLA A MACCHINA BOCCA POLIGONALE

articolo	pollici	D mm	L mm	Euro
16405A-3/4	3/4"	32.5	50	26,59
16405A-13/16	13/16"	35	50	26,59
16405A-7/8	7/8"	36.3	50	26,59
16405A-15/16	15/16"	38.8	50	26,59
16405A-1	1"	40	50	26,59
16405A-1-1/16	1-1/16"	42.5	50	26,59
16405A-1-1/8	1-1/8"	45	53	28,57
16405A-1-3/16	1-3/16"	46.3	53	28,57
16405A-1-1/4	1-1/4"	48.8	53	28,96
16405A-1-5/16	1-5/16"	51.3	55	32,67
16405A-1-3/8	1-3/8"	52.5	55	33,30
16405A-1-7/16	1-7/16"	55	55	38,23
16405A-1-1/2	1-1/2"	56.3	57	38,23
16405A-1-5/8	1-5/8"	60	57	41,77
16405A-1-11/16	1-11/16"	62.5	62	45,79
16405A-1-3/4	1-3/4"	65	62	45,79
16405A-1-7/8	1-7/8"	68.8	62	50,63
16405A-2	2"	72.5	62	66,00



CHIAVI A BUSSOLA A MACCHINA SNODATE BOCCA ESAGONALE

articolo	mm	D mm	L mm	Euro
199-17-G-90	17	29	90	58,33
199-18-G-90	18	32	90	58,75
199-19-G-90	19	32	90	58,75
199-21-G-90	21	35	90	64,26
199-22-G-90	22	38	90	66,76
199-24-G-90	24	40	90	66,76
199-27-G-90	27	41	90	66,76
199-30-G-90	30	44	90	67,20
199-32-G-90	32	49	90	67,20
199-34-G-90	34	52	90	67,20
199-36-G-90	36	52	90	70,12
199-38-G-90	38	54	90	73,08
199-41-G-90	41	57	90	78,15
199-46-G-90	46	67	90	89,16



CHIAVI A BUSSOLA A MACCHINA BOCCA ESAGONALE TIPO EXTRA LUNGO SNODATA

articolo	mm	D mm	L mm	Euro
199-17-G-150	17	29	150	62,75
199-18-G-150	18	32	150	63,00
199-19-G-150	19	32	150	63,00
199-21-G-150	21	35	150	68,67
199-22-G-150	22	38	150	69,72
199-24-G-150	24	40	150	71,19
199-27-G-150	27	41	150	71,19
199-30-G-150	30	44	150	71,61
199-32-G-150	32	49	150	71,61
199-34-G-150	34	52	150	71,61
199-36-G-150	36	52	150	74,11
199-38-G-150	38	54	150	75,60
199-41-G-150	41	57	150	80,59
199-46-G-150	46	67	150	95,55



CHIAVI A BUSSOLA A MACCHINA BOCCA SURFACE DRIVE

articolo	mm	D mm	L mm	Euro
16410M-16	16	28,8	50	25,11
16410M-17	17	30	50	25,11
16410M-18	18	31,3	50	25,11
16410M-19	19	32,5	50	25,11
16410M-21	21	35	50	25,11
16410M-22	22	36,3	50	25,11
16410M-24	24	38,8	50	25,11
16410M-27	27	42,5	50	25,11
16410M-30	30	46,3	53	26,48
16410M-32	32	48,8	53	28,11
16410M-33	33	50	55	30,83
16410M-36	36	53,8	55	32,07



CHIAVI A BUSSOLA A MACCHINA BOCCA TORX®

articolo	D mm	L mm	Euro
16425-E18	E 18	26.3	33,06
16425-E20	E 20	28.8	33,06
16425-E22	E 22	31.3	33,06
16425-E24	E 24	32.5	33,06
16425-E26	E 26	35	42,08
16425-E28	E 28	36.3	42,08
16425-E30	E 30	38.8	48,32
16425-E32	E 32	41.3	48,32

TORX® (E)	S in mm	S in mm	
E 4	3,83	E 16	14,71
E 5	4,72	E 18	16,64
E 6	5,69	E 20	18,41
E 7	6,17	E 22	20,24
E 8	7,47	E 24	22,10
E 10	9,37	E 26	23,85
E 11	10,03	E 28	25,65
E 12	11,12	E 30	27,40
E 14	12,85	E 32	29,20

IMPACT 3/4"



CHIAVI A BUSSOLA
A MACCHINA
BOCCA TORX PLUS

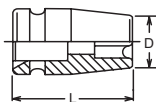

Koken articolo		D mm	L mm		Euro
16425-24EPL	24EPL	32.5	55	1	41,03
16425-32EPL	32EPL	40	62	1	52,03



NEW

QUADRO

CHIAVI A
BUSSOLA CON
BOCCA QUADRO
FEMMINA

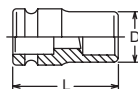

Koken articolo		D mm	L mm		Euro
PS 6-17		17	40	1	33,91
PS 6-19		19	40	1	33,91
PS 6-20		20	44	1	34,43
PS 6-21		21	44	1	34,43

3/4"

ESAGONO

LUNGHE

attacco: 3/4"
impronta: ESAGONO

FERMEC articolo		L mm		Euro
199-16 L	16	95	1	32,00
199-17 L	17	95	1	32,00
199-18 L	18	95	1	32,00
199-19 L	19	95	1	32,00
199-20 L	20	95	1	32,00
199-21 L	21	95	1	32,00
199-22 L	22	95	1	32,00
199-23 L	23	95	1	32,00
199-24 L	24	95	1	32,00
199-25 L	25	95	1	32,00
199-26 L	26	95	1	32,00
199-27 L	27	95	1	32,00
199-28 L	28	95	1	32,00
199-29 L	29	95	1	32,00
199-30 L	30	95	1	32,00
199-32 L	32	95	1	35,67
199-33 L	33	95	1	35,67
199-34 L	34	95	1	35,67
199-35 L	35	95	1	35,67
199-36 L	36	95	1	41,31
199-37 L	37	95	1	41,31
199-38 L	38	95	1	41,31
199-39 L	39	95	1	41,31
199-40 L	40	95	1	41,80
199-41 L	41	95	1	47,44
199-42 L	42	95	1	51,40
199-43 L	43	95	1	54,40
199-44 L	44	95	1	55,20
199-45 L	45	95	1	56,15
199-46 L	46	95	1	60,89
199-47 L	47	95	1	65,29
199-48 L	48	95	1	68,38
199-49 L	49	95	1	69,20
199-50 L	50	95	1	70,98
199-52 L	52	95	1	76,00
199-55 L	55	95	1	78,50
199-60 L	60	100	1	89,00
199-65 L	65	105	1	99,00

TORX PLUS®

S
mm

S
mm

E 4	3.70	E 16	14.60
E 5	4.60	E 18	16.50
E 6	5.60	E 20	18.30
E 7	6.10	E 22	20.10
E 8	7.40	E 24	22.00
E 10	9.30	E 26	23.70
E 11	9.90	E 28	25.50
E 12	11.00	E 30	27.30
E 14	12.80	E 32	29.00



3/4"

RETTANGOLO

RETTANGOLARI

attacco: 3/4"
impronta: RETTANGOLO

FERMEC articolo		L mm		Euro
199-21-28 RVKT	21 x 28	100	1	69,00

3/4"

QUADRO

QUADRO FEMMINA

attacco: 3/4"
impronta: QUADRA

FERMEC articolo		L mm		Euro
199-17 VKT	17	51	1	40,00
199-19 VKT	19	51	1	40,00
199-20 VKT	20	51	1	40,00
199-21 VKT	21	51	1	40,00
199-22 VKT	22	51	1	40,00
199-24 VKT	24	51	1	40,00
199-27 VKT	27	51	1	48,50
199-30 VKT	30	51	1	49,50



3/4"

ESAGONO

LUNGHE ECONOMICHE

attacco: 3/4"
impronta: ESAGONO

BGS articolo	mm	L mm		Euro
BGS 5717	17	95	1	21,04
BGS 5718	18	95	1	21,17
BGS 5719	19	95	1	21,17
BGS 5721	21	95	1	22,44
BGS 5722	22	95	1	22,95
BGS 5724	24	95	1	22,95
BGS 5726	26	95	1	22,95
BGS 5727	27	95	1	23,72
BGS 5730	30	95	1	24,74
BGS 5732	32	95	1	25,25
BGS 5733	33	95	1	27,03
BGS 5734	34	95	1	28,31
BGS 5736	36	95	1	28,56
BGS 5738	38	95	1	29,33
BGS 5741	41	95	1	33,66
BGS 5746	46	95	1	40,80
BGS 5750	50	95	1	47,18
BGS 5755	55	95	1	57,38
BGS 5760	60	100	1	81,60



ESAGONO

CHIAVI A BUSSOLA
A MACCHINA
BOCCA ESAGONALE
TIPO LUNGO

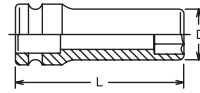

Koken articolo	mm	D mm	L mm		Euro
16300M-14	14	26.3	100	1	39,77
16300M-16	16	28.8	100	1	39,77
16300M-17	17	30	100	1	39,77
16300M-18	18	31.3	100	1	39,77
16300M-19	19	32.5	100	1	39,77
16300M-20	20	33.8	100	1	39,77
16300M-21	21	35	100	1	39,77
16300M-22	22	36.3	100	1	39,77
16300M-23	23	37.5	100	1	39,77
16300M-24	24	38.8	100	1	39,77
16300M-25	25	40	100	1	39,77
16300M-26	26	41.3	100	1	39,77
16300M-27	27	42.5	100	1	39,77
16300M-28	28	43.8	100	1	40,45
16300M-29	29	45	100	1	40,45
16300M-30	30	46.3	100	1	40,45
16300M-31	31	47.5	100	1	40,45
16300M-32	32	48.8	100	1	43,64
16300M-33	33	50	100	1	44,94
16300M-34	34	51.3	100	1	44,94
16300M-35	35	52.5	100	1	44,94
16300M-36	36	53.8	100	1	50,82
16300M-37	37	55	100	1	52,31
16300M-38	38	56.3	100	1	52,31
16300M-40	40	58.8	100	1	52,31
16300M-41	41	60	100	1	57,78
16300M-42	42	61.3	100	1	64,68
16300M-43	43	62.5	100	1	67,35
16300M-44	44		100	1	75,98
16300M-46	46	66.3	100	1	75,98
16300M-48	48	68.8	100	1	83,24
16300M-50	50	71.3	100	1	90,23
16300M-55	55	77.5	100	1	112,45
16300M-60	60	83.8	100	1	126,47

PARETI SOTTILI



ESAGONO

CHIAVI A BUSSOLA
A MACCHINA
BOCCA ESAGONALE
TIPO LUNGO
PARETI SOTTILI

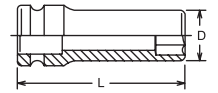

Koken articolo	mm	D mm	L mm		Euro
16301M-16	16	26.8	100	1	39,77
16301M-17	17	28	100	1	39,77
16301M-18	18	29.3	100	1	39,77
16301M-19	19	30.5	100	1	39,77
16301M-20	20	31.8	100	1	39,77
16301M-21	21	33	100	1	39,77
16301M-22	22	34.3	100	1	39,77
16301M-23	23	35.5	100	1	39,77
16301M-24	24	36.8	100	1	39,77
16301M-25	25	38	100	1	39,77
16301M-26	26	39.3	100	1	39,77
16301M-27	27	40.5	100	1	40,45
16301M-28	28	41.8	100	1	40,45
16301M-29	29	43	100	1	40,45
16301M-30	30	44.3	100	1	40,45
16301M-31	31	45.5	100	1	40,73
16301M-32	32	48.8	100	1	44,94
16301M-33	33	48	100	1	44,94
16301M-34	34	49.3	100	1	44,94
16301M-35	35	50.5	100	1	46,59
16301M-36	36	51.8	100	1	52,31
16301M-37	37	53	100	1	52,31
16301M-38	38	54.3	100	1	52,31
16301M-40	40	56.8	100	1	52,31
16301M-41	41	58	100	1	57,78
16301M-42	42	59.3	100	1	64,68
16301M-46	46	64.3	100	1	75,98
16301M-50	50	69.2	100	1	90,23



3/4"

ESAGONO

CV

PRO+

BGS articolo	DESCRIZIONE	Euro
BGS 5241	SET 8 PEZZI BUSSOLE A MACCHINA LUNGHE	161,25

CARATTERISTICHE

- brunite
- con scanalatura e foro per spina
- lunghezza 90 mm
- 22-24-27-28-30-32-36-38 mm



IMPACT 3/4"

PARETI SOTTILI
SEMI-LUNGA



CHIAVI A BUSSOLA
A MACCHINA
BOCCA ESAGONALE
TIPO SEMI LUNGO

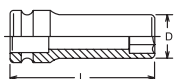

Kokon articolo	mm	D mm	L mm		Euro
16301X-17	17	28	75	1	39,13
16301X-18	18	29.3	75	1	39,13
16301X-19	19	30.5	75	1	39,13
16301X-20	20	31.8	75	1	39,13
16301X-21	21	33	75	1	39,13
16301X-22	22	34.3	75	1	39,13
16301X-23	23	35.5	75	1	39,13
16301X-24	24	36.8	75	1	39,13
16301X-25	25	38	75	1	39,13
16301X-26	26	39.3	75	1	41,53
16301X-27	27	40.5	75	1	41,53
16301X-28	28	41.8	75	1	41,53
16301X-29	29	43	75	1	41,53
16301X-30	30	44.3	75	1	41,53
16301X-31	31	45.5	75	1	43,42
16301X-32	32	46.8	75	1	43,42
16301X-33	33	48	75	1	45,29
16301X-35	35	50.5	75	1	47,58
16301X-36	36	51.8	75	1	49,80
16301X-37	37	53	75	1	53,90
16301X-38	38	54.3	80	1	53,90
16301X-40	40	56.8	80	1	54,89
16301X-41	41	58	80	1	59,21
16301X-46	46	64.3	80	1	74,99



CHIAVI A BUSSOLA
A MACCHINA
BOCCA SURFACE
DRIVE

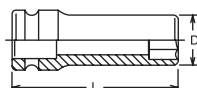

TIPO LUNGO

Kokon articolo	mm	D mm	L mm		Euro
16310M-16	16	28,8	100	1	42,90
16310M-17	17	30	100	1	42,90
16310M-18	18	31,3	100	1	42,90
16310M-19	19	32,5	100	1	42,90
16310M-21	21	35	100	1	42,90
16310M-22	22	36,3	100	1	42,90
16310M-24	24	38,8	100	1	42,90
16310M-27	27	42,5	100	1	42,90
16310M-30	30	46,3	100	1	43,23
16310M-32	32	48,8	100	1	48,32
16310M-33	33	50	100	1	48,32
16310M-36	36	53,8	100	1	56,21

POLLICI



LUNGHE

attacco: 3/4"
impronta: ESAGONO

FERMEC articolo	pollici	L mm		Euro
199-3/4 L	3/4"	90	1	42,39
199-13/16 L	13/16"	90	1	42,39
199-7/8 L	7/8"	90	1	42,39
199-15/16 L	15/16"	90	1	42,39
199-1 L	1"	90	1	42,39
199-1-1/8 L	1-1/8"	90	1	42,68
199-1-1/4 L	1-1/4"	90	1	47,47
199-1-5/16 L	1-5/16"	90	1	53,08
199-1-7/16 L	1-7/16"	90	1	53,08
199-1-9/16 L	1-9/16"	90	1	60,76
199-1-11/16 L	1-11/16"	90	1	63,18
199-1-3/4 L	1-3/4"	90	1	78,60
199-1-7/8 L	1-7/8"	90	1	78,60
199-1-15/16 L	1-15/16"	90	1	89,66
199-2 L	2"	90	1	89,66

POLLICI



CHIAVI A BUSSOLA
A MACCHINA
BOCCA ESAGONALE
TIPO LUNGO

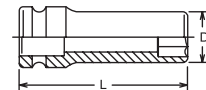

Kokon articolo	pollici	D mm	L mm		Euro
16300A-3/4	3/4"	32.5	100	1	42,85
16300A-13/16	13/16"	35	100	1	42,85
16300A-7/8	7/8"	36.3	100	1	42,85
16300A-15/16	15/16"	38.8	100	1	42,85
16300A-1	1"	40	100	1	42,85
16300A-1-1/16	1-1/16"	42.5	100	1	42,85
16300A-1-1/8	1-1/8"	45	100	1	43,53
16300A-1-3/16	1-3/16"	46.3	100	1	43,53
16300A-1-1/4	1-1/4"	48.8	100	1	47,03
16300A-1-5/16	1-5/16"	51.3	100	1	48,43
16300A-1-3/8	1-3/8"	52.5	100	1	48,43
16300A-1-7/16	1-7/16"	55	100	1	56,35
16300A-1-1/2	1-1/2"	56.3	100	1	56,35
16300A-1-9/16	1-9/16"	58.8	100	1	56,35
16300A-1-5/8	1-5/8"	60	100	1	62,32
16300A-1-11/16	1-11/16"	62.5	100	1	72,55
16300A-1-3/4	1-3/4"	65	100	1	72,55
16300A-1-13/16	1-13/16"	66.3	100	1	81,84
16300A-1-7/8	1-7/8"	68.8	100	1	89,71
16300A-2	2"	72.5	100	1	97,21



BGS articolo	DESCRIZIONE	Euro
BGS 5250	SET 6 PEZZI BUSSOLE A MACCHINA TIPO LUNGO	161,25

CARATTERISTICHE

- per utilizzo a macchina
- lunghezza 110 mm
- comprende:
 - Torx femmina E18-E20-E22-E24
 - poligonale 17 e 19 mm
- per viti testata cilindri di autocarri, ad es.:
 - MB 300-400-420-500-900;
 - MAN M 2000, F90, F8, D20, D25, D28

RICAMBI

BGS articolo	DESCRIZIONE	Euro
BGS 5345	BUSSOLA POLIGONALE, ATT. 3/4", 17 MM	26,78
BGS 5346	BUSSOLA POLIGONALE, ATT. 3/4", 19 MM	28,05
BGS 5347	BUSSOLA TORX, ATT. 3/4", E18	27,41
BGS 5348	BUSSOLA TORX, ATT. 3/4", E20	28,56
BGS 5349	BUSSOLA TORX, ATT. 3/4", TORX E24	29,07



CHIAVI A BUSSOLA A MACCHINA BOCCA POLIGONALE TIPO LUNGO

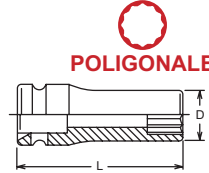

Koken articolo	mm	D mm	L mm	Euro
16305M-14	14	26.3	100	41,75
NEW 16305M-16	16	28.8	100	41,75
16305M-17	17	30	100	41,75
16305M-18	18	31.3	100	41,75
16305M-19	19	32.5	100	41,75
16305M-21	21	35	100	41,75
16305M-22	22	36.3	100	41,75
16305M-23	23	37.5	100	41,75
16305M-24	24	38.8	100	41,75
16305M-26	26	41.3	100	41,75
16305M-27	27	42.5	100	41,75
16305M-28	28	43.8	100	42,43
16305M-29	29	45	100	42,43
16305M-30	30	46.3	100	42,43
16305M-32	32	48.8	100	45,82
NEW 16305M-33	33	50	100	47,19
NEW 16305M-34	34	51.3	100	47,19
16305M-35	35	52.5	100	47,19
16305M-36	36	53.8	100	53,38
16305M-38	38	56.3	100	54,92
16305M-41	41	60	100	60,72
16305M-46	46	66.3	100	79,72
NEW 16305M-50	50	71.3	100	94,74

TORX®	S mm	S mm	
E 4	3.70	E 16	14.60
E 5	4.60	E 18	16.50
E 6	5.60	E 20	18.30
E 7	6.10	E 22	20.10
E 8	7.40	E 24	22.00
E 10	9.30	E 26	23.70
E 11	9.90	E 28	25.50
E 12	11.00	E 30	27.30
E 14	12.80	E 32	29.00



CHIAVI A BUSSOLA A MACCHINA BOCCA TORX® TIPO LUNGO

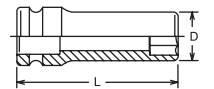

Koken articolo	TORX	D mm	L mm	Euro
16325-E18	E 18	26.3	100	41,80
16325-E20	E 20	28.8	100	41,80
16325-E22	E 22	31.3	100	41,80
16325-E24	E 24	32.5	100	41,80
NEW 16325-E26	E 26	35	100	53,87
NEW 16325-E28	E 28	36.3	100	53,87
NEW 16325-E30	E 30	38.8	100	58,55
NEW 16325-E32	E 32	41.3	100	58,55
199-26 GTXL	E 26		110	40,97
199-28 GTXL	E 28		110	40,97
199-30 GTXL	E 30		110	40,97
199-32 GTXL	E 32		110	40,97



CHIAVI A BUSSOLA A MACCHINA ECONOMICHE BOCCA TORX® TIPO LUNGO



BGS articolo	TORX	L mm	Euro
BGS 5347	E 18	110	27,41
BGS 5348	E 20	110	28,56
BGS 5349	E 24	110	29,07
BGS 5250-E26	E 26	110	33,15
BGS 5250-E28	E 28	110	34,43
BGS 5250-E30	E 30	110	35,70
BGS 5250-E32	E 32	110	38,25



IMPACT 3/4"



ISUZU

ESAGONO QUADRO

CHIAVI A BUSSOLA
A MACCHINA PER
AUTOTRENO

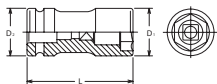

Koken articolo	mm	mm	L mm	€uro
16316M-35x17	35	17	90	54,56
16316M-38x20	38	20	100	62,23
16316M-41x19	41	19	100	70,81
16316M-41x21	41	21	100	70,81

POLLICI

16316A-1-1/2x13/16	1-1/2"	13/16	100	70,26
--------------------	--------	-------	-----	-------



CHIAVI A BUSSOLA EXTRA LUNGHE VUOTE

Koken articolo	mm	D mm	L mm	€uro
16102M-270-24	24	38.8	270	109,26
16102M-270-27	27	42.5	270	109,26
16102M-270-30	30	46.3	270	109,26
16102M-270-32	32	48.8	270	116,05
16102M-270-33	33	50	270	116,05
16102M-270-36	36	53.8	270	117,51
16102M-270-38	38	56.3	270	239,77
16102M-270-41	41	60	270	239,77
16102M-270-46	46		270	378,00
16102M-270-50	50		270	456,75
16102M-400-24	24	38.8	400	131,20
16102M-400-27	27	42.5	400	131,20
16102M-400-30	30	46.3	400	131,20
16102M-400-32	32	48.8	400	135,27
16102M-400-33	33	50	400	135,27
16102M-400-36	36	53.8	400	135,74

BARRE DI
TORSIONE



BARRE DI TORSIONE BOCCA ESAGONALE

Koken articolo	Nm	D mm	L mm	€uro	
16101M-24 X 180 NM	24	180	38.8	235	106,81
16101M-27 X 450 NM	27	450	42.5	280	110,41
16101M-32 X 600 NM	32	600	48.8	280	115,47
16101M-33 X 600 NM	33	600	50	280	114,70

Non utilizzare la barra di torsione per
svitare i dadi, ma solo per avvitare.

Per sicurezza, controllare sempre il
serraggio con chiave dinamometrica.



41 mm

SCANIA
PRO+

BGS articolo	DESCRIZIONE	€uro
BGS 5410	BUSSOLA PER AUTOCARRI, RUOTA POSTERIORE, 111 MM, PER BPW 12T	246,25

CARATTERISTICHE

- per dadi assi BPW 12T
- attacco esagonale 41 mm



41 mm

SCANIA PRO+ OTTAGONALE

BGS articolo	DESCRIZIONE	€uro
BGS 5413	BUSSOLA PER AUTOCARRI, RUOTA POSTERIORE, 80 MM, ASSE ANTERIORE SCANIA	181,25

CARATTERISTICHE

- 8 lati
- attacco esagonale 41 mm



3/4"

SCANIA VOLVO OTTAGONALE
PRO+

BGS articolo	DESCRIZIONE	€uro
BGS 5416	8 LATI, 115 MM, VOLVO	228,75
BGS 5417	8 LATI, 100 MM, SCANIA	228,75

CARATTERISTICHE

- art. BGS 5416 per dadi asse per Volvo
- art. BGS 5417 per dadi asse per Scania





BUSSOLE ESAGONALI MASCHIO BRUNITE CON FORO NEL QUADRO PER SPINA E ANELLO

attacco: 3/4"

impronta: ESAGONO BRUGOLA

FEIMEC articolo	mm	L mm		Euro
BGS 5054-12	12	55	1	28,55
BGS 5054-14	14	55	1	28,55
BGS 5054-17	17	55	1	28,55
BGS 5054-19	19	55	1	28,55
BGS 5054-21	21	55	1	28,55
BGS 5054-22	22	55	1	28,55
BGS 5054-23	23	55	1	28,55
BGS 5054-24	24	55	1	28,55

182 - 3/4" - 10	10	60	1	32,55
182 - 3/4" - 12	12	60	1	32,55
182 - 3/4" - 13	13	60	1	32,55
182 - 3/4" - 14	14	60	1	32,55
182 - 3/4" - 15	15	60	1	32,55
182 - 3/4" - 17	17	60	1	32,55
182 - 3/4" - 19	19	65	1	32,55
182 - 3/4" - 21	21	70	1	32,55
182 - 3/4" - 22	22	70	1	32,55
182 - 3/4" - 23	23	70	1	32,55
182 - 3/4" - 24	24	70	1	32,55

1182 - 3/4" - 10	10	100	1	58,01
1182 - 3/4" - 12	12	100	1	58,01
1182 - 3/4" - 14	14	100	1	58,01
1182 - 3/4" - 17	17	100	1	58,01
1182 - 3/4" - 19	19	100	1	58,01
1182 - 3/4" - 22	22	100	1	58,01
1182 - 3/4" - 24	24	100	1	58,01
1182 - 3/4" - 27	27	100	1	58,01
1182 - 3/4" - 30	30	100	1	62,56
1182 - 3/4" - 32	32	100	1	62,56

3182 - 3/4" - 10	10	150	1	60,90
3182 - 3/4" - 12	12	150	1	60,90
3182 - 3/4" - 14	14	150	1	60,90
3182 - 3/4" - 17	17	150	1	60,90
3182 - 3/4" - 19	19	150	1	60,90
3182 - 3/4" - 22	22	150	1	60,90
3182 - 3/4" - 24	24	150	1	60,90



FEIMEC articolo	DESCRIZIONE	Euro
541061	SET 6 PEZZI, BUSSOLE IMPACT ATT. 3/4", ESAGONALE MASCHIO	297,90

CARATTERISTICHE

- lunghezza 100 mm
- atta quadro femmina 3/4"
- misure: 12-14-17-19-22-24 mm
- in cassetta metallica



PER USO A MANO

CHIAVI A BUSCOLA MASCHIO ESAGONALE INTEGRALE

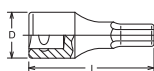

Koken articolo	mm	D mm	L mm		Euro
6012M-12	12	35	75	1	22,88
6012M-14	14	35	75	1	22,88
6012M-15	15	35	75	1	22,88
6012M-16	16	35	75	1	22,88
6012M-17	17	35	75	1	22,88
6012M-18	18	35	75	1	22,88
6012M-19	19	35	75	1	22,88
6012M-20	20	37.9	75	1	25,49
6012M-22	22	37.9	75	1	26,02
6012M-24	24	37.9	75	1	26,02
6012M-27	27	37.9	75	1	26,02
6012M-30	30	38	75	1	48,70
6012M-32	32	38	75	1	49,20
6012M-36	36	42	75	1	49,20

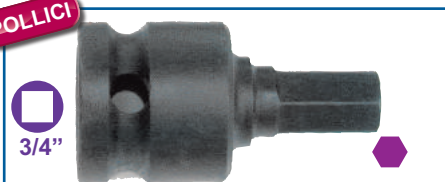

BUSSOLE ESAGONALI MASCHIO BRUNITE CON FORO NEL QUADRO PER SPINA E ANELLO - MISURE IN POLLICI

attacco: 3/4"

impronta: ESAGONO BRUGOLA

FEIMEC articolo	pollici	L mm		Euro
182 W-3/4"-3/8"	3/8"	67	1	37,01
182 W-3/4"-7/16"	7/16"	67	1	37,01
182 W-3/4"-1/2"	1/2"	67	1	37,01
182 W-3/4"-9/16"	9/16"	67	1	37,01
182 W-3/4"-5/8"	5/8"	67	1	37,01
182 W-3/4"-3/4"	3/4"	67	1	37,01
182 W-3/4"-7/8"	7/8"	71	1	37,01
182 W-3/4"-1"	1"	71	1	37,01

841012	3/8"	100	1	58,28
841014	7/16"	100	1	58,28
841016	1/2"	100	1	58,28
841018	9/16"	100	1	58,28
841020	5/8"	100	1	58,28
841024	3/4"	100	1	58,28
841026	13/16"	100	1	58,28
841028	7/8"	100	1	58,28
841100	1"	100	1	58,28

IMPACT 3/4"

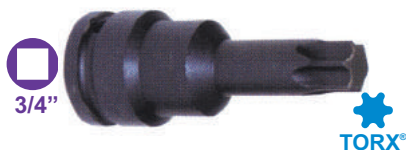

BUSSOLE TORX® MASCHIO BRUNITE CON FORO NEL QUADRO PER SPINA E ANELLO

attacco: 3/4"
impronta: TX

articolo	Impronta	L mm	Quantità	Euro
716080	TX 80	60	1	31,50
716090	TX 90	60	1	31,50
716100	TX 100	60	1	31,50
742050	TX 50	100	1	68,25
742055	TX 55	100	1	68,25
742060	TX 60	100	1	68,25
742070	TX 70	100	1	68,25
742080	TX 80	100	1	68,25
742090	TX 90	100	1	68,25
742100	TX 100	100	1	68,25



CHIAVI A BUSSOLA MASCHIO TORX ATTACCO 3/4", LUNGHEZZA 60 MM

articolo	Impronta	L mm	Quantità	Euro
BGS 5545	TX 45	60	1	25,40
BGS 5550	TX 50	60	1	25,40
BGS 5555	TX 55	60	1	25,40
BGS 5560	TX 60	60	1	25,40
BGS 5565	TX 65	60	1	25,40
BGS 5570	TX 70	60	1	25,40
BGS 5580	TX 80	60	1	28,50
BGS 5590	TX 90	60	1	28,50
BGS 5600	TX 100	60	1	28,50

CARATTERISTICHE

- idonee per utilizzo a mano e a macchina
- con scanalatura e foro per spina



articolo	Impronta	L mm	Euro
BGS 5054-M16	M 16	55	25,00
BGS 5054-M18	M 18	55	25,00
BGS 5054-M24	M 24	60	27,00

CARATTERISTICHE

- per utilizzo a macchina
- lunghezza 55 mm
- con scanalatura e foro per spina



articolo	DESCRIZIONE	Euro
BGS 5054	SET 9 PEZZI, CHIAVI A BUSSOLA A MACCHINA ESAGONALI	161,25

CARATTERISTICHE

- per utilizzo a macchina
- lunghezza 55 mm
- bussole esagonali: 14 - 17 - 19 - 21 - 22 - 23 - 24 mm
- bussole XZN: M16 - M18

TORX®	S mm	S mm	
T 6	1.70	T 40	6.70
T 7	2.00	T 45	7.90
T 8	2.30	T 50	8.90
T 9	2.50	T 55	11.30
T 10	2.70	T 60	13.30
T 15	3.30	T 70	15.60
T 20	3.90	T 80	17.60
T 25	4.50	T 90	20.00
T 27	5.00	T 100	22.20
T 30	5.60		



articolo	DESCRIZIONE	Euro
BGS 5055	SET 6 PEZZI, BUSSOLE IMPACT TORX, ATT. 3/4"	114,50

CARATTERISTICHE

- comprende le seguenti chiavi a bussola: TX55 - TX60 - TX70 - TX80 - TX90 - TX100
- lunghezza: 60 mm
- materiale: cromo molibdeno, forgiato



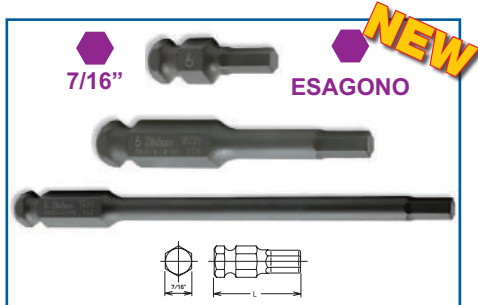

INSERTO CON MASCHIO ESAGONALE

Koken articolo	mm	L mm		Euro
183H-35-3	3	35	1	6,90
183H-35-4	4	35	1	6,90
183H-35-5	5	35	1	6,90
183H-35-6	6	35	1	6,90
183H-35-7	7	35	1	7,12
183H-35-8	8	35	1	7,12
183H-35-10	10	35	1	7,12
183H-35-11	11	35	1	11,52
183H-35-12	12	35	1	11,52
183H-35-14	14	35	1	11,96
183H-35-16	16	35	1	11,96
183H-35-17	17	35	1	11,96
183H-35-18	18	35	1	17,77
183H-35-19	19	35	1	17,77
183H-75-3	3	75	1	9,02
183H-75-4	4	75	1	9,02
183H-75-5	5	75	1	9,02
183H-75-6	6	75	1	9,02
183H-75-7	7	75	1	9,02
183H-75-8	8	75	1	9,02
183H-75-10	10	75	1	9,02
183H-75-11	11	75	1	13,09
183H-75-12	12	75	1	13,48
183H-75-14	14	75	1	14,47
183H-150-4	4	150	1	13,75
183H-150-5	5	150	1	13,75
183H-150-6	6	150	1	13,75
183H-150-8	8	150	1	13,75
183H-150-10	10	150	1	13,75
183H-150-12	12	150	1	19,88

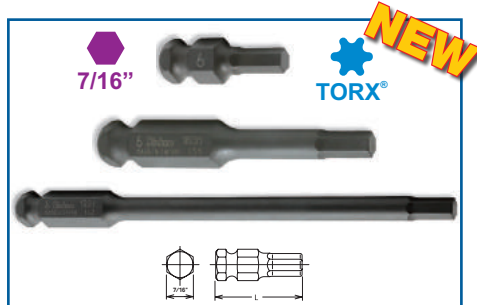

INSERTO CON MASCHIO TORX®

Koken articolo		L mm		Euro
183T-35-T25	TX 25	35	1	8,58
183T-35-T30	TX 30	35	1	8,58
183T-35-T40	TX 40	35	1	8,58
183T-35-T45	TX 45	35	1	8,58
183T-35-T50	TX 50	35	1	8,80
183T-35-T55	TX 55	35	1	8,80
183T-35-T60	TX 60	35	1	14,27
183T-75-T30	TX 30	75	1	9,52
183T-75-T40	TX 40	75	1	9,52
183T-75-T45	TX 45	75	1	9,52
183T-75-T50	TX 50	75	1	9,52
183T-75-T55	TX 55	75	1	9,52
183T-75-T60	TX 60	75	1	16,36
183T-150-T30	TX 30	150	1	14,80
183T-150-T40	TX 40	150	1	14,80
183T-150-T45	TX 45	150	1	14,80
183T-150-T50	TX 50	150	1	14,80
183T-150-T55	TX 55	150	1	14,80

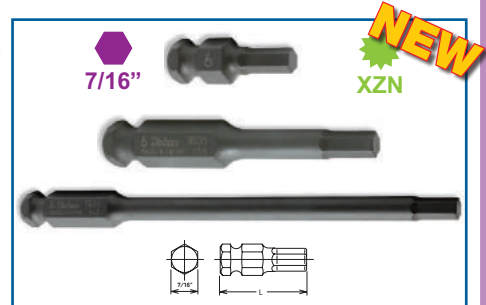

INSERTO CON MASCHIO XZN

Koken articolo		L mm		Euro
183X-35-M 4	M 4	35	1	8,83
183X-35-M 5	M 5	35	1	8,83
183X-35-M 6	M 6	35	1	8,83
183X-35-M 8	M 8	35	1	8,83
183X-35-M10	M10	35	1	9,35
183X-35-M12	M12	35	1	13,34
183X-35-M14	M14	35	1	14,27
183X-75-M 4	M 4	75	1	10,45
183X-75-M 5	M 5	75	1	10,45
183X-75-M 6	M 6	75	1	10,45
183X-75-M 8	M 8	75	1	10,45
183X-75-M10	M10	75	1	10,62
183X-75-M12	M12	75	1	15,79
183X-75-M14	M14	75	1	16,89
183X-150-M 5	M 5	150	1	17,19
183X-150-M 6	M 6	150	1	17,19
183X-150-M 8	M 8	150	1	21,42
183X-150-M10	M10	150	1	21,42
183X-150-M12	M12	150	1	26,07

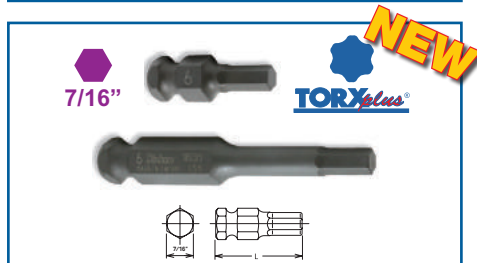

INSERTO CON MASCHIO TORX PLUS®

Koken articolo		L mm		Euro
183T-35-30IP	30IP	35	1	10,04
183T-35-40IP	40IP	35	1	10,04
183T-35-45IP	45IP	35	1	10,04
183T-35-50IP	50IP	35	1	10,45
183T-35-55IP	55IP	35	1	10,45
183T-35-60IP	60IP	35	1	17,60
183T-75-30IP	30IP	75	1	11,85
183T-75-40IP	40IP	75	1	11,85
183T-75-45IP	45IP	75	1	11,85
183T-75-50IP	50IP	75	1	11,85
183T-75-55IP	55IP	75	1	11,85
183T-75-60IP	60IP	75	1	20,10



13134-SC

BUSSOLA PORTA INSERTI DA 7/16"

Koken articolo	D mm	L mm		Euro
16134	44	52	1	37,04

RICAMBI

Koken articolo	DESCRIZIONE	Euro
13134-SC	GRANO DI RICAMBIO M8X5, ESAGONO 4 MM	1,10

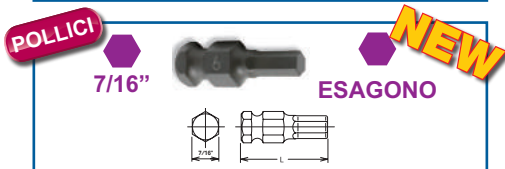

INSERTO CON MASCHIO ESAGONALE

Koken articolo	POLLICI	L mm		Euro
183H-35-3/16	3/16"	35	1	7,34
183H-35-7/32	7/32"	35	1	7,34
183H-35-1/4	1/4"	35	1	7,34
183H-35-5/16	5/16"	35	1	7,84
183H-35-3/8	3/8"	35	1	7,84
183H-35-7/16	7/16"	35	1	7,84
183H-35-1/2	1/2"	35	1	13,15

IMPACT 3/4"

1/2"



16 mm

**BUSSOLA
PORTAINSERI
16 mm**

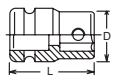

Koken articolo	D mm	L mm		Euro
14106	30	43	1	20,38

3/4"



16 mm

**BUSSOLA
PORTAINSERI
16 mm**

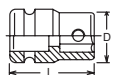

Koken articolo	D mm	L mm		Euro
16106	32	52	1	30,00

1"



16 mm

**BUSSOLA
PORTAINSERI
16 mm**

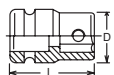

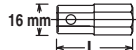

Koken articolo	D mm	L mm		Euro
18106	54	68	1	47,63

16 mm ESAGONO



INSERTO CON MASCHIO ESAGONALE



Koken articolo		L mm		Euro
107-16-10	10	40	1	8,31
107-16-12	12	40	1	8,31
107-16-13	13	40	1	8,31
107-16-14	14	40	1	8,31
107-16-16	16	40	1	9,13
107-16-17	17	40	1	9,13
107-16-18	18	40	1	9,68
107-16-19	19	40	1	9,68
107-16-22	22	40	1	11,03
NEW 107-16-100-10	10	100	1	19,69
NEW 107-16-100-12	12	100	1	19,69
NEW 107-16-100-14	14	100	1	19,69
NEW 107-16-100-17	17	100	1	20,21
NEW 107-16-100-19	19	100	1	32,62
NEW 107-16-100-22	22	100	1	34,46
POLLICI				
NEW 107-16-3/8	3/8"	40	1	8,97
107-16-1/2	1/2"	40	1	8,97
107-16-9/16	9/16"	40	1	8,97
107-16-5/8	5/8"	40	1	9,82
107-16-3/4	3/4"	40	1	10,45

16 mm TORX®



INSERTO CON MASCHIO TORX®





Koken articolo		L mm		Euro
107-16-T55	TX 55	50	1	13,86
107-16-T60	TX 60	50	1	13,86
107-16-T70	TX 70	50	1	13,86
NEW 107-16-100-T55	TX 55	100	1	21,48
NEW 107-16-100-T60	TX 60	100	1	21,97
NEW 107-16-100-T70	TX 70	100	1	22,61

16 mm TORX PLUS®



INSERTO CON MASCHIO TORX PLUS®





Koken articolo		L mm		Euro
NEW 107-16-55IP	55IP	50	1	16,36
NEW 107-16-60IP	60IP	50	1	16,47
NEW 107-16-70IP	70IP	50	1	16,47

16 mm XZN



INSERTO CON MASCHIO XZN



Koken articolo		L mm		Euro
107-16-M14	M 14	60	1	10,29
107-16-M16	M 16	60	1	10,29
107-16-M18	M 18	60	1	12,10
NEW 107-16-100-M14	M 14	100	1	22,03
NEW 107-16-100-M16	M 16	100	1	22,61
NEW 107-16-100-M18	M 18	100	1	34,35



ESAGONO TORX®

FEEMEC articolo	DESCRIZIONE	Euro
TS 110	TRUCKS SOCKETS SET IN CASSETTA METALLICA	236,19

CARATTERISTICHE

- specifico per veicoli industriali e movimento terra
- set 11 pezzi
- chiavi esagonali a L per fissaggio inserti sulle bussole
- inserti attacco esagonale 16 e 22 mm

RICAMBI

FEEMEC	DESCRIZIONE	Euro
107-16-12	INS. ESAG. 12 MM, ATT. 16 MM	8,31
107-16-14	INS. ESAG. 14 MM, ATT. 16 MM	8,31
107-16-17	INS. ESAG. 17 MM, ATT. 16 MM	9,13
107-16-19	INS. ESAG. 19 MM, ATT. 16 MM	9,68
107-16-22	INS. ESAG. 22 MM, ATT. 16 MM	11,03
107-16-T55	INS. TORX TX55, ATT. 16 MM	13,86
107-16-T60	INS. TORX TX60, ATT. 16 MM	13,86
107-16-T70	INS. TORX TX70, ATT. 16 MM	13,86
107-22-T80	INS. TORX TX80, ATT. 22 MM	27,56
107-22-T90	INS. TORX TX90, ATT. 22 MM	27,75
107-22-T100	INS. TORX TX100, ATT. 22 MM	27,94
16106	BUSSOLA PORTA PUNTE QUADRO 3/4", ESAG. 16 MM	30,00
18107	BUSSOLA PORTA PUNTE QUADRO 1", ESAG. 22 MM	47,63





16107-SC

BUSSOLA PORTAINSERTI 22 mm

Koken articolo	D mm	L mm	Box	Euro
16107	44	60	1	32,69

RICAMBI

Koken articolo	DESCRIZIONE	Euro
16107-SC	GRANO DI RICAMBIO M8X14, ESAGONO 4 MM	0,74



22 mm **ESAGONO**

INSERTO CON MASCHIO ESAGONALE PER USO CON BUSSOLA 16107

FEEMEC articolo	mm	L mm	Box	Euro
7 RB 014	14	107/140	1	20,48
7 RB 017	17	107/140	1	20,48
7 RB 019	19	107/140	1	20,48
7 RB 022	22	107/140	1	20,48
7 RB 024	24	107/140	1	20,48



22 mm **TORX®**

INSERTO CON MASCHIO TORX® PER USO CON BUSSOLA 18107

FEEMEC articolo	mm	L mm	Box	Euro
7 LB 060	TX 60	107/140	1	26,25
7 LB 070	TX 70	107/140	1	26,25
7 LB 080	TX 80	107/140	1	26,25
7 LB 090	TX 90	107/140	1	26,25
7 LB 100	TX 100	107/140	1	26,25



BG articolo	DESCRIZIONE	Euro
BGS 5246	SET 16 PEZZI INSERTI XXL	224,88

CARATTERISTICHE

- 13 inserti, attacco esagonale 22 mm:
 - Torx: Tx60, Tx70, Tx 80, Tx 90, Tx 100
 - Esagono: 17, 19, 22, 24 mm
 - Torx femmina: E18, E20, E22, E24
- 2 bussole porta inserti da 22 mm, attacco quadro femmina da 3/4" e 1"
- chiavi esagonali a L per fissaggio inserti sulle bussole
- per uso con avvitatori pneumatici
- inserti attacco esagonale 22 mm
- lunghezza inserti 100 mm

RICAMBI

BG articolo	DESCRIZIONE	Euro
BGS 5246-T60	INSERTO TX 60	17,34
BGS 5246-T70	INSERTO TX 70	17,85
BGS 5246-T80	INSERTO TX 80	19,13
BGS 5246-T90	INSERTO TX 90	20,40
BGS 5246-T100	INSERTO TX 100	21,68
BGS 5246-E18	INSERTO E-18	17,34
BGS 5246-E20	INSERTO E-20	17,34
BGS 5246-E22	INSERTO E-22	18,36
BGS 5246-E24	INSERTO E-24	18,36
BGS 5246-H17	INSERTO ESAC. 17 MM	17,34
BGS 5246-H19	INSERTO ESAC. 19 MM	17,60
BGS 5246-H22	INSERTO ESAC. 22 MM	18,36
BGS 5246-H24	INSERTO ESAC. 24 MM	19,13
BGS 5246-2	BUSSOLA ATT. 3/4", PORTAINSERTI 22 MM	15,81
BGS 5246-1	BUSSOLA ATT. 1", PORTAINSERTI 22 MM	24,23

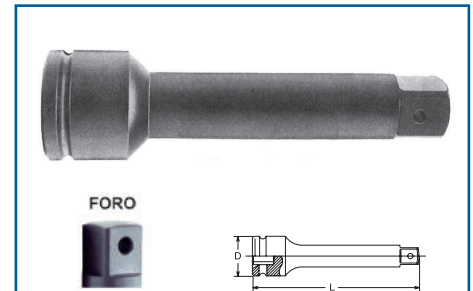

PROLUNGHE PER BUSSOLE "POWER IMPACT" MASCHIO/FEMMINA

FEEMEC articolo	FORO	L mm	Box	Euro
97-13-75	FORO	75	1	34,65
97-13-125	FORO	125	1	34,65
97-13-175	FORO	175	1	34,65
97-14	FORO	250	1	40,67
97-15	FORO	330	1	51,51
97-15-400	FORO	400	1	68,25



Koken articolo	D mm	FORO	L mm	Box	Euro
16760-150	44	FORO	50	1	42,21
16760-175	44	FORO	75	1	42,21
16760-200	44	FORO	100	1	48,37
16760-250	44	FORO	125	1	49,34
16760-330	44	FORO	150	1	60,14

NEW

3/4" **PRO+** **CRO MO** **SFERA**

BG articolo	DESCRIZIONE	Euro
BGS 8840	SET 3 PROLUNGHE IMPACT, ATT. 3/4"	63,75

CARATTERISTICHE

- per uso con avvitatori pneumatici
- lunghezze: 100 - 150 - 250 mm
- con scanalatura e foro per spina
- con sfera di tenuta nel quadro maschio



IMPACT 3/4"



**PROLUNGHE PER BUSSOLE
"POWER IMPACT" MASCHIO/MASCHIO**

FEARMEC articolo	L mm		Euro
Z1203	78	1	21,00
Z1204	101	1	29,40
Z1205	127	1	30,45
Z1207	177	1	70,35

**PAG 657
CON SFERA**



BGS articolo	DESCRIZIONE	Euro
BGS 197	SNODO A MACCHINA	55,00

CARATTERISTICHE

- finitura nera
- con sfera di tenuta nel quadro maschio

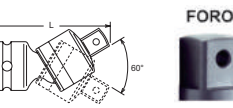

SNODO UNIVERSALE

Koken articolo	L mm		Euro
16770	106	1	84,37

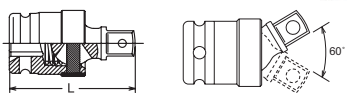

SNODO UNIVERSALE

Koken articolo	L mm		Euro
16771	95	1	83,19



**RACCORDO DI RIDUZIONE
QUADRO MASCHIO 1/2" E FEMMINA 3/4"**

Koken articolo		L mm		Euro
16644A-P	PERNO	54	1	33,50
16644A	FORO	54	1	33,50

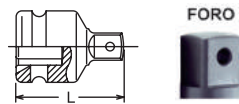

**RACCORDO DI RIDUZIONE
QUADRO MASCHIO 5/8" E FEMMINA 3/4"**

Koken articolo	L mm		Euro
16655A	53	1	36,74

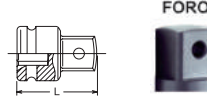

**RACCORDO DI RIDUZIONE
QUADRO MASCHIO 1" E FEMMINA 3/4"**

Koken articolo	L mm		Euro
16688A	62	1	38,23
16688A-250	250	1	91,08
16688A-330	330	1	102,71

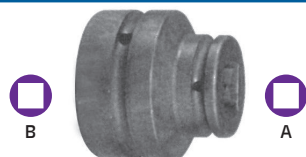

**RIDUZIONI PER BUSSOLE
"POWER IMPACT" FEMMINA/FEMMINA**

FEARMEC articolo	B	A	L mm		Euro
AN 1208	3/4"	1/2"	49	1	39,90
AN 1212	3/4"	3/4"	49	1	42,00
AN 1612	1"	3/4"	63	1	103,95

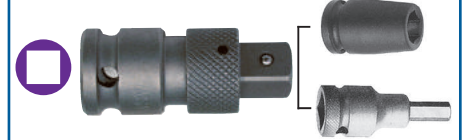

**MANDRINO CON SGANCIO RAPIDO PER
BUSSOLE "POWER IMPACT"**

attacco: Quadro femmina
impronta: DIN 3126, E 11,2 - E 6,35

FEARMEC articolo	F	M	L mm		Euro
195-SWF	1/4"	1/4"	41	1	42,00
196-SWF	3/8"	3/8"	46	1	42,00
197-SWF	1/2"	1/2"	60	1	46,20
199-SWF	3/4"	3/4"	78	1	114,35
1991-SWF	1"	1"	100	1	131,25

Koken	F	M	L mm		Euro
12222 AL	1/4"	1/4"	35	1	50,44
13333 AL	3/8"	3/8"	45	1	53,05
14444 AL	1/2"	1/2"	55	1	58,27
16666 AL	3/4"	3/4"	75	1	121,94
18888 AL	1"	1"	95	1	178,01

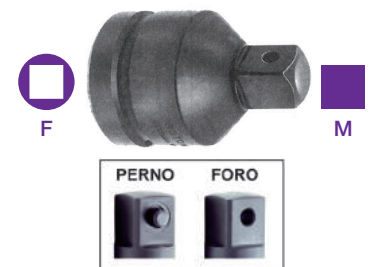

**RACCORDI DI RIDUZIONE "POWER
IMPACT" MASCHIO/FEMMINA**

FEARMEC articolo		F	M	L mm		Euro
96-00	PERNO	1/4"	3/8"	32	1	12,47
⚠ 96-0	PERNO	3/8"	1/4"	35	1	12,47
96-1	PERNO	3/8"	1/2"	45	1	12,47
⚠ 96-01	PERNO	1/2"	1/4"	38	1	13,00
⚠ 96-2	PERNO	1/2"	3/8"	45	1	13,56
96-3	FORO	5/8"	1/2"	50	1	20,07
⚠ 96-4	PERNO	3/4"	1/2"	70	1	23,32
96-5	FORO	3/4"	5/8"	70	1	26,58
96-6	FORO	5/8"	3/4"	70	1	20,61
96-7	FORO	1/2"	5/8"	50	1	16,26
96-8	FORO	3/4"	1"	70	1	28,74
⚠ 96-9	FORO	1"	3/4"	70	1	35,79
⚠ 96-10	PERNO	1"	1/2"	70	1	65,00
96-11	FORO	1/2"	3/4"	50	1	17,89
⚠ 96-12	FORO	1 1/2"	1"	115	1	121,80
96-13	FORO	1"	1 1/2"	115	1	51,51
96-14	FORO	2 1/2"	1 1/2"	115	1	379,60
⚠ 96-15	FORO	1 1/2"	2 1/2"	120	1	260,30
⚠ 96-16	FORO	1 1/4"	1"	140	1	126,00
96-17	FORO	1 3/4"	1 1/2"	150	1	294,00

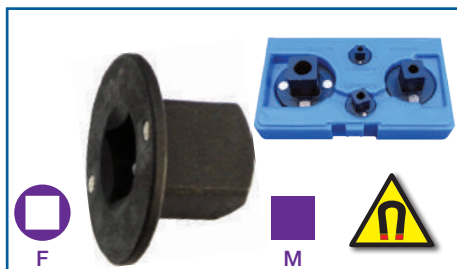

RACCORDI DI RIDUZIONE MAGNETICI "POWER IMPACT" A SCOMPARSA - SPAZI RIDOTTI

articolo	F	M	L mm		Euro
698-00	1/4"	3/8"	17	1	10,00
698-0	1/4"	1/2"	22	1	10,00
698-1	3/8"	1/2"	22	1	10,50
698-11	1/2"	3/4"	30	1	14,70
698-8	3/4"	1"	35	1	21,00
698-13	1"	1 1/2"	50	1	31,50
698-15	1 1/2"	2 1/2"	60	1	210,00

698	CASSETTA 4 PZ. CONTENUTO: 1 PZ. 698-00 1 PZ 698-1 1 PZ. 698-11 1 PZ 698-8			1	63,00
-----	--	--	--	---	-------

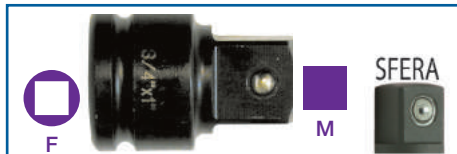

RACCORDI DI RIDUZIONE "POWER IMPACT" MASCHIO/FEMMINA CON SFERA DI TENUTA NEL QUADRO MASCHIO

articolo	F	M	L mm		Euro
696-00 S	1/4"	3/8"	26	1	10,00
⚠ 696-0 S	3/8"	1/4"	32	1	10,00
⚠ 696-01 S	1/2"	1/4"	36	1	10,00
696-1 S	3/8"	1/2"	36	1	10,00
⚠ 696-2 S	1/2"	3/8"	38	1	10,50
696-11 S	1/2"	3/4"	48	1	12,60
⚠ 696-4 S	3/4"	1/2"	56	1	16,80
696-8 S	3/4"	1"	63	1	22,05
⚠ 696-9 S	1"	3/4"	75	1	28,35

 **ARTICOLO NON SOGGETTO A GARANZIA**



BGS articolo	DESCRIZIONE	Euro
BGS 200	SET 6 PEZZI RIDUZIONI A MACCHINA	46,92

CARATTERISTICHE	
• rivestimento specifico nero opaco	
CONTENUTO	
• 1/4" F X 3/8" M, coppia massima 60 Nm	
• 3/8" F X 1/4" M, coppia massima 60 Nm	
• 3/8" F X 1/2" M, coppia massima 200 Nm	
• 1/2" F X 3/8" M, coppia massima 200 Nm	
• 1/2" F X 3/4" M, coppia massima 500 Nm	
• 3/4" F X 1/2" M, coppia massima 500 Nm	

RICAMBI		
BGS articolo	DESCRIZIONE	Euro
NEW BGS 200-LEER	CASSETTA VUOTA	5,46



BGS articolo	DESCRIZIONE	Euro
BGS 25140	SET 11 PEZZI RIDUZIONI E SNODI A MACCHINA	113,48

CARATTERISTICHE	
• rivestimento specifico nero opaco	
CONTENUTO	
• 1/4" F x 3/8" M	
• 3/8" F x 1/4" M	
• 3/8" F x 1/2" M	
• 1/2" F x 3/8" M	
• 1/2" F x 3/4" M	
• 3/4" F x 1/2" M	
• 3/4" F x 1" M	
• 1" F x 3/4" M	
• snodi da 1/4", 3/8", 1/2"	

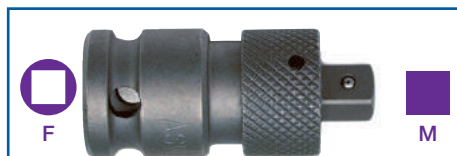

RACCORDI DI RIDUZIONE A MANDRINO CON SGANCIO RAPIDO "POWER IMPACT"

articolo	F	M	L mm		Euro
691-0 SWF	3/8"	1/4"	55	1	31,50
691-1 SWF	3/8"	1/2"	60	1	31,50
691-2 SWF	1/2"	3/8"	55	1	36,75
691-11 SWF	1/2"	3/4"	75	1	42,00
691-4 SWF	3/4"	1/2"	70	1	42,00
691-9 SWF	1"	3/4"	90	1	73,50

BGS articolo	DESCRIZIONE	Euro
BGS 200	SET 6 PEZZI RIDUZIONI A MACCHINA	46,92

CARATTERISTICHE	
• rivestimento specifico nero opaco	
CONTENUTO	
• 1/4" F X 3/8" M, coppia massima 60 Nm	
• 3/8" F X 1/4" M, coppia massima 60 Nm	
• 3/8" F X 1/2" M, coppia massima 200 Nm	
• 1/2" F X 3/8" M, coppia massima 200 Nm	
• 1/2" F X 3/4" M, coppia massima 500 Nm	
• 3/4" F X 1/2" M, coppia massima 500 Nm	

BGS articolo	DESCRIZIONE	Euro
BGS 200-LEER	CASSETTA VUOTA	5,46





SPINE ACCIAIO PER BUSSOLE

Koken articolo	Ø	L mm	Box	Euro
1200 A	1/4"	10,2	1	0,44
1301 A	3/8"	14,5	1	0,44
1302 A	3/8"	17,5	1	0,44
1401 A	1/2"	20	1	0,74
1402 A	1/2"	25	1	0,74
1500 A	5/8"	30	1	0,74
1601 A	3/4"	35	1	0,83
1602 A	3/4"	45	1	0,94
1801 A	1"	45	1	0,94
1802 A	1"	75	1	1,82
1701 A	1 1/2"	75	1	1,98
1702 A	1 1/2"	110	1	3,99
1901 A	2 1/2"	110	1	4,46
1902 A	2 1/2"	155	1	5,06
2001 A	3 1/2"	155	1	8,36
2002 A	3 1/2"	180	1	6,90

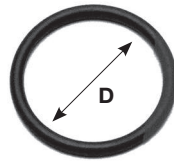

ANELLI DI GOMMA PER BUSSOLE

Koken articolo	Ø	D mm	Box	Euro
1200 B	1/4"	9	1	0,72
1301 B	3/8"	13	1	0,83
1302 B	3/8"	16	1	0,88
1401 B	1/2"	19	1	1,02
1402 B	1/2"	24	1	1,10
1500 B	5/8"	28	1	1,35
1601 B	3/4"	36	1	1,46
1602 B	3/4"	45	1	2,15
1801 B	1"	45	1	1,98
1802 B	1"	75	1	8,72
1701 B	1 1/2"	75	1	8,58
1702 B	1 1/2"	114	1	21,42
1901 B	2 1/2"	114	1	22,25
1902 B	2 1/2"	158	1	27,72
2001 B	3 1/2"	158	1	82,80
2002 B	3 1/2"	183	1	91,88



CHIAVI A BUSSOLA GUIDATE ANTI VIBRAZIONI BOCCA ESAGONALE

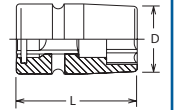

Koken articolo	Ø mm	D mm	L mm	Box	Euro
NV16400M-17	17	30	65	1	52,88
NV16400M-18	18	31.3	65	1	52,88
NV16400M-19	19	32.5	65	1	52,88
NV16400M-21	21	35	65	1	52,88
NV16400M-22	22	36.3	65	1	52,88
NV16400M-23	23	37.5	65	1	52,88
NV16400M-24	24	38.8	65	1	52,88
NV16400M-26	26	41.3	65	1	52,88
NV16400M-27	27	42.5	65	1	52,88
NV16400M-28	28	43.8	68	1	52,88
NV16400M-29	29	45	68	1	52,88
NV16400M-30	30	46.3	68	1	52,88
NV16400M-32	32	48.8	70	1	57,50
NV16400M-33	33	50	70	1	61,99
NV16400M-34	34	51.3	70	1	62,04
NV16400M-35	35	52.5	70	1	62,04
NV16400M-36	36	53.8	70	1	68,01
NV16400M-38	38	56.3	72	1	68,01
NV16400M-41	41	60	72	1	72,57
NV16400M-46	46	66.3	77	1	84,01
NV16400M-50	50	69	77	1	87,75



ESTRATTORE PER MOLLE DI SICUREZZA

Koken articolo	Ø	Box	Euro
149	3/8" - 1/2"	1	1,57
152	3/4" - 1"	1	1,68

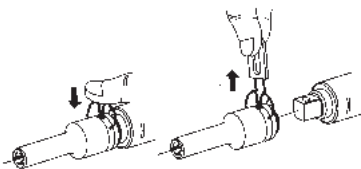
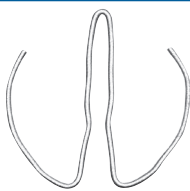

MOLLA DI SICUREZZA PER BUSSOLE

Koken articolo	Ø	Ø	Box	Euro
1301C	3/8"	≤12	1	0,94
1302C	3/8"	>12	1	0,94
1401C	1/2"	≤14	1	1,18
1402C	1/2"	>14	1	1,18
1600C	3/4"	≤46	1	2,26
1801C	1"	≤70	1	2,23
1802C	1"	>70	1	7,87
1700C	1 1/2"	≤90	1	8,22

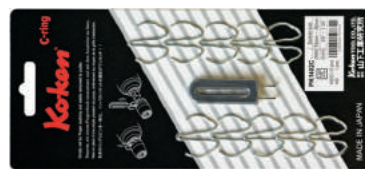

SET MOLLE DI SICUREZZA PER BUSSOLE

Koken articolo	nr.	Box	Euro
PK1301 C-10	10	149	13,92
PK1302 C-10	10	149	13,92
PK1401 C-10	10	149	16,86
PK1402 C-10	10	149	16,86
PK1600 C-10	10	149	25,82
PK1801 C-10	10	149	26,32



PROLUNGA ANTI VIBRAZIONI

Koken articolo	D mm	L mm	Box	Euro
NV16760-175	44	175	1	86,02
NV16760-250	44	250	1	92,65
NV16760-330	44	330	1	103,24

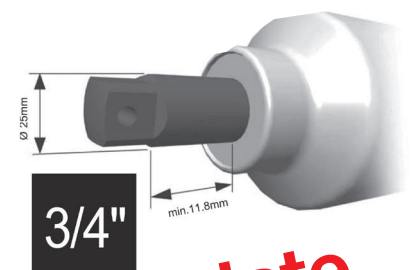

Guidate antivibrazioni

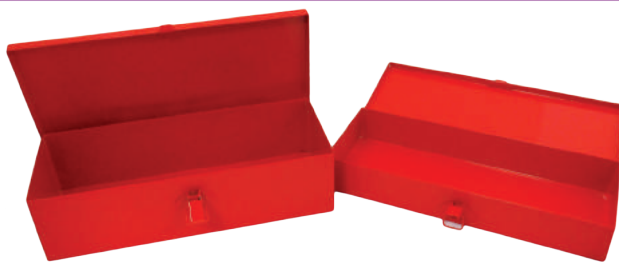

CASSETTE METALLICHE PORTA-BUSSOLE

FERMEC articolo	Dimensioni (lunghezza x larghezza x altezza) mm		Euro
CASS-2510	280 x 100 x 40 mm	1	26,25
CASS-3112	310 x 120 x 80 mm	1	39,90
CASS-3211	320 x 115 x 50 mm	1	42,00
CASS-6213	610 x 130 x 85 mm	1	55,00

NOTE

- a richiesta assortimento di bussole a macchina in cassetta metallica

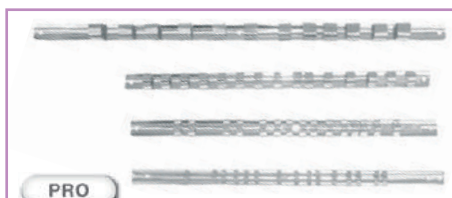

PRO

GUIDE PORTA BUSSOLE CON CLIP

BG articolo	Numero Clip	Euro
BGS 2316 1/4"	7	2,93
BGS 2317 3/8"	7	3,19
BGS 2318 1/2"	7	3,32
BGS 2120 1/4"	15	4,08
BGS 2330 3/8"	15	4,59
BGS 2540 1/2"	15	4,46
BGS 3460 3/4"	12	8,93

CARATTERISTICHE

- cromato satinato

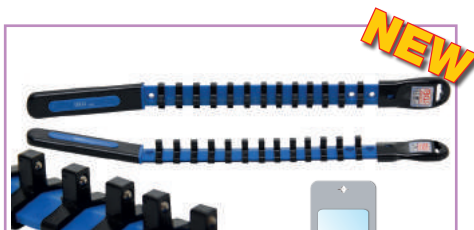

NEW

GUIDE PORTA BUSSOLE CON CLIP

BG articolo	Numero Clip	Euro
BGS 9193 1/4"	13	3,83
BGS 9194 3/8"	11	4,08
BGS 9195 1/2"	9	4,34

CARATTERISTICHE

- clip con sfere di tenuta



GUIDE MAGNETICHE PORTA BUSSOLE CON CLIP



Koken articolo	Nr. Clip	L mm		Euro
RSAL200-1/4x12	12	200	1	37,68
RSAL200-3/8x8	8	200	1	35,56
RSAL300-3/8x12	12	300	1	42,90
RSAL300-1/2x10	10	300	1	44,85



GUIDE PORTA BUSSOLE PER MOLLE IN ACCIAIO DA 1/4" - 3/8" - 1/2" - 3/4"

Koken articolo	L mm		Euro
R 158	158	1	2,52
R 251	251	1	2,56
R 300	300	1	2,62
R 400	400	1	2,71



NEW

GUIDE MAGNETICHE PORTA BUSSOLE CON CLIP

BG articolo	Numero Clip	L mm	Euro
BGS 9342 1/4"	12	310	22,19
BGS 9343 3/8"	12	310	22,44
BGS 9344 1/2"	12	310	22,70

CARATTERISTICHE

- clip con sfera per bussole realizzate in plastica rinforzata
- magneti rivestiti in gomma protettiva



GUIDE PORTA BUSSOLE MAGNETICHE PER MOLLE IN PLASTICA





Koken articolo	L mm		Euro
RSAL-200	200	1	31,54
RSAL-300	300	1	36,63



MOLLE IN ACCIAIO PER GUIDE

Koken articolo	Euro
C 14 1/4"	0,34
C 38 3/8"	0,34
C 12 1/2"	0,34
C 34 3/4"	0,50



MOLLE IN PLASTICA PER GUIDE

Koken articolo			Euro
CLIP-1/4	1/4"	1	0,55
CLIP-3/8	3/8"	1	0,55
CLIP-1/2	1/2"	1	0,55

**GUIDA MAGNETICA PER MOLLE PORTA
BUSSOLE DA 1/4" - 3/8" - 1/2" - 3/4"**

FERMEC articolo	L mm		Euro
MAG300	300	1	20,50

BARRA PORTABUSSOLE MAGNETICA,

BGS articolo		Numero vani	Euro
BGS 3011-1	1/4"	10	5,36
BGS 3011-2	3/8"	12	8,16
BGS 3011-3	1/2"	10	11,09

CARATTERISTICHE

- le bussole sono trattenute grazie ad una banda magnetica



1/4" 3/8" 1/2" 3/4" 1"

CLIP X ATTACCO QUADRO FEMMINA

BGS articolo		Euro
BGS HANGER-1	1/4"	1,91
BGS HANGER-2	3/8"	1,91
BGS HANGER-3	1/2"	1,91
BGS HANGER-4	3/4"	2,04
BGS HANGER-5	1"	2,04

CARATTERISTICHE

- clip in plastica con quadro maschio
- ad esempio per esposizione bussole

NOTE



CHIAVI A BUSSOLA
A MANO BOCCA
ESAGONALE

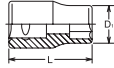

POLLICI





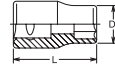

CHIAVI A BUSSOLA
A MANO BOCCA
ESAGONALE

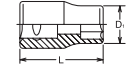



CHIAVI A BUSSOLA
A MANO BOCCA
POLIGONALE



Koken articolo	 mm	D mm	L mm		Euro
8400M-24	24	36.5	60	1	37,24
8400M-27	27	40.5	60	1	37,24
NEW 8400M-28	28	41.5	60	1	37,24
NEW 8400M-29	29	43	60	1	37,24
8400M-30	30	44	65	1	37,24
8400M-32	32	46.5	65	1	37,24
8400M-33	33	48	65	1	37,24
NEW 8400M-34	34	49	60	1	37,24
8400M-35	35	50.5	65	1	37,24
8400M-36	36	51.5	65	1	37,68
8400M-38	38	54	65	1	37,68
8400M-40	40	56.5	65	1	37,68
8400M-41	41	58	68	1	44,63
8400M-42	42	59	68	1	45,24
8400M-46	46	64	72	1	48,90
8400M-50	50	69	72	1	54,53
8400M-54	54	74	72	1	64,76
8400M-55	55	75.5	77	1	67,71
NEW 8400M-56	56	76.5	60	1	73,73
8400M-58	58	79	77	1	73,73
8400M-60	60	81.5	82	1	80,05
8400M-63	63	85.5	82	1	91,38
8400M-65	65	88	86	1	95,73
8400M-67	67	90.5	86	1	103,79
8400M-68	68	91.5	86	1	107,33
8400M-70	70	94	88	1	113,85
8400M-71	71	95.5	88	1	127,63
8400M-75	75	100.5	90	1	139,73
NEW 8400M-78	78	104	60	1	151,69
8400M-80	80	106.5	95	1	151,69
8400M-83	83	110.5	95	1	160,52
8400M-85	85	113	95	1	160,52
8400M-90	90	119	100	1	227,29
8400M-95	95	125.5	100	1	260,34
8400M-100	100	131.5	100	1	268,13

Koken articolo	 pollici	D mm	L mm		Euro
8400A-15/16	15/16"	36.5	60	1	40,12
8400A-1-3/16	1-3/16"	44	65	1	40,12
8400A-1-1/4	1-1/4"	46.5	65	1	40,12
8400A-1-5/16	1-5/16"	48	65	1	40,12
8400A-1-3/8	1-3/8"	50.5	65	1	40,12
8400A-1-7/16	1-7/16"	53	65	1	40,59
8400A-1-1/2	1-1/2"	54	65	1	40,59
8400A-1-9/16	1-9/16"	56.5	65	1	40,59
8400A-1-5/8	1-5/8"	58	68	1	48,13
8400A-1-11/16	1-11/16"	60.5	68	1	52,72
8400A-1-3/4	1-3/4"	61.5	68	1	52,72
8400A-1-13/16	1-13/16"	64	72	1	52,72
8400A-1-7/8	1-7/8"	66.5	72	1	58,66
8400A-1-15/16	1-15/16"	68	72	1	58,66
8400A-2	2"	70.5	72	1	58,91
8400A-2-1/16	2-1/16"	73	72	1	58,91
8400A-2-1/8	2-1/8"	74	72	1	69,80
8400A-2-3/16	2-3/16"	76.5	77	1	73,48
8400A-2-1/4	2-1/4"	78	77	1	79,45
8400A-2-5/16	2-5/16"	80.5	77	1	79,45
8400A-2-3/8	2-3/8"	81.5	82	1	86,30
8400A-2-7/16	2-7/16"	84	82	1	86,30
8400A-2-1/2	2-1/2"	86.5	82	1	103,13
8400A-2-9/16	2-9/16"	88	86	1	103,13
8400A-2-5/8	2-5/8"	90.5	86	1	111,82
8400A-2-11/16	2-11/16"	91.5	86	1	112,94
8400A-2-3/4	2-3/4"	94	88	1	122,65
8400A-2-13/16	2-13/16"	96.5	88	1	137,53
8400A-2-7/8	2-7/8"	98	88	1	137,53
8400A-2-15/16	2-15/16"	100.5	90	1	150,59
8400A-3	3"	103	90	1	163,46
8400A-3-1/8	3-1/8"	106.5	95	1	163,46
8400A-3-1/4	3-1/4"	110.5	95	1	163,46
8400A-3-3/8	3-3/8"	114	95	1	173,00
8400A-3-1/2	3-1/2"	119	100	1	244,92
8400A-3-3/4	3-3/4"	125.5	100	1	280,53

Koken articolo	 mm	D mm	L mm		Euro
8405M-24	24	36.5	60	1	37,24
8405M-27	27	40.5	60	1	37,24
NEW 8405M-28	28	41.5	60	1	37,24
NEW 8405M-29	29	43	60	1	37,24
8405M-30	30	44	65	1	37,24
8405M-32	32	46.5	65	1	37,24
8405M-33	33	48	65	1	37,24
NEW 8405M-34	34	49	65	1	37,24
8405M-35	35	50.5	65	1	37,24
8405M-36	36	51.5	65	1	37,68
8405M-38	38	54	65	1	37,68
8405M-40	40	56.5	65	1	37,68
8405M-41	41	58	68	1	44,63
8405M-42	42	59	68	1	45,24
8405M-46	46	64	72	1	48,90
8405M-50	50	69	72	1	54,53
8405M-54	54	74	72	1	64,76
8405M-55	55	75.5	77	1	67,71
NEW 8405M-56	56	76.5	77	1	73,73
8405M-58	58	79	77	1	73,73
8405M-60	60	81.5	82	1	80,05
8405M-63	63	85.5	82	1	91,38
8405M-65	65	88	86	1	95,73
8405M-67	67	90.5	86	1	103,79
8405M-68	68	91.5	86	1	107,33
8405M-70	70	94	88	1	113,85
8405M-71	71	95.5	88	1	127,63
8405M-75	75	100.5	90	1	139,73
NEW 8405M-78	78	104	90	1	151,69
8405M-80	80	106.5	95	1	151,69
8405M-83	83	110.5	95	1	160,52
8405M-85	85	113	95	1	160,52
8405M-90	90	119	100	1	227,29
8405M-95	95	125.5	100	1	260,34
8405M-100	100	131.5	100	1	271,92

KOKEN 1"



POLLICI



POLIGONALE

CHIAVI A BUSSOLA
A MANO BOCCA
POLIGONALE

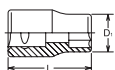

Koken articolo	pollici	D mm	L mm		Euro
8405A-15/16	15/16"	36.5	60	1	40,12
8405A-1-3/16	1-3/16"	44	65	1	40,12
8405A-1-1/4	1-1/4"	46.5	65	1	40,12
8405A-1-5/16	1-5/16"	48	65	1	40,12
8405A-1-3/8	1-3/8"	50.5	65	1	40,12
8405A-1-7/16	1-7/16"	53	65	1	40,59
8405A-1-1/2	1-1/2"	54	65	1	40,59
8405A-1-9/16	1-9/16"	56.5	65	1	40,59
8405A-1-5/8	1-5/8"	58	68	1	48,13
8405A-1-11/16	1-11/16"	60.5	68	1	52,72
8405A-1-3/4	1-3/4"	61.5	68	1	52,72
8405A-1-13/16	1-13/16"	64	72	1	52,72
8405A-1-7/8	1-7/8"	66.5	72	1	58,66
8405A-1-15/16	1-15/16"	68	72	1	58,66
8405A-2	2"	70.5	72	1	58,91
8405A-2-1/16	2-1/16"	73	72	1	58,91
8405A-2-1/8	2-1/8"	74	72	1	69,80
8405A-2-3/16	2-3/16"	76.5	77	1	73,48
8405A-2-1/4	2-1/4"	78	77	1	79,45
8405A-2-5/16	2-5/16"	80.5	77	1	79,45
8405A-2-3/8	2-3/8"	81.5	82	1	86,30
8405A-2-7/16	2-7/16"	84	82	1	86,30
8405A-2-1/2	2-1/2"	86.5	82	1	103,13
8405A-2-9/16	2-9/16"	88	86	1	103,13
8405A-2-5/8	2-5/8"	90.5	86	1	111,82
8405A-2-11/16	2-11/16"	91.5	86	1	115,61
8405A-2-3/4	2-3/4"	94	88	1	122,65
8405A-2-13/16	2-13/16"	96.5	88	1	137,53
8405A-2-7/8	2-7/8"	98	88	1	137,53
8405A-2-15/16	2-15/16"	100.5	90	1	150,59
8405A-3	3"	103	90	1	163,46
8405A-3-1/8	3-1/8"	106.5	95	1	163,46
8405A-3-1/4	3-1/4"	110.5	95	1	163,46
8405A-3-3/8	3-3/8"	114	95	1	173,00
8405A-3-1/2	3-1/2"	119	100	1	244,92
8405A-3-3/4	3-3/4"	125.5	100	1	280,53



POLIGONALE

CHIAVI A
BUSSOLA
A MANO BOCCA
POLIGONALE
EXTRA LUNGA



Koken articolo	mm	D mm	L mm		Euro
8102M.400-32	32	48,5	400	1	162,94
8102M.400-33	33	49,8	400	1	162,94



ESAGONO

Koken articolo	DESCRIZIONE	Euro
8225M-00	Cassetta metallica 15 Pz. 600 x 217 x h 97 mm	1302,87
RICAMBI		
BUSSOLE	32, 33, 36, 41, 46, 50, 55, 60, 65, 70, 75, 80	
ESAGONO	8400M	
	8749	
ACCESSORI	8760-200	
	8760-400	



Koken articolo	DESCRIZIONE	Euro
8225M-05	Cassetta metallica 15 Pz. 600 x 217 x h 97 mm	1302,87
RICAMBI		
BUSSOLE	32, 33, 36, 41, 46, 50, 55, 60, 65, 70, 75, 80	
POLIGONALE	8405M	
	8749	
ACCESSORI	8760-200	
	8760-400	



ESAGONO

PER USO A MANO

CHIAVI A BUSSOLA
MASCHIO
ESAGONALE
INTEGRALE

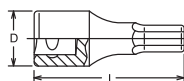

Koken articolo	mm	D mm	L mm		Euro
8012M-80-17	17	44.2	80	1	55,28
8012M-80-19	19	44.2	80	1	55,28
8012M-80-22	22	47.9	80	1	55,28
8012M-80-24	24	47.9	80	1	55,28
8012M-80-27	27	47.9	80	1	55,28
8012M-80-30	30	47.9	80	1	55,28
8012M-80-32	32	47.9	80	1	58,55
8012M-80-36	36	54.2	80	1	61,71



PROLUNGHE CON ATTACCO QUADRO

Koken articolo	D mm	L mm		Euro
8760-200	44	200	1	58,22
8760-400	44	400	1	86,52

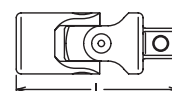

SNODO

Koken articolo	L mm		Euro
8770	143	1	116,46



1"

3/4"

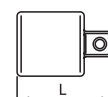

RACCORDO DI RIDUZIONE
QUADRO MASCHIO 3/4" E FEMMINA 1"

Koken articolo	L mm		Euro
8866A	60	1	25,44

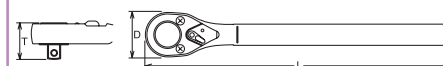

CRICCHETTO PORTABUSSOLA REVERSIBILE

Koken articolo	D mm	T mm	L mm		Euro
8749	70	62,2	800	1	225,89

MECCANISMO
36
DENTI



QUADRO MASCHIO SNODATO

Koken articolo	D mm	L mm		Euro
8768	55	600	1	193,11



QUADRO MASCHIO CON ASTA SCORREVOLE

Koken articolo	L mm		Euro
8785	550	1	117,98
NEW 8785-700	700	1	161,51



QUADRO MASCHIO AD ANGOLO

Koken articolo	L mm		Euro
8788	600	1	133,10

NOTE

Area for handwritten notes with horizontal dotted lines.



KOKEN 1"



PRO+



ESAGONO

BUSSOLE CHROM-VANADIUMAttacco: 1"
impronta: ESAGONO

BGS articolo	mm	L mm		Euro
BGS 3736	36	65	1	20,91
BGS 3741	41	70	1	23,46
BGS 3746	46	75	1	28,82
BGS 3750	50	75	1	31,62
BGS 3755	55	80	1	37,74
BGS 3760	60	85	1	43,10
BGS 3765	65	87	1	51,00
BGS 3770	70	90	1	59,93
BGS 3775	75	95	1	65,28
BGS 3780	80	100	1	71,40



PRO+



1"

PROLUNGHE

attacco: 1"

BGS articolo	L mm		Euro
BGS 372	200	1	51,77
BGS 374	400	1	65,03



PRO+



BGS 300-1

BGS 300-RPAIR

**CHIAVE A CRICCHETTO
REVERSIBILE EXTRA
LUNGA**

BGS 300

118,58

CARATTERISTICHE

- lunghezza da 550 mm

RICAMBI

BGS articolo	DESCRIZIONE	Euro
BGS 300-1	LEVA DI MANOVRA	45,77
BGS 300-REPAIR	KIT DI RIPARAZIONE	75,23

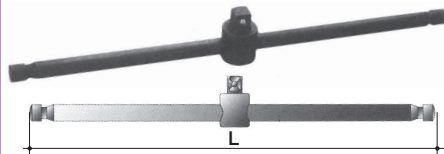
**LEVA CON QUADRO SCORREVOLE "POWER IMPACT" BRUNITA**

Attacco: 1"

BGS articolo	1"	L mm		Euro
755050	1"	760	1	99,75



PRO+



BGS 375

**LEVA CON QUADRO
SCORREVOLE, ATT. 1"**

75,23

CARATTERISTICHE

- modello ad alta resistenza
- lunghezza 560 mm
- Ø 28 mm



BGS 377



PRO+



BGS 376

**IMPUGNATURA
SNODATA LUNGH.
1000 MM, ATT. 1"**

123,68

CARATTERISTICHE

- lunghezza 1000 mm
- cromata lucida
- alta resistenza
- coppia massima 2400 Nm

RICAMBI

BGS articolo	DESCRIZIONE	Euro
BGS 377	KIT DI RIPARAZIONE TESTA SNODATA	41,57



PRO+



CV



BGS 206

DESCRIZIONE
**ADATTATORE
SCORREVOLE PER
BARRE ATT. 1"**

Euro

28,82

CARATTERISTICHE

- cromata, satinata
- per impiego con prolungha
- foro Ø 28,5 mm



PRO+



ESAGONO



BGS 1210

DESCRIZIONE
**SET 15 PEZZI,
BUSSOLE ATT. 1"**

Euro

799,88

CARATTERISTICHE

- cricchetto reversibile a 24 denti, lungh. 680 mm
- 2 prolungha: 200 mm + 400 mm
- leva a "T" con quadro scorrevole da 500 mm
- 10 bussole esagonali: 36-41-46-50-55-60-65-70-75-80 mm

RICAMBI

BGS articolo	DESCRIZIONE	Euro
BGS 1210-LEER	CASSETTA VUOTA	110,93



ESAGONO



BGS 15111

DESCRIZIONE
**SET 15 PEZZI,
BUSSOLE DA 1",
36 - 80 MM**

Euro

507,00

CARATTERISTICHE

- cricchetto
- leva a T con quadro scorrevole
- barra di prolungha da 200 mm
- barra di prolungha da 450 mm
- bussole esagonali : 36 - 41 - 46 - 50 - 55 - 60 - 65 - 70 - 75 - 80 mm
- in cassetta metallica



BUSSOLE "POWER IMPACT"

attacco: 1"

impronta: ESAGONO

FEIMEC articolo	mm	L mm		Euro
1991-17	17	58	1	30,45
1991-19	19	58	1	30,45
1991-20	20	58	1	30,45
1991-21	21	58	1	30,45
1991-22	22	58	1	30,45
1991-23	23	58	1	30,45
1991-24	24	58	1	30,45
1991-25	25	58	1	30,45
1991-26	26	58	1	30,45
1991-27	27	58	1	30,45
1991-28	28	58	1	30,45
1991-29	29	60	1	30,45
1991-30	30	60	1	30,45
1991-31	31	60	1	30,45
1991-32	32	63	1	30,45
1991-33	33	63	1	30,45
1991-34	34	65	1	32,14
1991-35	35	65	1	32,14
1991-36	36	67	1	33,60
1991-37	37	67	1	34,04
1991-38	38	67	1	38,58
1991-39	39	67	1	38,58
1991-40	40	67	1	38,58
1991-41	41	67	1	39,90
1991-42	42	74	1	42,74
1991-43	43	74	1	42,74
1991-44	44	74	1	42,74
1991-45	45	74	1	42,74
1991-46	46	74	1	46,20
1991-47	47	74	1	47,90
1991-48	48	74	1	47,90
1991-50	50	80	1	48,95
1991-52	52	80	1	60,14
1991-54	54	80	1	60,64
1991-55	55	76	1	60,90
1991-56	56	76	1	63,00
1991-58	58	79	1	63,00
1991-60	60	82	1	66,15
1991-65	65	85	1	72,45
1991-70	70	88	1	84,00
1991-75	75	92	1	89,78
1991-77	77	97	1	99,75
1991-80	80	97	1	110,25
1991-85	85	100	1	131,25
1991-90	90	104	1	157,50
1991-95	95	106	1	204,75
1991-100	100	112	1	257,25
1991-105	105	112	1	304,50
1991-110	110	122	1	325,36
1991-115	115	122	1	373,49



BUSSOLE "POWER IMPACT" ECONOMICHE

attacco: 1"

impronta: ESAGONO

BGS articolo	mm	L mm		Euro
BGS 5827	27	58	1	22,95
BGS 5830	30	60	1	25,25
BGS 5832	32	63	1	26,01
BGS 5833	33	63	1	27,03
BGS 5834	34	65	1	27,29
BGS 5835	35	65	1	27,29
BGS 5836	36	67	1	27,54
BGS 5838	38	67	1	28,05
BGS 5839 NEW	39	67	1	28,82
BGS 5841	41	67	1	29,58
BGS 5846	46	74	1	36,21
BGS 5850	50	80	1	42,08
BGS 5855	55	76	1	51,00
BGS 5856	56	76	1	66,30
BGS 5860	60	82	1	68,85
BGS 5865	65	85	1	75,23
BGS 5870	70	88	1	85,43
BGS 5875 NEW	75	96	1	104,55
BGS 5880 NEW	80	96	1	124,95
BGS 5885 NEW	85	100	1	172,50
BGS 5890 NEW	90	106	1	197,50
BGS 5895 NEW	95	106	1	247,50
BGS 5905 NEW	105	106	1	322,50
BGS 5910 NEW	110	106	1	347,50
BGS 5915 NEW	115	106	1	372,50
BGS 5920 NEW	120	106	1	397,50

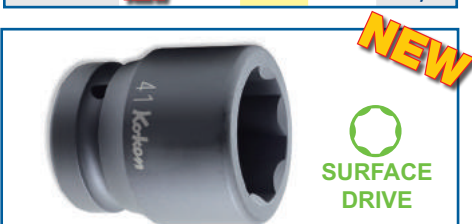

CHIAVI A BUSSOLA A MACCHINA BOCCA SURFACE DRIVE

Koken articolo	mm	D mm	L mm		Euro
18410M-24	24	41,5	57	1	41,42
18410M-27	27	45,3	57	1	41,42
18410M-30	30	49	62	1	41,42
18410M-32	32	51,5	62	1	41,42
18410M-33	33	52,8	62	1	41,42
18410M-36	36	56,5	62	1	44,30
18410M-41	41	62,8	62	1	55,77



CASSETTA METALLICA PZ. 8 BUSSOLE 1" 24 - 27 - 30 - 32 - 33 - 36 - 38 - 41 MM

attacco: 1"
impronta: ESAGONO

FEIMEC articolo	Descrizione		Euro
199128	CASSETTA METALLICA 8 PEZZI	1	210,00



SET 8 PEZZI BUSSOLE A MACCHINA

BGS articolo	DESCRIZIONE	Euro
BGS 5245	SET 8 PEZZI BUSSOLE A MACCHINA	233,75

CARATTERISTICHE

- finitura fosfatata
- con scanalatura e foro per spina
- 27-30-32-36-38-41-46-50 mm
- in cassetta metallica

RICAMBI

BGS articolo	DESCRIZIONE	Euro
BGS 5245-LEER	CASSETTA VUOTA	30,60

PARETI SOTTILI



CHIAVI A BUSSOLA
A MACCHINA
BOCCA ESAGONALE
PARETI SOTTILI

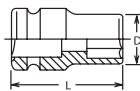

Koken articolo	mm	D mm	L mm	€uro
18401M-17	17	29.8	57	39,74
18401M-18	18	31	57	39,74
18401M-19	19	32.3	57	39,74
18401M-20	20	33.5	57	39,74
18401M-21	21	34.8	57	39,74
18401M-22	22	36	57	39,74
18401M-24	24	38.5	57	39,74
18401M-26	26	41	70	39,74
18401M-27	27	42.3	57	39,74
18401M-29	29	44.8	57	39,74
18401M-30	30	46	62	39,74
18401M-32	32	48.5	62	39,74
18401M-33	33	49.8	62	39,74
18401M-35	35	52.3	62	39,74
18401M-36	36	53.5	62	41,44
18401M-38	38	56	66	47,30
18401M-41	41	59.8	66	51,92
18401M-42	42	61	66	52,55
18401M-46	46	66	70	55,00
18401M-47	47	67.3	70	60,61
18401M-50	50	71	70	71,36



CHIAVI A BUSSOLA
A MACCHINA
BOCCA ESAGONALE

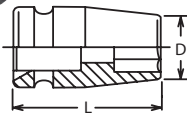

Koken articolo	mm	D mm	L mm	€uro
18400M-17	17	32.8	57	38,72
18400M-18	18	34	57	38,72
18400M-19	19	35.3	57	38,72
18400M-21	21	37.8	57	38,72
18400M-22	22	39	57	38,72
18400M-23	23	40.3	57	38,72
18400M-24	24	41.5	57	38,72
18400M-25	25	42.8	57	38,72
18400M-26	26	44	57	38,72
18400M-27	27	45.3	57	38,72
18400M-28	28	46.5	57	38,72
18400M-29	29	47.8	57	38,72
18400M-30	30	49	62	38,72
18400M-31	31	50.3	62	38,72
18400M-32	32	51.5	62	38,72
18400M-33	33	52.8	62	38,72
18400M-34	34	54	62	38,72
18400M-35	35	55.3	62	38,72
18400M-36	36	56.5	62	40,40
18400M-37	37	57.8	62	41,44
18400M-38	38	59	66	46,09
18400M-39	39	60.3	66	47,03
18400M-40	40	61.5	66	47,03
18400M-41	41	62.8	66	50,57
18400M-42	42	64	66	51,21
18400M-43	43	65.3	68	52,47
18400M-44	44	66.5	68	52,47
18400M-45	45	67.8	68	52,47
18400M-46	46	69	70	53,60
18400M-47	47	70.3	70	59,07
18400M-48	48	71.5	70	59,07
18400M-50	50	74	70	69,55
18400M-52	52	76.5	75	74,09
18400M-54	54	79	75	74,33
18400M-55	55	80.3	75	77,06
18400M-56	56	81.5	75	77,06
18400M-58	58	84	75	77,06
18400M-60	60	86.5	75	91,38
18400M-62	62	89	75	93,50
18400M-63	63	90.3	75	104,03
18400M-65	65	92.8	75	104,36
18400M-67	67	95.3	75	116,05
18400M-68	68	96.5	75	116,05
18400M-70	70	99	75	118,36
18400M-75	75	105.3	80	150,37
18400M-77	77	107.8	80	158,90
18400M-80	80	111.5	85	158,90
18400M-85	85	117.8	90	199,62
18400M-90	90	124	95	259,13
18400M-95	95	130.3	100	333,19
18400M-100	95	136.5	105	420,97

POLLICI



CHIAVI A BUSSOLA
A MACCHINA
BOCCA ESAGONALE

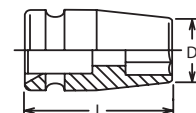

Koken articolo	pollici	D mm	L mm	€uro
18400A-11/16	11/16"	32.8	57	41,72
18400A-3/4	3/4"	35.3	57	41,72
18400A-13/16	13/16"	37.8	57	41,72
18400A-7/8	7/8"	39	57	41,72
18400A-15/16	15/16"	41.5	57	41,72
18400A-1	1"	42.8	57	41,72
18400A-1-1/16	1-1/16"	45.3	57	41,72
18400A-1-1/8	1-1/8"	47.8	57	41,72
18400A-1-3/16	1-3/16"	49	62	41,72
18400A-1-1/4	1-1/4"	51.5	62	41,72
18400A-1-5/16	1-5/16"	54	62	41,72
18400A-1-3/8	1-3/8"	55.3	62	41,72
18400A-1-7/16	1-7/16"	57.8	62	44,61
18400A-1-1/2	1-1/2"	59	66	49,67
18400A-1-9/16	1-9/16"	61.5	66	50,66
18400A-1-5/8	1-5/8"	62.8	66	54,53
18400A-1-11/16	1-11/16"	65.3	68	56,57
18400A-1-3/4	1-3/4"	67.8	68	56,57
18400A-1-13/16	1-13/16"	69	70	57,75
18400A-1-7/8	1-7/8"	71.5	70	63,64
18400A-1-15/16	1-15/16"	72.8	70	67,51
18400A-2	2"	75.3	70	77,96
18400A-2-1/16	2-1/16"	76.5	75	79,81
18400A-2-1/8	2-1/8"	79	75	80,08
18400A-2-3/16	2-3/16"	80.3	75	83,02
18400A-2-1/4	2-1/4"	82.8	75	83,02
18400A-2-5/16	2-5/16"	84	75	83,02
18400A-2-3/8	2-3/8"	86.5	75	98,45
18400A-2-7/16	2-7/16"	89	75	100,79
18400A-2-1/2	2-1/2"	91.5	75	112,09
18400A-2-9/16	2-9/16"	92.8	75	112,48
18400A-2-5/8	2-5/8"	95.3	75	125,04
18400A-2-11/16	2-11/16"	96.5	75	125,04
18400A-2-3/4	2-3/4"	99	75	127,57
18400A-2-13/16	2-13/16"	101.5	75	142,29
18400A-2-7/8	2-7/8"	102.8	80	142,29
18400A-2-15/16	2-15/16"	105.3	80	162,00
18400A-3	3"	106.5	80	171,22
18400A-3-1/16	3-1/16"	109	85	171,22
18400A-3-1/8	3-1/8"	111.5	85	171,22
18400A-3-1/4	3-1/4"	115.3	90	171,22
18400A-3-3/8	3-3/8"	119	90	221,27
18400A-3-1/2	3-1/2"	124	95	279,24
18400A-3-3/4	3-3/4"	130.33	100	359,01
18400A-3-7/8	3-7/8"	135.3	105	453,67
18400A-4	4"	137.8	105	453,67

IMPACT 1"



POLLICI



1"

ESAGONO

MISURE IN POLLICI - A RICHIESTA ALTRE MISURE

attacco: 1"

impronta: ESAGONO

FEFMEC articolo	pollici	L mm		Euro
1991-7/8	7/8"	55	1	39,75
1991-15/16	15/16"	55	1	39,75
1991-1	1"	55	1	39,75
1991-1-1/8	1-1/8"	57	1	39,75
1991-1-1/4	1-1/4"	57	1	39,75
1991-1-5/16	1-5/16"	60	1	39,75
1991-1-7/16	1-7/16"	60	1	42,60
1991-1-9/16	1-9/16"	64	1	44,77
1991-1-5/8	1-5/8"	69	1	49,01
1991-1-11/16	1-11/16"	69	1	49,01
1991-1-3/4	1-3/4"	69	1	49,01
1991-1-7/8	1-7/8"	72	1	55,98
1991-1-15/16	1-15/16"	72	1	55,98
1991-2	2"	72	1	68,73
1991-2-1/16	2-1/16"	80	1	68,73
1991-2-3/16	2-3/16"	80	1	72,99
1991-2-1/4	2-1/4"	80	1	72,99
1991-2-5/16	2-5/16"	85	1	72,99
1991-2-3/8	2-3/8"	85	1	87,50
1991-2-7/16	2-7/16"	85	1	87,50
1991-2-1/2	2-1/2"	85	1	98,75
1991-2-5/8	2-5/8"	91	1	114,87
1991-2-11/16	2-11/16"	91	1	114,87
1991-2-13/16	2-13/16"	92	1	128,82
1991-2-7/8	2-7/8"	92	1	128,82
1991-3	3"	97	1	140,92
1991-3-1/16	3-1/16"	100	1	140,92
1991-3-1/8	3-1/8"	100	1	158,67
1991-3-3/16	3-3/16"	100	1	158,67
1991-3-1/4	3-1/4"	100	1	199,67
1991-3-5/16	3-5/16"	100	1	221,50
1991-3-3/8	3-3/8"	104	1	231,00
1991-3-7/16	3-7/16"	104	1	241,50
1991-3-1/2	3-1/2"	104	1	256,38
1991-3-9/16	3-9/16"	104	1	261,45
1991-3-5/8	3-5/8"	104	1	263,55
1991-3-11/16	3-11/16"	104	1	263,55
1991-3-13/16	3-13/16"	112	1	263,55
1991-3-7/8	3-7/8"	112	1	263,55
1991-4	4"	112	1	304,50



1"

POLIGONALE

POLIGONALI

attacco: 1"

impronta: POLIGONALE

FEFMEC articolo	mm	L mm		Euro
1991-19 DSKT	19	55	1	37,80
1991-20 DSKT	20	55	1	37,80
1991-21 DSKT	21	55	1	37,80
1991-22 DSKT	22	55	1	37,80
1991-24 DSKT	24	55	1	40,65
1991-25 DSKT	25	55	1	40,65
1991-26 DSKT	26	55	1	40,65
1991-27 DSKT	27	55	1	40,65
1991-30 DSKT	30	57	1	40,65
1991-32 DSKT	32	57	1	40,65
1991-33 DSKT	33	57	1	40,65
1991-35 DSKT	35	60	1	40,65
1991-36 DSKT	36	60	1	45,15
1991-38 DSKT	38	64	1	45,15
1991-40 DSKT	40	64	1	52,50
1991-41 DSKT	41	64	1	53,13
1991-46 DSKT	46	64	1	59,85
1991-47 DSKT	47	64	1	64,05
1991-50 DSKT	50	67	1	72,99
1991-54 DSKT	54	71	1	89,25
1991-55 DSKT	55	71	1	88,20
1991-58 DSKT	58	75	1	98,70
1991-60 DSKT	60	80	1	115,50
1991-65 DSKT	65	85	1	149,10
1991-70 DSKT	70	88	1	166,95
1991-75 DSKT	75	100	1	215,25
1991-80 DSKT	80	100	1	279,30
1991-85 DSKT	85	100	1	294,00
1991-90 DSKT	90	104	1	299,25
1991-95 DSKT	95	106	1	344,40
1991-100 DSKT	100	112	1	378,00
1991-105 DSKT	105	112	1	416,85
1991-110 DSKT	110	122	1	491,40
1991-115 DSKT	115	122	1	562,80



POLIGONALE

CHIAVI A BUSSOLA
A MACCHINA
BOCCA POLIGONALE

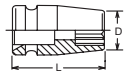

Kokon articolo	mm	D mm	L mm		€uro
18405M-24	24	41.5	57	1	40,65
18405M-27	27	45.3	57	1	40,65
18405M-30	30	49	62	1	40,65
18405M-32	32	51.5	62	1	40,65
18405M-33	33	52.8	62	1	40,65
18405M-35	35	55.3	62	1	40,65
18405M-36	36	56.5	62	1	42,38
18405M-38	38	59	66	1	48,37
18405M-40	40	62.8	66	1	49,36
18405M-41	41	61.5	66	1	53,13
18405M-46	46	69	70	1	56,27
18405M-50	50	74	70	1	72,99
18405M-55	55	80.3	75	1	80,88
18405M-56	56	81.5	75	1	80,88
18405M-60	60	86.5	75	1	95,92
18405M-65	65	92.8	75	1	109,59
18405M-70	70	99	75	1	124,30
18405M-75	75	105.3	80	1	157,85
18405M-80	80	111.5	85	1	166,84



POLIGONALE

CHIAVI A BUSSOLA
A MACCHINA
BOCCA POLIGONALE
RIBASSATE

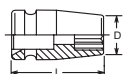

Kokon articolo	mm	D mm	L mm		€uro
18405M-50(D68)	50	68	75	1	80,30
18405M-55(D76)	55	76	75	1	87,95
18405M-65(D87)	65	87	75	1	117,92

IMPACT 1"

POLLICI



POLIGONALE

MISURE IN POLLICI

attacco: 1"

impronta: POLIGONALE

FEEMEC articolo	pollici	L mm		Euro
1991-3/4 DSKT	3/4"	55	1	45,15
1991-13/16 DSKT	13/16"	55	1	45,15
1991-7/8 DSKT	7/8"	55	1	45,15
1991-15/16 DSKT	15/16"	55	1	45,15
1991-1 DSKT	1"	55	1	45,15
1991-1-1/8 DSKT	1-1/8"	57	1	45,15
1991-1-13/16 DSKT	1-13/16"	57	1	45,15
1991-1-1/4 DSKT	1-1/4"	57	1	45,15
1991-1-5/16 DSKT	1-5/16"	60	1	45,15
1991-1-7/16 DSKT	1-7/16"	60	1	48,30
1991-1-1/2 DSKT	1-1/2"	60	1	51,45
1991-1-9/16 DSKT	1-9/16"	64	1	52,50
1991-1-11/16 DSKT	1-11/16"	69	1	57,75
1991-1-3/4 DSKT	1-3/4"	69	1	57,75
1991-1-7/8 DSKT	1-7/8"	69	1	64,05
1991-1-15/16 DSKT	1-15/16"	72	1	68,25
1991-2 DSKT	2"	72	1	73,50
1991-2-1/16 DSKT	2-1/16"	72	1	84,00
1991-2-1/8 DSKT	2-1/8"	76	1	89,25
1991-2-3/16 DSKT	2-3/16"	76	1	94,50
1991-2-1/4 DSKT	2-1/4"	80	1	95,55
1991-2-5/16 DSKT	2-5/16"	80	1	95,55
1991-2-3/8 DSKT	2-3/8"	85	1	116,55
1991-2-7/16 DSKT	2-7/16"	85	1	130,20
1991-2-1/2 DSKT	2-1/2"	85	1	139,65
1991-2-5/8 DSKT	2-5/8"	88	1	156,87
1991-2-11/16 DSKT	2-11/16"	88	1	166,95
1991-2-13/16 DSKT	2-13/16"	92	1	166,95
1991-2-7/8 DSKT	2-7/8"	92	1	194,25
1991-3 DSKT	3"	97	1	215,25
1991-3-1/16 DSKT	3"-1/16"	97	1	228,90
1991-3-1/8 DSKT	3"-1/8"	97	1	228,90
1991-3-3/16 DSKT	3"-3/16"	100	1	280,35
1991-3-1/4 DSKT	3"-1/4"	100	1	295,05
1991-3-5/16 DSKT	3"-5/16"	100	1	295,05
1991-3-3/8 DSKT	3"-3/8"	100	1	295,05
1991-3-7/16 DSKT	3"-7/16"	105	1	295,05
1991-3-1/2 DSKT	3"-1/2"	105	1	295,05
1991-3-9/16 DSKT	3"-9/16"	105	1	346,50
1991-3-5/8 DSKT	3"-5/8"	105	1	346,50
1991-3-11/16 DSKT	3"-11/16"	105	1	346,50
1991-3-13/16 DSKT	3"-13/16"	112	1	378,00
1991-3-7/8 DSKT	3"-7/8"	112	1	378,00
1991-4 DSKT	4"	112	1	418,54



1"



TORX®

TORX®

attacco: 1"

impronta: TORX®

FEEMEC articolo		L mm		Euro
1991-18 GTX	E 18	65	1	36,75
1991-20 GTX	E 20	65	1	36,75
1991-22 GTX	E 22	65	1	36,75
1991-24 GTX	E 24	65	1	36,75
1991-26 GTX	E 26	65	1	36,75
1991-28 GTX	E 28	65	1	36,75
1991-30 GTX	E 30	65	1	36,75
1991-32 GTX	E 32	65	1	36,75

TORX®

	S mm	S mm	
E 4	3.70	E 16	14.60
E 5	4.60	E 18	16.50
E 6	5.60	E 20	18.30
E 7	6.10	E 22	20.10
E 8	7.40	E 24	22.00
E 10	9.30	E 26	23.70
E 11	9.90	E 28	25.50
E 12	11.00	E 30	27.30
E 14	12.80	E 32	29.00



1"



QUADRO

QUADRO FEMMINA

attacco: 1"

impronta: QUADRA

FEEMEC articolo		L mm		Euro
1991-20 VKT	20	60	1	57,75
1991-21 VKT	21	60	1	58,80
1991-22 VKT	22	60	1	59,85
1991-24 VKT	24	60	1	63,00
1991-27 VKT	27	60	1	68,25
1991-30 VKT	30	60	1	68,25
1991-32 VKT	32	60	1	73,50
1991-36 VKT	36	60	1	73,50
1991-38 VKT	38	60	1	78,75
1991-41 VKT	41	60	1	80,85
1991-43 VKT	43	70	1	87,15
1991-46 VKT	46	70	1	87,15
1991-51 VKT	51	70	1	89,25

POLLICI

1991-1-3/4" VKT	1-3/4"	70	1	87,15
1991-1-7/8" VKT	1-7/8"	70	1	88,20

NEW

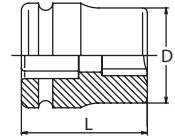

QUADRO

BUSSOLE
QUADRO
FEMMINA

Koken articolo		D mm	L mm		Euro
PS 8-17	17	40	60	1	53,41
PS 8-19	19	43	60	1	53,41
PS 8-20	20	45	62	1	53,41
PS 8-21	21	45	64	1	53,41

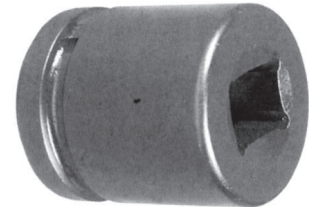

1"



RETTANGOLO

RETTANGOLARI - SETTORE FERROVIARIO

attacco: 1"

impronta: RETTANGOLO

FEEMEC articolo		L mm		Euro
1991-21-28 RVKT-70	21 x 28	70	1	78,75
1991-19-21 RVKT	19 x 21	110	1	78,75
1991-21-28 RVKT	21 x 28	110	1	84,00



ESAGONO

CHIAVI A BUSSOLA
A MACCHINA
BOCCA ESAGONALE
TIPO LUNGO

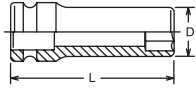

Koken articolo	mm	D mm	L mm		€uro
18300M-17	17	32.8	108	1	62,87
18300M-19	19	35.3	108	1	62,87
18300M-21	21	37.8	108	1	62,87
18300M-22	22	39	108	1	62,87
18300M-23	23	40.3	108	1	62,87
18300M-24	24	41.5	108	1	62,87
18300M-25	25	42.8	108	1	62,87
18300M-26	26	44	108	1	62,87
18300M-27	27	45.3	108	1	62,87
18300M-28	28	46.5	108	1	62,87
18300M-29	29	47.8	108	1	62,87
18300M-30	30	49	108	1	62,87
18300M-31	31	50.3	108	1	62,87
18300M-32	32	51.5	108	1	62,87
18300M-33	33	52.8	108	1	62,87
18300M-34	34	54	108	1	62,87
18300M-35	35	55.3	108	1	63,28
18300M-36	36	56.5	108	1	63,28
18300M-37	37	57.8	108	1	66,58
18300M-38	38	59	108	1	76,81
18300M-40	40	61.5	108	1	76,81
18300M-41	41	62.8	108	1	76,81
18300M-42	42	64	108	1	79,01
18300M-44	44	66.5	108	1	82,69
18300M-45	45	67.8	108	1	82,69
18300M-46	46	69	108	1	88,61
18300M-48	48	71.5	108	1	91,88
18300M-50	50	74	108	1	100,62
18300M-52	52	76.5	108	1	112,45
18300M-55	55	80.3	108	1	112,45
18300M-60	60	86.5	108	1	121,28
18300M-65	65	92.8	108	1	140,97
18300M-70	70	99	108	1	158,95
18300M-75	75	105.3	108	1	175,42
18300M-80	80	117.8	108	1	179,33
18300M-85	85	117.8	108	1	254,51
18300M-90	90	124	108	1	336,44
18300M-95	95	130.3	108	1	440,06

PARETI SOTTILI

SEMI-LUNGA



ESAGONO

CHIAVI A BUSSOLA
A MACCHINA
BOCCA ESAGONALE
SEMI LUNGA

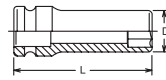

Koken articolo	mm	D mm	L mm		€uro
18301X-17	17	29.8	80	1	63,75
18301X-19	19	32.3	80	1	63,75
18301X-21	21	34.8	80	1	63,75
18301X-22	22	36	80	1	63,75
18301X-24	24	38.5	80	1	63,75
18301X-27	27	42.3	80	1	63,75
18301X-30	30	46	80	1	63,75
18301X-32	32	48.5	85	1	63,75
18301X-33	33	49.8	85	1	63,75
18301X-35	35	52.3	85	1	63,75
18301X-36	36	53.5	85	1	63,75
18301X-38	38	56	85	1	76,15
18301X-41	41	59.8	85	1	81,68
18301X-46	46	66	85	1	85,39
18301X-50	50	71	85	1	103,46



SURFACE DRIVE

CHIAVI A BUSSOLA
A MACCHINA
BOCCA SURFACE
DRIVE
TIPO LUNGO

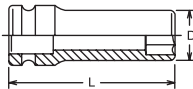

Koken articolo	mm	D mm	L mm		€uro
18310M-24	24	41,5	108	1	68,78
18310M-27	27	45,3	108	1	68,78
18310M-30	30	49	108	1	68,78
18310M-32	32	51,5	108	1	68,78
18310M-33	33	52,8	108	1	68,78
18310M-36	36	56,5	108	1	69,69
18310M-41	41	62,8	108	1	84,59



1"

ESAGONO

LUNGHE

attacco: 1"
impronta: ESAGONO

FERMEC articolo	mm	L mm		€uro
1991-19 L	19	100	1	43,39
1991-21 L	21	100	1	43,39
1991-22 L	22	100	1	43,39
1991-23 L	23	100	1	43,39
1991-24 L	24	100	1	43,39
1991-27 L	27	100	1	43,39
1991-28 L	28	100	1	43,39
1991-30 L	30	100	1	43,39
1991-32 L	32	100	1	43,39
1991-33 L	33	100	1	43,39
1991-34 L	34	100	1	43,89
1991-35 L	35	100	1	44,63
1991-36 L	36	100	1	44,63
1991-38 L	38	100	1	47,25
1991-39 L	39	100	1	49,35
1991-40 L	40	100	1	49,35
1991-41 L	41	100	1	50,40
1991-42 L	42	100	1	50,40
1991-43 L	43	100	1	55,90
1991-44 L	44	100	1	55,90
1991-45 L	44	100	1	58,60
1991-46 L	46	100	1	59,90
1991-48 L	48	100	1	68,25
1991-49 L	49	100	1	71,40
1991-50 L	50	100	1	71,40
1991-51 L	51	105	1	72,45
1991-52 L	52	105	1	73,50
1991-54 L	54	105	1	73,50
1991-55 L	55	105	1	78,75
1991-57 L	57	105	1	81,90
1991-60 L	60	105	1	82,95
1991-65 L	65	118	1	99,75
1991-67 L	67	120	1	126,00
1991-70 L	70	124	1	131,25
1991-75 L	75	124	1	145,95
1991-80 L	80	132	1	157,50
1991-85 L	85	132	1	165,90
1991-90 L	90	140	1	217,04
1991-95 L	95	140	1	285,50
1991-100 L	100	143	1	313,95
1991-105 L	105	143	1	347,55
1991-110 L	110	149	1	366,45
1991-115 L	115	149	1	410,55

IMPACT 1"



LUNGHE ECONOMICHE

attacco: 1"

impronta: ESAGONO

BGS articolo	mm	L mm		Euro
BGS 5500-17	17	90	1	29,33
BGS 5500-19	19	90	1	29,33
BGS 5500-21	21	90	1	29,33
BGS 5500-22	NEW 22	90	1	29,33
BGS 5500-24	24	90	1	29,33
BGS 5500-27	27	90	1	29,33
BGS 5500-30	30	90	1	29,33
BGS 5500-32	32	90	1	29,33
BGS 5500-33	33	90	1	29,33
BGS 5500-34	NEW 34	90	1	30,60
BGS 5500-36	36	90	1	30,60
BGS 5500-38	38	90	1	34,94
BGS 5500-41	41	95	1	39,53
BGS 5500-46	46	95	1	47,18
BGS 5500-50	50	100	1	49,73
BGS 5500-55	55	105	1	63,75
BGS 5500-60	60	110	1	82,88
BGS 5500-65	65	115	1	102,00
BGS 5500-70	NEW 70	115	1	127,50
BGS 5500-75	NEW 75	115	1	155,00
BGS 5500-80	80	135	1	173,75
BGS 5500-85	85	140	1	262,50
BGS 5500-90	90	140	1	300,00
BGS 5500-95	95	140	1	320,00
BGS 5500-100	100	155	1	345,00
BGS 5500-105	105	155	1	365,00
BGS 5500-110	110	155	1	387,50
BGS 5500-115	115	155	1	410,00



BGS articolo	DESCRIZIONE	Euro
BGS 5500	SET 8 PEZZI BUSSOLE A MACCHINA LUNGHE	248,75

CARATTERISTICHE

- finitura fosfatata
- comprende le seguenti bussole esagonali:
 - 27 mm, lungh. 90 mm - 30 mm, lungh. 90 mm
 - 32 mm, lungh. 90 mm - 36 mm, lungh. 90 mm
 - 38 mm, lungh. 95 mm - 41 mm, lungh. 95 mm
 - 46 mm, lungh. 95 mm - 50 mm, lungh. 100 mm
- con scanalatura e foro per spina
- in cassetta metallica

POLLICI



CHIAVI A BUSSOLA
A MACCHINA
BOCCA ESAGONALE
TIPO LUNGO

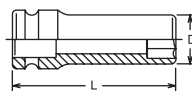

Koken articolo	pollici	D mm	L mm		€uro
18300A-11/16	11/16"	32.8	108	1	67,68
18300A-3/4	3/4"	35.3	108	1	67,68
18300A-7/8	7/8"	39	108	1	67,68
18300A-15/16	15/16"	41.5	108	1	67,68
18300A-1	1"	42.8	108	1	67,68
18300A-1-1/16	1-1/16"	45.3	108	1	67,68
18300A-1-1/8	1-1/8"	47.8	108	1	67,68
18300A-1-3/16	1-3/16"	49	108	1	67,68
18300A-1-1/4	1-1/4"	51.5	108	1	67,68
18300A-1-5/16	1-5/16"	54	108	1	67,68
18300A-1-3/8	1-3/8"	55.3	108	1	68,17
18300A-1-7/16	1-7/16"	57.8	108	1	71,75
18300A-1-1/2	1-1/2"	59	108	1	82,80
18300A-1-9/16	1-9/16"	61.5	108	1	82,80
18300A-1-5/8	1-5/8"	62.8	108	1	82,80
18300A-1-11/16	1-11/16"	65.3	108	1	89,10
18300A-1-3/4	1-3/4"	67.8	108	1	89,10
18300A-1-13/16	1-13/16"	69	108	1	95,45
18300A-1-7/8	1-7/8"	71.5	108	1	98,97
18300A-1-15/16	1-15/16"	72.8	108	1	98,97
18300A-2	2"	75.3	108	1	119,43
18300A-2-1/16	2-1/16"	76.5	108	1	121,19
18300A-2-1/8	2-1/8"	79	108	1	121,19
18300A-2-3/16	2-3/16"	80.3	108	1	127,00
18300A-2-1/4	2-1/4"	82.8	108	1	130,68
18300A-2-5/16	2-5/16"	84	108	1	130,68
18300A-2-3/8	2-3/8"	86.5	108	1	130,68
18300A-2-7/16	2-7/16"	89	108	1	146,25
18300A-2-1/2	2-1/2"	91.5	108	1	146,25
18300A-2-9/16	2-9/16"	92.8	108	1	151,91
18300A-2-5/8	2-5/8"	95.3	108	1	151,91
18300A-2-3/4	2-3/4"	99	108	1	171,27
18300A-2-7/8	2-7/8"	102.8	108	1	176,80
18300A-2-15/16	2-15/16"	105.3	108	1	194,45
18300A-3	3"	106.5	108	1	194,45
18300A-3-1/16	3-1/16"	109	108	1	194,45
18300A-3-1/8	3-1/8"	111.5	108	1	198,85
18300A-3-3/16	3-3/16"	112.8	108	1	198,85

PARETI SOTTILI



CHIAVI A BUSSOLA
A MACCHINA BOCCA
ESAGONALE PARETI
SOTTILI TIPO LUNGO

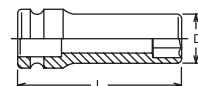

Koken articolo	mm	D mm	L mm		Euro
18301M-17	17	29.8	108	1	62,87
18301M-18	18	31	108	1	62,87
18301M-19	19	32.3	108	1	62,87
18301M-20	20	33.5	108	1	65,53
18301M-21	21	34.8	108	1	62,87
18301M-22	22	36	108	1	62,87
18301M-23	23	37.3	108	1	62,87
18301M-24	24	38.5	108	1	62,87
18301M-26	26	41	108	1	62,87
18301M-27	27	42.3	108	1	62,87
18301M-29	29	44.8	108	1	62,87
18301M-30	30	46	108	1	62,87
18301M-32	32	48.5	108	1	62,87
18301M-33	33	49.8	108	1	62,87
18301M-34	34	51	108	1	63,28
18301M-35	35	52.3	108	1	63,28
18301M-36	36	53.5	108	1	63,28
18301M-38	38	56	108	1	76,81
18301M-39	39	57.3	108	1	76,81
18301M-41	41	59.8	108	1	76,81
NEW 18301M-42	42	61	108	1	79,01
18301M-43	43	62.3	108	1	82,69
18301M-46	46	66	108	1	88,61
18301M-50	50	71	108	1	100,62
NEW 18301M-55	55	77.3	108	1	112,45
NEW 18301M-60	60	83.5	108	1	121,28
NEW 18301M-65	65	89.8	108	1	140,97
NEW 18301M-70	70	96	108	1	158,95



ESAGONO QUADRO

CHIAVI A BUSSOLA
A MACCHINA PER
AUTOTRENO

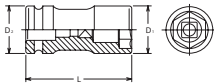

Koken articolo	mm	mm	L mm		Euro
18316M-35x17	35	17	108	1	76,04
18316M-38x20	38	20	108	1	84,87
18316M-41x19	41	19	108	1	92,02
18316M-41x21	41	21	108	1	92,02



1" OTTAGONALE

CHIAVI A BUSSOLA
BOCCA
OTTAGONALE
OTTO LATI
TIPO LUNGO



FEARMEC articolo	mm	L mm		Euro
1991-70 OKT	70	140	1	99,75
1991-80 OKT	80	140	1	110,25
1991-83 OKT	83	140	1	115,50
1991-86 OKT	86	140	1	126,00
1991-90 OKT	90	140	1	136,50
1991-95 OKT	95	140	1	157,50
1991-96 OKT	96	140	1	157,50
1991-100 OKT	100	140	1	162,75
1991-102 OKT	102	140	1	162,75
1991-105 OKT	105	140	1	168,00
1991-108 OKT	108	140	1	189,00
1991-110 OKT	110	140	1	189,00
1991-115 OKT	115	140	1	199,50
1991-118 OKT	118	140	1	220,50
1991-120 OKT	120	140	1	220,50
1991-125 OKT	125	140	1	220,50
1991-130 OKT	130	140	1	220,50
1991-135 OKT	135	140	1	262,50
1991-140 OKT	140	140	1	294,00

BARRE DI
TORSIONE



ESAGONO

BARRE DI
TORSIONE
BOCCA
ESAGONALE

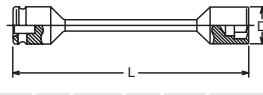

Koken articolo	mm	Nm	D mm	L mm		Euro
18101M-24 X 350 NM	24	350	43.5	300	1	114,65
18101M-27 X 350 NM	27	350	47	300	1	114,65
18101M-27 X 450 NM	27	450	47	300	1	114,65
18101M-29 X 400 NM	29	400	47.8	300	1	114,65
18101M-30 X 500NM	30	500	51	300	1	118,83
18101M-32 X 450 NM	32	450	53.5	300	1	124,05
18101M-32 X 550 NM	32	550	53.5	300	1	124,05
18101M-32 X 600 NM	32	600	53.5	300	1	124,05
18101M-32 X 700 NM	32	700	53.5	300	1	124,05
18101M-33 X 550 NM	33	550	55	300	1	124,05
18101M-33 X 600 NM	33	600	55	300	1	124,05
18101M-33 X 650 NM (OZAT)	33	650	58.5	300	1	196,35
18101M-36 X 600 NM	36	600	58.5	300	1	139,40

Non utilizzare la barra di torsione per svitare i dadi, ma solo per avvitare.

Per sicurezza, controllare sempre il serraggio con chiave dinamometrica.



ESAGONO

CHIAVI A
BUSSOLA EXTRA
LUNGHE

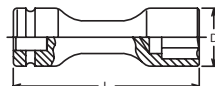

Koken articolo	mm	D mm	L mm		Euro
18104M-24	24	41.5	170	1	101,59
18104M-27	27	45.3	170	1	101,59
18104M-28	28	46.5	170	1	101,59
18104M-30	30	49	170	1	102,99
18104M-32	32	51.5	170	1	108,79
18104M-33	33	52.8	170	1	108,79
18104M-34	34	54	170	1	113,69
18104M-36	36	56.5	170	1	113,69



ESAGONO

CHIAVI A BUSSOLA
EXTRA LUNGHE
VUOTE

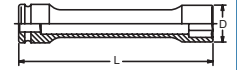

Koken articolo	mm	D mm	L mm		Euro
18102M-270-23	23	37.3	270	1	144,68
18102M-270-24	24	38.5	270	1	144,68
18102M-270-26	26	41	270	1	144,68
18102M-270-27	27	42.3	270	1	144,68
18102M-270-29	29	44.8	270	1	144,68
18102M-270-30	30	46	270	1	144,68
18102M-270-32	32	48.5	270	1	153,62
18102M-270-33	33	49.8	270	1	153,62
18102M-270-34	34	51	270	1	153,62
18102M-270-36	36	53.5	270	1	153,62
18102M-270-38	38	56	270	1	164,59
18102M-270-41	41	60	270	1	239,77
1991-41L-270	41		270	1	336,00
1991-46L-270	46		270	1	488,25
1991-50L-270	50		270	1	556,50
1991-55L-270	55		270	1	588,00
18102M-400-23	23	37.3	400	1	165,99
18102M-400-24	24	38.5	400	1	165,99
18102M-400-26	26	41	400	1	165,99
18102M-400-27	27	42.3	400	1	165,99
18102M-400-29	29	44.8	400	1	165,99
18102M-400-30	30	46	400	1	165,99
18102M-400-32	32	48.5	400	1	167,04
18102M-400-33	33	49.8	400	1	168,52
18102M-400-34	34	51	400	1	168,52
18102M-400-36	36	53.5	400	1	168,52
18102M-400-38	38	56	400	1	176,36



IMPACT 1"



ESAGONO

PER USO A MANO

CHIAVI A BUSSOLA
MASCHIO
ESAGONALE
INTEGRALE

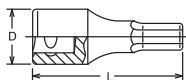

Koken articolo	mm	D mm	L mm		Euro
8012M-80-17	17	44.2	80	1	55,28
8012M-80-19	19	44.2	80	1	55,28
8012M-80-22	22	47.9	80	1	55,28
8012M-80-24	24	47.9	80	1	55,28
8012M-80-27	27	47.9	80	1	55,28
8012M-80-30	30	47.9	80	1	55,28
8012M-80-32	32	47.9	80	1	58,55
8012M-80-36	36	54.2	80	1	61,71

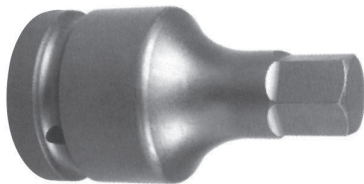

1"

ESAGONO

BUSSOLE ESAGONALI IMPACT MASCHIO
BRUNITE CON FORO NEL QUADRO PER
SPINA E ANELLO

attacco: 1"

impronta: ESAGONO BRUGOLA

FERMEC articolo	mm	L mm		Euro
181 - 1" - 14	14	71	1	47,25
181 - 1" - 17	17	71	1	47,25
181 - 1" - 19	19	71	1	47,25
181 - 1" - 22	22	75	1	49,35
181 - 1" - 24	24	75	1	49,35
181 - 1" - 27	27	82	1	49,35
181 - 1" - 30	30	82	1	49,35
181 - 1" - 32	32	82	1	49,35
182 - 1" - 17	17	100	1	75,08
182 - 1" - 19	19	100	1	75,08
182 - 1" - 22	22	100	1	75,08
182 - 1" - 24	24	100	1	75,08
182 - 1" - 27	27	100	1	75,08
182 - 1" - 30	30	100	1	75,08
182 - 1" - 32	32	100	1	75,08
182 - 1" - 36	36	100	1	75,08
182 - 1" - 38	38	100	1	75,08
182 - 1" - 41	41	100	1	75,08
182 - 1" - 46	46	100	1	75,08

NEW 4182 - 1" - 14	14	150	1	85,00
NEW 4182 - 1" - 17	17	150	1	85,00
NEW 4182 - 1" - 19	19	150	1	85,00
NEW 4182 - 1" - 22	22	150	1	85,00
NEW 4182 - 1" - 24	24	150	1	85,00
NEW 4182 - 1" - 27	27	150	1	85,00
NEW 4182 - 1" - 30	30	150	1	85,00
NEW 4182 - 1" - 32	32	150	1	85,00



NEW

ESAGONO

FERMEC articolo	DESCRIZIONE	Euro
541051	SET 5 PEZZI, BUSSOLE IMPACT ATT. 1", ESAGONALE MASCHIO	320,00

CARATTERISTICHE

- lunghezza 100 mm
- atta quadro femmina 1"
- misure: 17-19-22-24-27 mm
- in cassetta metallica

POLLICI



1"

ESAGONO

BUSSOLE ESAGONALI IMPACT MASCHIO
BRUNITE CON FORO NEL QUADRO PER
SPINA E ANELLO - MISURE IN POLLICI

attacco: 1"

impronta: ESAGONO BRUGOLA

FERMEC articolo	pollici	L mm		Euro
182 W-1"-1/2	1/2"	71	1	65,48
182 W-1"-9/16	9/16"	71	1	65,48
182 W-1"-5/8	5/8"	71	1	65,48
182 W-1"-3/4	3/4"	71	1	65,48
182 W-1"-13/16	13/16"	75	1	65,48
182 W-1"-7/8	7/8"	75	1	65,48
182 W-1"-1	1"	75	1	65,48
182 W-1"-1-1/16	1-1/16"	82	1	65,48
182 W-1"-1-1/8	1-1/8"	82	1	65,48
182 W-1"-1-3/16	1-3/16"	82	1	65,48
182 W-1"-1-1/4	1-1/4"	82	1	65,48
182 W-1"-1-5/16	1-5/16"	100	1	78,75
182 W-1"-1-3/8	1-3/8"	100	1	78,75
182 W-1"-1-1/2	1-1/2"	100	1	78,75
182 W-1"-1-5/8	1-5/8"	100	1	78,75
182 W-1"-1-3/4	1-3/4"	100	1	78,75
182 W-1"-1-13/16	1-13/16"	100	1	78,75

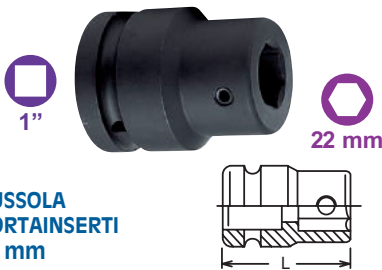

BUSSOLA PORTAINSERTI 22 mm

Koken articolo	D mm	L mm	Box	Euro
18107	54	70	1	47,63



INSERTO CON MASCHIO ESAGONALE PER USO CON BUSSOLA 18107

articolo	mm	L mm	Box	Euro
7 RB 014	14	107/140	1	20,48
7 RB 017	17	107/140	1	20,48
7 RB 019	19	107/140	1	20,48
7 RB 022	22	107/140	1	20,48
7 RB 024	24	107/140	1	20,48



INSERTO CON MASCHIO TORX® PER USO CON BUSSOLA 18107

articolo		L mm	Box	Euro
7 LB 060	TX 60	107/140	1	26,25
7 LB 070	TX 70	107/140	1	26,25
7 LB 080	TX 80	107/140	1	26,25
7 LB 090	TX 90	107/140	1	26,25
7 LB 100	TX 100	107/140	1	26,25

TORX®	S mm	S mm	
T 6	1.70	T 40	6.70
T 7	2.00	T 45	7.90
T 8	2.30	T 50	8.90
T 9	2.50	T 55	11.30
T 10	2.70	T 60	13.30
T 15	3.30	T 70	15.60
T 20	3.90	T 80	17.60
T 25	4.50	T 90	20.00
T 27	5.00	T 100	22.20
T 30	5.60		



BGS articolo	DESCRIZIONE	Euro
BGS 5246	SET 16 PEZZI INSERTI XXL	224,88

- CARATTERISTICHE**
- 13 inserti, attacco esagonale 22 mm:
 - Torx: Tx60, Tx70, Tx 80, Tx 90, Tx 100
 - Esagono: 17, 19, 22, 24 mm
 - Torx femmina: E18, E20, E22, E24
 - 2 bussole porta inserti da 22 mm, attacco quadro femmina da 3/4" e 1"
 - chiavi esagonali a L per fissaggio inserti sulle bussole
 - per uso con avvitatori pneumatici
 - inserti attacco esagonale 22 mm
 - lunghezza inserti 100 mm

BGS	DESCRIZIONE	Euro
BGS 5246-T60	INSERTO TX 60	17,34
BGS 5246-T70	INSERTO TX 70	17,85
BGS 5246-T80	INSERTO TX 80	19,13
BGS 5246-T90	INSERTO TX 90	20,40
BGS 5246-T100	INSERTO TX 100	21,68
BGS 5246-E18	INSERTO E-18	17,34
BGS 5246-E20	INSERTO E-20	17,34
BGS 5246-E22	INSERTO E-22	18,36
BGS 5246-E24	INSERTO E-24	18,36
BGS 5246-H17	INSERTO ESAC. 17 MM	17,34
BGS 5246-H19	INSERTO ESAC. 19 MM	17,60
BGS 5246-H22	INSERTO ESAC. 22 MM	18,36
BGS 5246-H24	INSERTO ESAC. 24 MM	19,13
BGS 5246-2	BUSSOLA ATT. 3/4", PORTAINSERTI 22 MM	15,81
BGS 5246-1	BUSSOLA ATT. 1", PORTAINSERTI 22 MM	24,23



BUSSOLA PORTAINSERTI 22 mm

Koken articolo	D mm	L mm	Box	Euro
16107	44	60	1	32,69

Koken articolo	DESCRIZIONE	Euro
16107-SC	GRANO DI RICAMBIO M8X14, ESAGONO 4 MM	0,74

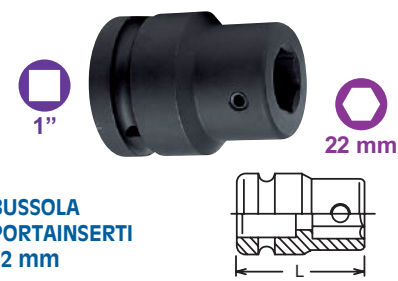

BUSSOLA PORTAINSERTI 22 mm

Koken articolo	D mm	L mm	Box	Euro
18107	54	70	1	47,63

INSERTO CON MASCHIO ESAGONALE

Koken articolo	mm	L mm	Box	Euro
107-22-17	17	50	1	11,03
107-22-19	19	50	1	11,03
107-22-22	22	50	1	11,03
107-22-24	24	50	1	12,43
107-22-27	27	50	1	14,33
107-22-30	30	50	1	16,91
107-22-32	32	55	1	18,43
107-22-5/8	5/8"	50	1	11,85
107-22-3/4	3/4"	50	1	11,85
107-22-7/8	7/8"	50	1	11,85
107-22-1	1"	50	1	13,42
107-22-1-1/4	1-1/4"	55	1	19,83

IMPACT 1"

22 mm TORX®

INSERTO CON MASCHIO TORX®

Koken articolo	INS.	L mm	ESAG.	Euro
107-22-T 70	TX 70	60	1	26,21
107-22-T 80	TX 80	60	1	27,56
107-22-T 90	TX 90	60	1	27,75
107-22-T100	TX 100	60	1	27,94

ESAGONO TORX®

FEFMEC articolo	DESCRIZIONE	Euro
TS 110	TRUCKS SOCKETS SET IN CASSETTA METALLICA	239,19

- CARATTERISTICHE**
- specifico per veicoli industriali e movimento terra
 - set 11 pezzi
 - chiavi esagonali a L per fissaggio inserti sulle bussole
 - inserti attacco esagonale 16 e 22 mm

RICAMBI

FEFMEC articolo	DESCRIZIONE	Euro
107-16-12	INS. ESAG. 12 MM, ATT. 16 MM	8,31
107-16-14	INS. ESAG. 14 MM, ATT. 16 MM	8,31
107-16-17	INS. ESAG. 17 MM, ATT. 16 MM	9,13
107-16-19	INS. ESAG. 19 MM, ATT. 16 MM	9,68
107-16-22	INS. ESAG. 22 MM, ATT. 16 MM	11,03
107-16-T55	INS. TORX TX55, ATT. 16 MM	13,86
107-16-T60	INS. TORX TX60, ATT. 16 MM	13,86
107-16-T70	INS. TORX TX70, ATT. 16 MM	13,86
107-22-T80	INS. TORX TX80, ATT. 22 MM	27,56
107-22-T90	INS. TORX TX90, ATT. 22 MM	27,75
107-22-T100	INS. TORX TX100, ATT. 22 MM	27,94
16106	BUSSOLA PORTA PUNTE QUADRO 3/4", ESAG. 16 MM	30,00
18107	BUSSOLA PORTA PUNTE QUADRO 1", ESAG. 22 MM	47,63

1" **PROLUNGHE PER BUSSOLE "POWER IMPACT" MASCHIO/MASCHIO**

FEFMEC articolo	L mm	ESAG.	Euro
Z1603	76	1	36,75
Z1604	101	1	36,75
Z1605	127	1	51,45
Z1606	152	1	51,45
Z1616	406	1	189,00

B A **RIDUZIONI PER BUSSOLE "POWER IMPACT" FEMMINA/FEMMINA**

FEFMEC articolo	B	A	L mm	ESAG.	Euro
AN 1612	1"	3/4"	63	1	103,95
AN 1616	1"	1"	59	1	94,50
AN 2416	1-1/2"	1"	83	1	252,00

FORO **PROLUNGA**

Koken articolo	D mm	FORO	L mm	ESAG.	Euro
18760-175	54	FORO	50	1	71,47
18760-200	54	FORO	75	1	83,71
18760-250	54	FORO	100	1	83,71
18760-330	54	FORO	125	1	96,42

FORO **PROLUNGHE PER BUSSOLE "POWER IMPACT" MASCHIO/FEMMINA**

FEFMEC articolo	FORO	L mm	ESAG.	Euro
97-16-100	FORO	100	1	63,00
97-16-125	FORO	125	1	63,00
97-16-175	FORO	175	1	63,00
97-17	FORO	250	1	73,50
97-18	FORO	330	1	81,90
97-18-400	FORO	400	1	100,80

1" **3/4"** **RACCORDO DI RIDUZIONE QUADRO MASCHIO 3/4" E FEMMINA 1"**

Koken articolo	L mm	ESAG.	Euro
18866A-65	65	1	48,13
18866A-200	200	1	75,65

1" **1-1/2"** **RACCORDO DI RIDUZIONE QUADRO MASCHIO 1-1/2" E FEMMINA 1"**

Koken articolo	L mm	ESAG.	Euro
18877A	80	1	93,69

SNODO UNIVERSALE

Koken articolo	L mm	ESAG.	Euro
18770	127	1	134,75

SNODO UNIVERSALE

Koken articolo	L mm	ESAG.	Euro
18771	115	1	134,75

NEW

1/4" 3/8" 1/2" PRO+ CROMO

BGS articolo	DESCRIZIONE	Euro
BGS 9459	SET 3 PEZZI, SNODI	38,00

CARATTERISTICHE

- con scanalatura e foro per spina
- comprende:
 - snodo 1/4" F - 1/4" M
 - snodo 3/8" F - 3/8" M
 - snodo 1/2" F - 1/2" M

MANDRINO CON SGANCIO RAPIDO PER BUSSOLE "POWER IMPACT"

attacco: Quadro femmina
impronta: DIN 3126, E 11,2 - E 6,35

articolo	F	M	L mm	Euro
195-SWF	1/4"	1/4"	41	42,00
196-SWF	3/8"	3/8"	46	42,00
197-SWF	1/2"	1/2"	60	46,20
199-SWF	3/4"	3/4"	78	114,35
1991-SWF	1"	1"	100	131,25
Koken				
12222 AL	1/4"	1/4"	35	50,44
13333 AL	3/8"	3/8"	45	53,05
14444 AL	1/2"	1/2"	55	58,27
16666 AL	3/4"	3/4"	75	121,94
18888 AL	1"	1"	95	178,01

ARTICOLO NON SOGGETTO A GARANZIA

RACCORDI DI RIDUZIONE "POWER IMPACT" MASCHIO/FEMMINA

articolo	F	M	L mm	Euro
96-00	PERNO 1/4"	3/8"	32	12,47
96-0	PERNO 3/8"	1/4"	35	12,47
96-1	PERNO 3/8"	1/2"	45	12,47
96-01	PERNO 1/2"	1/4"	38	13,00
96-2	PERNO 1/2"	3/8"	45	13,56
96-3	FORO 5/8"	1/2"	50	20,07
96-4	PERNO 3/4"	1/2"	70	23,32
96-5	FORO 3/4"	5/8"	70	26,58
96-6	FORO 5/8"	3/4"	70	20,61
96-7	FORO 1/2"	5/8"	50	16,26
96-8	FORO 3/4"	1"	70	28,74
96-9	FORO 1"	3/4"	70	35,79
96-10	PERNO 1"	1/2"	70	65,00
96-11	FORO 1/2"	3/4"	50	17,89
96-12	FORO 1 1/2"	1"	115	121,80
96-13	FORO 1"	1 1/2"	115	51,51
96-14	FORO 2 1/2"	1 1/2"	115	379,60
96-15	FORO 1 1/2"	2 1/2"	120	260,30
96-16	FORO 1 1/4"	1"	140	126,00
96-17	FORO 1 3/4"	1 1/2"	150	294,00

RACCORDI DI RIDUZIONE MAGNETICI "POWER IMPACT" A SCOMPARSA - SPAZI RIDOTTI

articolo	F	M	L mm	Euro
698-00	1/4"	3/8"	17	10,00
698-0	1/4"	1/2"	22	10,00
698-1	3/8"	1/2"	22	10,50
698-11	1/2"	3/4"	30	14,70
698-8	3/4"	1"	35	21,00
698-13	1"	1 1/2"	50	31,50
698-15	1 1/2"	2 1/2"	60	210,00
698	CASSETTA 4 PZ. CONTENUTO: 1 PZ. 698-00 1 PZ. 698-1 1 PZ. 698-11 1 PZ. 698-8			63,00

RACCORDI DI RIDUZIONE "POWER IMPACT" MASCHIO/FEMMINA CON SFERA DI TENUTA NEL QUADRO MASCHIO

articolo	F	M	L mm	Euro
696-00 S	1/4"	3/8"	26	10,00
696-0 S	3/8"	1/4"	32	10,00
696-01 S	1/2"	1/4"	36	10,00
696-1 S	3/8"	1/2"	36	10,00
696-2 S	1/2"	3/8"	38	10,50
696-11 S	1/2"	3/4"	48	12,60
696-4 S	3/4"	1/2"	56	16,80
696-8 S	3/4"	1"	63	22,05
696-9 S	1"	3/4"	75	28,35

PRO+ CROMO

BGS articolo	DESCRIZIONE	Euro
BGS 200	SET 6 PEZZI RIDUZIONI A MACCHINA	46,92

CARATTERISTICHE

- rivestimento specifico nero opaco

CONTENUTO

- 1/4" F X 3/8" M, coppia massima 60 Nm
- 3/8" F X 1/4" M, coppia massima 60 Nm
- 3/8" F X 1/2" M, coppia massima 200 Nm
- 1/2" F X 3/8" M, coppia massima 200 Nm
- 1/2" F X 3/4" M, coppia massima 500 Nm
- 3/4" F X 1/2" M, coppia massima 500 Nm

RICAMBI

BGS articolo	DESCRIZIONE	Euro
BGS 200-LEER	CASSETTA VUOTA	5,46

PRO+ **CRO MO**

BGS articolo	DESCRIZIONE	Euro
BGS 25140	SET 11 PEZZI RIDUZIONI E SNODI A MACCHINA	113,48

CARATTERISTICHE

- rivestimento specifico nero opaco

CONTENUTO

- 1/4" F x 3/8" M
- 3/8" F x 1/4" M
- 3/8" F x 1/2" M
- 1/2" F x 3/8" M
- 1/2" F x 3/4" M
- 3/4" F x 1/2" M
- 3/4" F x 1" M
- 1" F x 3/4" M
- snodi da 1/4", 3/8", 1/2"

RACCORDI DI RIDUZIONE A MANDRINO CON SGANCIO RAPIDO "POWER IMPACT"

FERMEC articolo	F	M	L mm	Euro
691-0 SWF	3/8"	1/4"	55	31,50
691-1 SWF	3/8"	1/2"	60	31,50
691-2 SWF	1/2"	3/8"	55	36,75
691-11 SWF	1/2"	3/4"	75	42,00
691-4 SWF	3/4"	1/2"	70	42,00
691-9 SWF	1"	3/4"	90	73,50

SPINE ACCIAIO PER BUSSOLE

Koken articolo	Ø	L mm	Euro
1200 A	1/4"	10,2	0,44
1301 A	3/8"	14,5	0,44
1302 A	3/8"	17,5	0,44
1401 A	1/2"	20	0,74
1402 A	1/2"	25	0,74
1500 A	5/8"	30	0,74
1601 A	3/4"	35	0,83
1602 A	3/4"	45	0,94
1801 A	1"	45	0,94
1802 A	1"	75	1,82
1701 A	1 1/2"	75	1,98
1702 A	1 1/2"	110	3,99
1901 A	2 1/2"	110	4,46
1902 A	2 1/2"	155	5,06
2001 A	3 1/2"	155	8,36
2002 A	3 1/2"	180	6,90

MOLLA DI SICUREZZA PER BUSSOLE

Koken articolo	Ø	Euro
1301C	3/8" ≤12	0,94
1302C	3/8" >12	0,94
1401C	1/2" ≤14	1,18
1402C	1/2" >14	1,18
1600C	3/4" ≤46	2,26
1801C	1" ≤70	2,23
1802C	1" >70	7,87
1700C	1 1/2" ≤90	8,22

ANELLI DI GOMMA PER BUSSOLE

Koken articolo	Ø	D mm	Euro
1200 B	1/4"	9	0,72
1301 B	3/8"	13	0,83
1302 B	3/8"	16	0,88
1401 B	1/2"	19	1,02
1402 B	1/2"	24	1,10
1500 B	5/8"	28	1,35
1601 B	3/4"	36	1,46
1602 B	3/4"	45	2,15
1801 B	1"	45	1,98
1802 B	1"	75	8,72
1701 B	1 1/2"	75	8,58
1702 B	1 1/2"	114	21,42
1901 B	2 1/2"	114	22,25
1902 B	2 1/2"	158	27,72
2001 B	3 1/2"	158	82,80
2002 B	3 1/2"	183	91,88

ESTRATTORE PER MOLLE DI SICUREZZA

Koken articolo	Ø	Euro
149	3/8" - 1/2"	1,57
152	3/4" - 1"	1,68

SET MOLLE DI SICUREZZA PER BUSSOLE

Koken articolo	nr.	Euro
PK1301 C-10	10	13,92
PK1302 C-10	10	13,92
PK1401 C-10	10	16,86
PK1402 C-10	10	16,86
PK1600 C-10	10	25,82
PK1801 C-10	10	26,32



1-1/2"

ESAGONO

BUSSOLE ESAGONALI

attacco: 1 1/2"

impronta: ESAGONO

FEFMEC articolo	mm	L mm		Euro
1992-30	30	80	1	115,50
1992-32	32	80	1	115,50
1992-35	35	80	1	115,50
1992-36	36	80	1	115,50
1992-38	38	80	1	115,50
1992-40	40	80	1	115,50
1992-41	41	80	1	115,50
1992-42	42	80	1	115,50
1992-43	43	82	1	115,50
1992-44	44	83	1	115,50
1992-46	46	84	1	115,50
1992-48	48	80	1	115,50
1992-50	50	84	1	115,50
1992-51	51	84	1	115,50
1992-52	52	84	1	115,50
1992-54	54	86	1	115,50
1992-55	55	90	1	115,50
1992-60	60	90	1	115,50
1992-65	65	95	1	135,57
1992-67	67	95	1	145,95
1992-70	70	100	1	157,26
1992-73	73	100	1	189,80
1992-75	75	105	1	189,80
1992-80	80	110	1	211,49
1992-85	85	110	1	244,03
1992-86	86	110	1	262,50
1992-90	90	115	1	268,43
1992-95	95	115	1	341,64
1992-100	100	120	1	376,89
1992-105	105	120	1	414,84
1992-110	110	125	1	479,91
1992-115	115	130	1	515,16
1992-120	120	135	1	553,13
1992-125	125	135	1	596,51
1992-130	130	145	1	720,30
1992-135	135	145	1	1034,67
1992-140	140	150	1	1149,63
1992-145	145	155	1	1149,63
1992-150	150	160	1	1379,56
1992-155	155	165	1	1379,56

POLLICI



1-1/2"

ESAGONO

BUSSOLE ESAGONALI MISURE IN POLLICI

attacco: 1 1/2"

impronta: ESAGONO

FEFMEC articolo	pollici	L mm		Euro
1992-1-5/16	1-5/16"	80	1	115,50
1992-1-7/16	1-7/16"	80	1	115,50
1992-1-9/16	1-9/16"	80	1	115,50
1992-1-11/16	1-11/16"	80	1	115,50
1992-1-3/4	1-3/4"	80	1	115,50
1992-1-7/8	1-7/8"	82	1	115,50
1992-2	2"	82	1	115,50
1992-2-1/16	2-1/16"	90	1	115,50
1992-2-3/16	2-3/16"	90	1	126,00
1992-2-1/4	2-1/4"	90	1	126,00
1992-2-5/16	2-5/16"	92	1	126,00
1992-2-3/8	2-3/8"	95	1	126,00
1992-2-7/16	2-7/16"	95	1	126,00
1992-2-1/2	2-1/2"	95	1	126,00
1992-2-5/8	2-5/8"	100	1	126,00
1992-2-11/16	2-11/16"	100	1	182,70
1992-2-13/16	2-13/16"	105	1	231,00
1992-2-7/8	2-7/8"	105	1	252,00
1992-2-15/16	2-15/16"	110	1	278,25
1992-3	3"	110	1	278,25
1992-3-1/8	3-1/8"	115	1	312,90
1992-3-1/4	3-1/4"	115	1	312,90
1992-3-5/16	3-5/16"	115	1	321,98
1992-3-3/8	3-3/8"	115	1	340,20
1992-3-7/16	3-7/16"	118	1	348,83
1992-3-1/2	3-1/2"	118	1	346,50
1992-3-11/16	3-11/16"	118	1	526,12
1992-3-7/8	3-7/8"	125	1	574,22
1992-4	4"	125	1	598,50
1992-4-1/16	4-1/16"	125	1	681,53
1992-4-1/4	4-1/4"	137	1	681,53
1992-4-7/16	4-7/16"	137	1	740,57
1992-4-1/2	4-1/2"	137	1	740,57
1992-4-5/8	4-5/8"	143	1	819,00
1992-5	5"	150	1	869,40



1-1/2"

ESAGONO

LUNGHE

attacco: 1 1/2"

impronta: ESAGONO

FEFMEC articolo	mm	L mm		Euro
1992-36 L	36	140	1	161,70
1992-38 L	38	140	1	161,70
1992-41 L	41	140	1	161,70
1992-42 L	42	140	1	170,10
1992-43 L	43	140	1	170,10
1992-46 L	46	140	1	170,10
1992-48 L	48	140	1	170,10
1992-50 L	50	140	1	186,90
1992-52 L	52	140	1	186,90
1992-54 L	54	140	1	215,25
1992-55 L	55	140	1	215,25
1992-60 L	60	140	1	252,00
1992-65 L	65	140	1	267,75
1992-70 L	70	140	1	340,20
1992-75 L	75	140	1	375,90
1992-80 L	80	140	1	402,15
1992-85 L	85	140	1	458,85
1992-90 L	90	140	1	546,00
1992-95 L	95	150	1	659,40
1992-100 L	100	150	1	794,85
1992-105 L	105	150	1	876,75
1992-110 L	110	160	1	957,60
1992-115 L	115	160	1	984,90
1992-120 L	120	170	1	984,90
1992-125 L	125	170	1	1050,53
1992-130 L	130	185	1	1050,53



1-1/2"



POLIGONALE

BUSSOLE POLIGONALI

attacco: 1 1/2"

impronta: POLIGONALE

FEIMEC articolo	mm	L mm		Euro
1992-36 DSKT	36	80	1	136,50
1992-38 DSKT	38	80	1	136,50
1992-41 DSKT	41	80	1	136,50
1992-46 DSKT	46	80	1	136,50
1992-50 DSKT	50	82	1	141,75
1992-55 DSKT	55	90	1	141,75
1992-60 DSKT	60	90	1	168,00
1992-65 DSKT	65	96	1	186,90
1992-70 DSKT	70	100	1	252,00
1992-75 DSKT	75	105	1	304,50
1992-80 DSKT	80	110	1	357,00
1992-85 DSKT	85	116	1	378,00
1992-90 DSKT	90	118	1	413,70
1992-95 DSKT	95	118	1	630,00
1992-100 DSKT	100	125	1	703,50
1992-105 DSKT	105	125	1	803,25
1992-110 DSKT	110	137	1	871,50
1992-115 DSKT	115	137	1	871,50
1992-120 DSKT	120	145	1	961,80
1992-125 DSKT	125	145	1	976,50
1992-130 DSKT	130	150	1	1023,75

POLLICI



1-1/2"



POLIGONALE

BUSSOLE POLIGONALI MISURE IN POLLICI

attacco: 1 1/2"

impronta: POLIGONALE

FEIMEC articolo	pollici	L mm		Euro
1992-1-3/8 DSKT	1-3/8"	75	1	136,50
1992-1-7/16 DSKT	1-7/16"	80	1	141,75
1992-1-9/16 DSKT	1-9/16"	80	1	141,75
1992-1-11/16 DSKT	1-11/16"	80	1	141,75
1992-1-3/4 DSKT	1-3/4"	80	1	141,75
1992-1-7/8 DSKT	1-7/8"	80	1	147,00
1992-1-15/16 DSKT	1-15/16"	80	1	147,00
1992-2 DSKT	2"	80	1	147,00
1992-2-1/16 DSKT	2-1/16"	90	1	147,00
1992-2-1/8 DSKT	2-1/8"	90	1	147,00
1992-2-3/16 DSKT	2-3/16"	90	1	152,25
1992-2-1/4 DSKT	2-1/4"	90	1	152,25
1992-2-5/16 DSKT	2-5/16"	90	1	168,00
1992-2-3/8 DSKT	2-3/8"	96	1	168,00
1992-2-7/16 DSKT	2-7/16"	96	1	189,00
1992-2-1/2 DSKT	2-1/2"	96	1	204,75
1992-2-5/8 DSKT	2-5/8"	100	1	204,75
1992-2-11/16 DSKT	2-11/16"	100	1	231,00
1992-2-13/16 DSKT	2-13/16"	105	1	304,50
1992-2-7/8 DSKT	2-7/8"	105	1	304,50
1992-3 DSKT	3"	110	1	357,00
1992-3-1/8 DSKT	3-1/8"	115	1	367,50
1992-3-1/4 DSKT	3-1/4"	116	1	399,00
1992-3-1/2 DSKT	3-1/2"	118	1	414,75



1-1/2"



ESAGONO

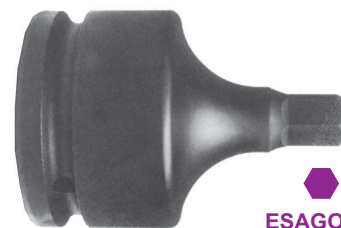

BUSSOLE ESAGONALI MASCHIO BRUNITE INTEGRI CON FORO NEL QUADRO PER SPINA E ANELLO

attacco: 1 1/2"

impronta: ESAGONO

FEIMEC articolo	mm	L mm		Euro
182 - 1-1/2" - 22	22	120	1	141,75
182 - 1-1/2" - 24	24	120	1	141,75
182 - 1-1/2" - 27	27	120	1	141,75
182 - 1-1/2" - 30	30	120	1	141,75
182 - 1-1/2" - 32	32	120	1	141,75
182 - 1-1/2" - 36	36	120	1	168,00
182 - 1-1/2" - 41	41	120	1	168,00
182 - 1-1/2" - 46	46	120	1	168,00
182 - 1-1/2" - 50	50	120	1	168,00
182 - 1-1/2" - 55	55	120	1	168,00



1-1/2"



32 mm



BUSSOLA PORTAINSERTI 32 mm

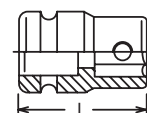

Koken articolo	mm	L mm		Euro
17108	32	85	1	211,26



32 mm.



ESAGONO

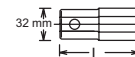

INSERTO CON MASCHIO ESAGONALE

attacco: 32 mm

impronta: ESAGONO

Koken articolo	mm	L mm		Euro
107-32-19	19	60	1	28,49
107-32-22	22	60	1	28,49
107-32-24	24	60	1	28,49
107-32-27	27	60	1	28,49
107-32-30	30	60	1	28,49
107-32-32	32	60	1	28,49
107-32-36	36	60	1	34,90

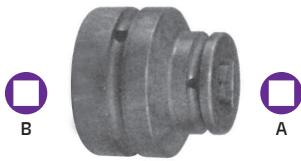

RIDUZIONI PER BUSSOLE
"POWER IMPACT" FEMMINA/FEMMINA

FEFMEC articolo	B	A	L mm		Euro
AN 2416	1 1/2"	1"	83	1	252,00
AN 2424	1 1/2"	1-1/2"	85	1	231,00

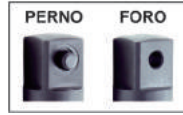
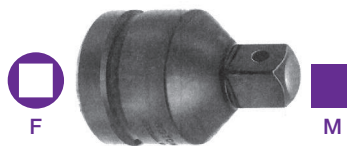

RACCORDI DI RIDUZIONE "POWER IMPACT" MASCHIO/FEMMINA

FEFMEC articolo	F	M	L mm		Euro
96-00	PERNO 1/4"	3/8"	32	1	12,47
⚠ 96-0	PERNO 3/8"	1/4"	35	1	12,47
96-1	PERNO 3/8"	1/2"	45	1	12,47
⚠ 96-01	PERNO 1/2"	1/4"	38	1	13,00
⚠ 96-2	PERNO 1/2"	3/8"	45	1	13,56
96-3	FORO 5/8"	1/2"	50	1	20,07
⚠ 96-4	PERNO 3/4"	1/2"	70	1	23,32
96-5	FORO 3/4"	5/8"	70	1	26,58
96-6	FORO 5/8"	3/4"	70	1	20,61
96-7	FORO 1/2"	5/8"	50	1	16,26
96-8	FORO 3/4"	1"	70	1	28,74
⚠ 96-9	FORO 1"	3/4"	70	1	35,79
⚠ 96-10	PERNO 1"	1/2"	70	1	65,00
96-11	FORO 1/2"	3/4"	50	1	17,89
⚠ 96-12	FORO 1 1/2"	1"	115	1	121,80
96-13	FORO 1"	1 1/2"	115	1	51,51
96-14	FORO 2 1/2"	1 1/2"	115	1	379,60
⚠ 96-15	FORO 1 1/2"	2 1/2"	120	1	260,30
⚠ 96-16	FORO 1 1/4"	1"	140	1	126,00
96-17	FORO 1 3/4"	1 1/2"	150	1	294,00

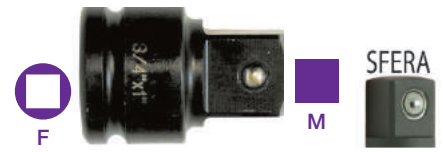

RACCORDI DI RIDUZIONE "POWER IMPACT" MASCHIO/FEMMINA CON SFERA DI TENUTA NEL QUADRO MASCHIO

FEFMEC articolo	F	M	L mm		Euro
696-00 S	1/4"	3/8"	26	1	10,00
⚠ 696-0 S	3/8"	1/4"	32	1	10,00
⚠ 696-01 S	1/2"	1/4"	36	1	10,00
696-1 S	3/8"	1/2"	36	1	10,00
⚠ 696-2 S	1/2"	3/8"	38	1	10,50
696-11 S	1/2"	3/4"	48	1	12,60
⚠ 696-4 S	3/4"	1/2"	56	1	16,80
696-8 S	3/4"	1"	63	1	22,05
⚠ 696-9 S	1"	3/4"	75	1	28,35



RACCORDO DI RIDUZIONE QUADRO MASCHIO 1" E FEMMINA 1.1/2"

attacco: 1 1/2"

Koken articolo	L mm		Euro
17788A	97	1	212,88



RACCORDO DI RIDUZIONE QUADRO MASCHIO 2.1/2" E FEMMINA 1.1/2"

attacco: 1 1/2"

Koken articolo	L mm		Euro
17799A	115	1	616,22

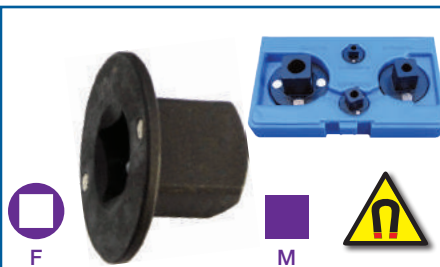

RACCORDI DI RIDUZIONE MAGNETICI "POWER IMPACT" A SCOMPARSA - SPAZI RIDOTTI

FEFMEC articolo	F	M	L mm		Euro
698-00	1/4"	3/8"	17	1	10,00
698-0	1/4"	1/2"	22	1	10,00
698-1	3/8"	1/2"	22	1	10,50
698-11	1/2"	3/4"	30	1	14,70
698-8	3/4"	1"	35	1	21,00
698-13	1"	1 1/2"	50	1	31,50
698-15	1 1/2"	2 1/2"	60	1	210,00

698	CASSETTA 4 PZ. CONTENUTO: 1 PZ. 698-00 1 PZ. 698-1 1 PZ. 698-11 1 PZ. 698-8			1	63,00
-----	---	--	--	---	-------



SPINE ACCIAIO PER BUSSOLE

Koken articolo	F	L mm		Euro
1200 A	1/4"	10,2	1	0,44
1301 A	3/8"	14,5	1	0,44
1302 A	3/8"	17,5	1	0,44
1401 A	1/2"	20	1	0,74
1402 A	1/2"	25	1	0,74
1500 A	5/8"	30	1	0,74
1601 A	3/4"	35	1	0,83
1602 A	3/4"	45	1	0,94
1801 A	1"	45	1	0,94
1802 A	1"	75	1	1,82
1701 A	1 1/2"	75	1	1,98
1702 A	1 1/2"	110	1	3,99
1901 A	2 1/2"	110	1	4,46
1902 A	2 1/2"	155	1	5,06
2001 A	3 1/2"	155	1	8,36
2002 A	3 1/2"	180	1	6,90



ARTICOLO NON SOGGETTO A GARANZIA



2-1/2"

ESAGONO

BUSSOLE ESAGONALI A RICHIESTA MISURE IN POLLICI E LUNGHE

attacco: 2 1/2"

impronta: ESAGONO

FEARMEC articolo	mm	L mm		Euro
1993-46	46	125	1	386,28
1993-50	50	125	1	386,28
1993-55	55	125	1	386,28
1993-60	60	125	1	386,28
1993-65	65	125	1	386,28
1993-70	70	125	1	386,28
1993-75	75	125	1	386,28
1993-80	80	125	1	386,28
1993-85	85	132	1	428,53
1993-90	90	132	1	482,85
1993-95	95	140	1	543,21
1993-100	100	142	1	591,50
1993-105	105	146	1	600,54
1993-110	110	155	1	663,93
1993-115	115	158	1	754,46
1993-120	120	160	1	838,88
1993-125	125	165	1	844,99
1993-130	130	169	1	935,53
1993-135	135	175	1	965,70
1993-140	140	180	1	1056,23
1993-145	145	183	1	1056,23
1993-150	150	192	1	1116,57
1993-155	155	196	1	1116,57
1993-160	160	200	1	1509,90
1993-165	165	204	1	1569,26
1993-170	170	207	1	1599,43
1993-175	175	211	1	1689,96
1993-180	180	214	1	1780,51
1993-185	185	218	1	2142,63
1993-190	190	220	1	2806,55
1993-200	200	225	1	3500,64
1993-210	210	235	1	3621,36

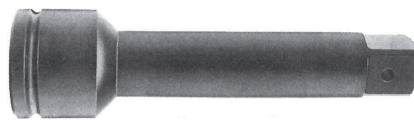

2-1/2"

FORO

2-1/2"

PROLUNGHE PER BUSSOLE "POWER IMPACT" MASCHIO/FEMMINA

attacco: 2 1/2"

FEARMEC articolo	M	F	L mm		Euro
97-23	2-1/2"	2-1/2"	250	1	619,50
97-25	2-1/2"	2-1/2"	500	1	934,50

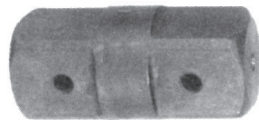

2-1/2"

2-1/2"

PROLUNGHE PER BUSSOLE "POWER IMPACT" MASCHIO/MASCHIO

attacco: 2 1/2"

FEARMEC articolo	M	M	L mm		Euro
Z4005	2-1/2"	2-1/2"	127	1	180,00



2-1/2"

2-1/2"

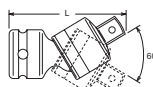

FORO

SNODO A CARDANO "POWER IMPACT"

attacco: 2 1/2"

Koken articolo	M	F	L mm		Euro
19770	2-1/2"	2-1/2"	303	1	2925,84

F

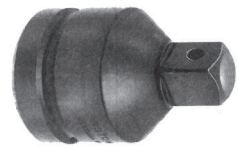

M



RACCORDI DI RIDUZIONE "POWER IMPACT" MASCHIO/FEMMINA

FEARMEC articolo	F	M	L mm		Euro
96-00	PERNO 1/4"	3/8"	32	1	12,47
96-0	PERNO 3/8"	1/4"	35	1	12,47
96-1	PERNO 3/8"	1/2"	45	1	12,47
96-01	PERNO 1/2"	1/4"	38	1	13,00
96-2	PERNO 1/2"	3/8"	45	1	13,56
96-3	FORO 5/8"	1/2"	50	1	20,07
96-4	PERNO 3/4"	1/2"	70	1	23,32
96-5	FORO 3/4"	5/8"	70	1	26,58
96-6	FORO 5/8"	3/4"	70	1	20,61
96-7	FORO 1/2"	5/8"	50	1	16,26
96-8	FORO 3/4"	1"	70	1	28,74
96-9	FORO 1"	3/4"	70	1	35,79
96-10	PERNO 1"	1/2"	70	1	65,00
96-11	FORO 1/2"	3/4"	50	1	17,89
96-12	FORO 1 1/2"	1"	115	1	121,80
96-13	FORO 1"	1 1/2"	115	1	51,51
96-14	FORO 2 1/2"	1 1/2"	115	1	379,60
96-15	FORO 1 1/2"	2 1/2"	120	1	260,30
96-16	FORO 1 1/4"	1"	140	1	126,00
96-17	FORO 1 3/4"	1 1/2"	150	1	294,00



**ARTICOLO NON
SOGGETTO A
GARANZIA**

FILETTI RIPORTATI ELICOIDI

PG **89**

Filetti riportati elicoidi



PG **94**

Kit ripristina filetti

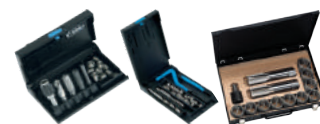

PG **110**

Utensili per il montaggio



PG **113**

Attrezzi rottura codolo



PG **113**

Estrattori



PG **114**

Maschi



PG **122**

Punte



PG **125**

Ripristino filetti per candele e sonde



PG **126**

Tappi filettati per olio



PG **130**

Bussole auto-filettanti



PG **131**

Kit bussole auto-filettanti

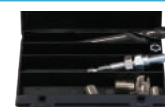

PG **132**

Utensili avvita bussole





FORATURA

Eliminare il filetto danneggiato con una punta normale. I nostri kit includono punte fino a M12. Nella sostituzione di una candela non è necessario eseguire la preforatura se si usa lo speciale attrezzo combinato per foratura e taglio. Nota bene: per i maschi per laminazione sono necessari fori più grandi.

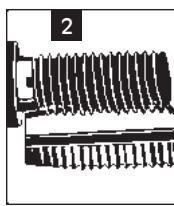

CONTROLLI

Verificare che il maschio e il bullone abbiano lo stesso filetto e lo stesso passo.

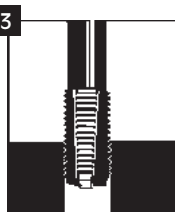

FILETTO

Utilizzando gli speciali maschi V-COIL, tagliare il filetto di presa nel foro preforato. E' consigliabile l'uso di olio da taglio adeguato.

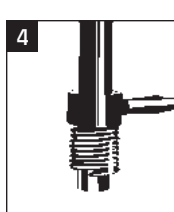

INTRODUZIONE DELL'INSERTO FILETTATO

Porre il filetto sull'attrezzo di inserimento e posizionare l'anello regolabile in modo che il perno di trascinamento si incastri nella sede dell'apertura.

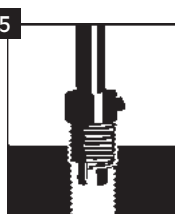

INTRODUZIONE DELL'INSERTO FILETTATO

Avvitare quindi con una leggera pressione verso il basso fino a mezzo giro sotto la superficie. Non avvitare in senso opposto al filetto per evitare rotture del codolo.

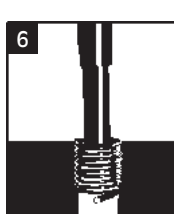

ELIMINAZIONE DEL CODOLO

Una volta terminato l'inserimento del filetto, estrarre l'attrezzo di inserimento ed eliminare il perno di trascinamento con l'attrezzo rottura codolo. Nel caso di grandi dimensioni e di candele utilizzare pinze lunghe per rimuovere il codolo. Grazie alle tolleranze ridotte e precise, il nuovo filetto risulta normalmente più forte dell'originale.

Applicazioni

Rivestimento del filetto. Per materiali teneri, per es. Le leghe di alluminio e di magnesio. Utilizzati nella costruzione di macchine, nel settore elettrico, automobilistico, medico ed aerospaziale. Riparazione di filetti danneggiati o usurati. Recupero di pezzi di scarto.

Filetti riportati

- I filetti V-Coil, costruiti con **acciaio inox al nichelcromo**, sono filetti interni estremamente robusti, resistenti a gli effetti delle temperature e della corrosione.
- Il design unico garantisce filetti di qualità superiore le cui prestazioni combinate non sono imitabili da nessun altro metodo di fissaggio singolo.
- Disponibili in due formati, a scorrimento libero o autofrenanti, i filetti V-Coil sono molto più leggeri e convenienti di qualsiasi altro tipo equivalente di filetto riportato.

Filetti a scorrimento libero - "free running"

Prodotti da profilato di precisione in acciaio inox austenitico avvolti e spirale elicoidale, i filetti riportati V-Coil hanno l'aspetto di una molla. Una volta inseriti usando un attrezzo a scelta da una selezione di utensili manuali o automatici, essi sono filetti permanenti interni resistenti al calore e alla corrosione. Quando sono posizionati, la loro posizione è mantenuta dall'azione della pressione radiale tra le bobine e i fianchi del foro filettato.

Queste pressione è data dal loro diametro libero che è maggiore, di una misura calcolata, rispetto al diametro installato.

Filetti autofrenanti - "screw locking"

I filetti autofrenanti (o con coppia prevalente) sono particolarmente validi nelle applicazioni soggette a vibrazioni cicliche o a impatti. Oltre ai vantaggi garantiti dai filetti a scorrimento libero, i filetti autofrenanti V-Coil offrono inoltre la sicurezza della coppia frenante prevalente. Questo grazie all'azione di una o più bobine di presa poligonali collocate sulla lunghezza dei filetti che esercitano una pressione radiale sul filetto maschio. Ciascuna bobina di presa è composta da un numero di filature di blocco che sporgono entro il diametro inferiore delle normali bobine a scorrimento libero. Quando il filetto maschio passa attraverso queste bobine di presa, si spostano i locking flats, esercitando una pressione radiale o coppia prevalente sul filetto maschio. Rimuovendo il filetto maschio, le bobine di presa tornano alla loro forma originale permettendo il montaggio ripetuto mantenendo un livello misurabile di coppia prevalente.

Nota: con i filetti autofrenanti si raccomanda l'uso esclusivo di bulloni o viti close fit plated o lubrificati.

Specifiche tecniche

I filetti riportati elicoidi VOLKEL sono realizzati, conformemente agli standard aeronautici, in Acciaio Inossidabile Austenitico 18/8 DTD 734A (equivalente alle specifiche SAE AS 7245, DIN/NF 2947, W.Nr. 1.4301).

Questo materiale offre una resistenza agli effetti di temperatura da -160°C a + 420°C

(con picchi fino a 500 °C), alla corrosione e allo sfregamento.

Su richiesta è possibile fornire il certificato di conformità.



Filetti Riportati acciaio inox



DIN 8140 Tolleranza ISO 2 (6H)

Diametro Nominale D		Altezza 1,0 D		Altezza 1,5 D		Altezza 2,0 D		Altezza 2,5 D		Altezza 3,0 D		
		Articolo	Euro	Articolo	Euro	Articolo	Euro	Articolo	Euro	Articolo	Euro	
Metrico												
M 2 x 0.4	100	07202	0,71	07302	0,92	07402	1,07	07502	1,20	07602	1,50	
M 2.2 x 0.45	100	07203	0,71	07303	0,92	07403	1,07	07503	1,20	07603	1,50	
M 2.5 x 0.45	100	07204	0,21	07304	0,23	07404	0,24	07504	0,29	07604	0,35	
M 3 x 0.5	100	07205	0,21	07305	0,23	07405	0,24	07505	0,29	07605	0,35	
M 3.5 x 0.6	100	07206	0,24	07306	0,26	07406	0,27	07506	0,32	07606	0,38	
M 4 x 0.7	100	07207	0,21	07307	0,23	07407	0,24	07507	0,29	07607	0,32	
M 5 x 0.8	100	07208	0,24	07308	0,20	07408	0,27	07508	0,33	07608	0,39	
M 6 x 1.0	100	07209	0,26	07309	0,21	07409	0,32	07509	0,38	07609	0,47	
M 7 x 1.0	100	07210	0,29	07310	0,35	07410	0,38	07510	0,45	07610	0,54	
M 8 x 1.25	100	07211	0,27	07311	0,27	07411	0,38	07511	0,45	07611	0,54	
M 8 x 1.0	100	07212	0,32	07312	0,32	07412	0,41	07512	0,48	07612	0,59	
M 9 x 1.25	100	07213	0,38	07313	0,51	07413	0,51	07513	0,56	07613	0,66	
M 9 x 1.0 NEW	100			07314	0,60							
M 10 x 1.5	100	07215	0,35	07315	0,38	07415	0,44	07515	0,53	07615	0,63	
M 10 x 1.25	100	07216	0,35	07316	0,38	07416	0,44	07516	0,53	07616	0,63	
M 10 x 1.0	100	07217	0,35	07317	0,38	07417	0,44	07517	0,53	07617	0,63	
M 11 x 1.5	100	07219	0,57	07319	0,65	07419	0,69	07519	0,84	07619	0,95	
M 12 x 1.75	100	07221	0,51	07321	0,59	07421	0,66	07521	0,78	07621	0,95	
M 12 x 1.5	100	07222	0,51	07322	0,59	07422	0,66	07522	0,78	07622	0,95	
M 12 x 1.25	100	07223	0,51	07323	0,59	07423	0,66	07523	0,78	07623	0,95	
M 12 x 1.0	100	07224	0,51	07324	0,59	07424	0,66	07524	0,78	07624	0,95	
M 14 x 2.0	50	07225	0,72	07325	0,83	07425	0,86	07525	1,04	07625	1,26	
M 14 x 1.5	50	07226	0,72	07326	0,83	07426	0,86	07526	1,04	07626	1,26	
M 14 x 1.25	50	07227	0,72	07327	0,83	07427	0,86	07527	1,04	07627	1,26	
M 14 x 1.0	50	07231	0,87	07331	0,90	07431	1,04	07531	1,26	07631	1,50	
M 16 x 2.0	50	07234	0,98	07334	1,02	07434	1,26	07534	1,38	07634	1,50	
M 16 x 1.5	50	07235	0,98	07335	1,02	07435	1,26	07535	1,38	07635	1,50	
M 18 x 2.5	25	07236	1,43	07336	1,65	07436	2,25	07536	2,55	07636	3,00	
M 18 x 2.0	25	07237	1,43	07337	1,65	07437	2,25	07537	2,55	07637	3,00	
M 18 x 1.5	25	07238	1,43	07338	1,65	07438	2,25	07538	2,55	07638	3,00	
M 20 x 2.5	25	07239	1,65	07339	2,10	07439	2,70	07539	3,00	07639	3,45	
M 20 x 2.0	25	07240	1,65	07340	2,10	07440	2,70	07540	3,00	07640	3,45	
M 20 x 1.5	25	07241	1,65	07341	2,10	07441	2,70	07541	3,00	07641	3,45	
M 22 x 2.5	10	07242	1,80	07342	2,25	07442	2,85	07542	3,30	07642	3,75	
M 22 x 2.0	10	07243	1,80	07343	2,25	07443	2,85	07543	3,30	07643	3,75	
M 22 x 1.5	10	07244	1,80	07344	2,25	07444	2,85	07544	3,30	07644	3,75	
M 24 x 3.0	10	07245	2,25	07345	2,40	07445	3,00	07545	3,60	07645	4,20	
M 24 x 2.0	10	07246	2,25	07346	2,40	07446	3,00	07546	3,60	07646	4,20	
M 24 x 1.5	10	07247	2,25	07347	2,40	07447	3,00	07547	3,60	07647	4,20	

 **Misure da M26 a M52 nella pagina successiva**

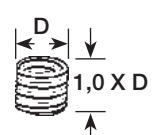
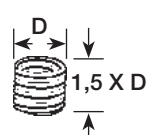
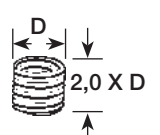
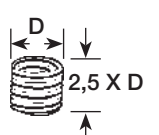
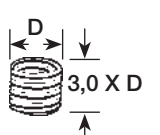
Altezza 1,0 D	Altezza 1,5 D	Altezza 2,0 D	Altezza 2,5 D	Altezza 3,0 D
				



La misura dell'altezza è sempre riferita al Filetto Riportato Elicoide installato nella sua sede.

Filetti Riportati acciaio inox



DIN 8140 Tolleranza ISO 2 (6H)

Diametro Nominale D		Altezza 1,5 D Articolo	Euro
Metrico			
M 26 x 1.5	5	07349	4,50
M 27 x 3.0	5	07350	4,50
M 27 x 2.0	5	07351	4,50
M 27 x 1.5	5	07352	4,50
M 28 x 1.5	5	07353	4,50
M 30 x 3.5	5	07354	5,50
M 30 x 2.0	5	07355	5,50
M 30 x 1.5	5	07356	5,50
M 33 x 3.5	5	07357	6,50
M 33 x 2.0	5	07358	6,50
M 36 x 4.0	5	07360	6,50
M 36 x 3.0	5	07361	6,50
M 36 x 2.0	5	07362	6,50
M 36 x 1.5	5	07363	6,50
M 39 x 4.0	NEW	07364	14,13
M 39 x 3.0	NEW	07365	14,13
M 40 x 3.0	NEW	07368	19,78
M 42 x 4.5	NEW	07372	19,78
M 42 x 3.0	NEW	07373	19,78
M 45 x 4.5	NEW	07377	23,80
M 45 x 3.0	NEW	07378	23,80
M 48 x 5.0	NEW	07382	31,24
M 48 x 3.0	NEW	07383	23,80
M 50 x 3.0	NEW	07387	31,24
M 52 x 5.0	NEW	07390	33,47
M 52 x 3.0	NEW	07391	33,47

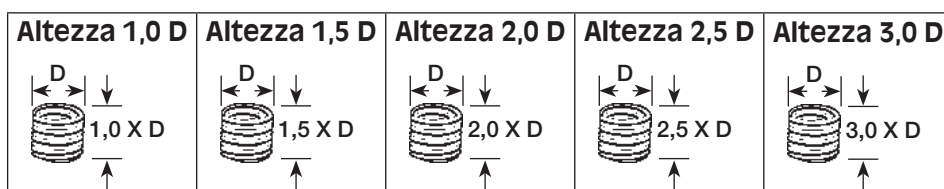

La misura dell'altezza è sempre riferita al Filetto Riportato Elicoide installato nella sua sede.

Filetti Riportati
acciaio inox
GAS



FILETTI RIPORTATI ELICOIDI

DIN 8140 **Tolleranza ISO 2 (6H)**

Diametro Nominale D		Altezza 1,5 D Articolo	Euro
GAS. (BSP)			
1/8 x 28	50	08380	0,85
1/4 x 19	50	08381	0,99
3/8 x 19	50	08382	1,29
1/2 x 14	50	08383	1,49
5/8 x 14	5	08384	4,00
3/4 x 14	5	08385	4,00
7/8 x 14	5	08386	12,00
1" x 11	5	08387	12,00

Filetti Riportati
acciaio inox



DIN 8140 **Tolleranza 2B**

Diametro Nominale D		Altezza 1,5 D Articolo	Euro
UNx8			
1.1/8 x 8	5	08731	8,00
1.1/4 x 8	5	08732	8,50
1.3/8 x 8	5	08733	10,50
1.1/2 x 8	5	08734	12,25
1.5/8 x 8	5	08735	17,50
1.3/4 x 8	5	08736	19,00
1.7/8 x 8	5	08737	20,40
2" x 8	5	08738	27,35

Filetti Riportati acciaio inox



DIN 8140 Tolleranza 2B

Diametro Nominale D		Altezza 1,0 D		Altezza 1,5 D		Altezza 2,0 D		Altezza 2,5 D		Altezza 3,0 D	
		Articolo	Euro	Articolo	Euro	Articolo	Euro	Articolo	Euro	Articolo	Euro

UNC - Passo grosso

No. 2 x 56	100	08200	1,18	08300	1,38	08400	1,78	08500	2,00	08600	2,50
No. 4 x 40	100	08201	0,45	08301	0,43	08401	0,45	08501	0,53	08601	0,63
No. 5 x 40	100	08202	0,48	08302	0,50	08402	0,53	08502	0,63	08602	0,75
No. 6 x 32	100	08203	0,35	08303	0,40	08403	0,43	08503	0,48	08603	0,55
No. 8 x 32	100	08204	0,35	08304	0,40	08404	0,43	08504	0,48	08604	0,55
No. 10 x 24	100	08205	0,45	08305	0,45	08405	0,50	08505	0,60	08605	0,73
No. 12 x 24	100	08206	0,48	08306	0,53	08406	0,58	08506	0,70	08606	0,85
1/4 x 20	100	08207	0,48	08307	0,53	08407	0,58	08507	0,70	08607	0,85
5/16 x 18	100	08208	0,63	08308	0,75	08408	0,80	08508	0,95	08608	1,15
3/8 x 16	100	08209	0,63	08309	0,98	08409	1,28	08509	1,45	08609	1,73
7/16 x 14	100	08210	0,67	08310	1,30	08410	1,48	08510	1,75	08610	2,15
1/2 x 13	100	08211	0,94	08311	1,30	08411	1,48	08511	1,75	08611	2,15
9/16 x 12	50	08212	3,75	08312	1,40	08412	6,43	08512	7,35	08612	8,88
5/8 x 11	50	08214	3,40	08314	2,83	08414	5,65	08514	6,78	08614	8,08
3/4 x 10	25	08216	3,95	08316	4,00	08416	6,70	08516	7,95	08616	9,53
7/8 x 9	10	08218	5,25	08318	6,00	08418	10,00	08518	11,83	08618	14,35
1" x 8	10	08219	5,25	08319	6,00	08419	10,00	08519	11,83	08619	14,35
1.1/8 x 7	5			08320	12,75						
1.1/4 x 7	5			08321	14,00						
1.3/8 x 6	5			08322	15,50						
1.1/2 x 6	5			08323	18,00						

UNF - Passo fine

No. 4 x 48	100	08290	1,05	08390	1,20	08490	1,60	08590	1,78	08690	2,25
No. 6 x 40	100	08291	1,05	08391	1,20	08491	1,60	08591	1,78	08691	2,25
No. 8 x 36	100	08292	1,05	08392	1,20	08492	1,60	08592	1,78	08692	2,25
No. 10 x 32	100	08293	0,45	08393	0,48	08493	0,58	08593	0,70	08693	0,85
1/4 x 28	100	08225	0,45	08325	0,48	08425	0,58	08525	0,70	08625	0,85
5/16 x 24	100	08226	0,63	08326	0,68	08426	0,80	08526	0,95	08626	1,15
3/8 x 24	100	08227	0,93	08327	0,98	08427	1,18	08527	1,43	08627	1,73
7/16 x 20	100	08228	1,15	08328	1,30	08428	1,48	08528	1,75	08628	2,15
1/2 x 20	100	08229	1,15	08329	1,30	08429	1,48	08529	1,75	08629	2,15
9/16 x 18	50	08230	2,73	08330	2,73	08430	3,28	08530	3,75	08630	4,60
5/8 x 18	50	08231	2,73	08331	2,73	08431	3,28	08531	3,75	08631	4,60
3/4 x 16	25	08233	4,50	08333	2,73	08433	7,55	08533	9,15	08633	10,98
7/8 x 14	10	08235	6,10	08335	7,10	08435	11,45	08535	13,15	08635	15,78
1" x 12	10	08237	6,10	08337	7,10	08437	11,45	08537	13,15	08637	15,78
1.1/8 x 12	5			08396	12,75						
1.1/4 x 12	5			08397	14,00						
1.3/8 x 12	5			08398	15,50						
1.1/2 x 12	5			08399	18,00						

Altezza 1,0 D	Altezza 1,5 D	Altezza 2,0 D	Altezza 2,5 D	Altezza 3,0 D



La misura dell'altezza è sempre riferita al Filetto Riportato Elicoide installato nella sua sede.

Filetti Riportati acciaio inox



DIN 8140

Diametro Nominale D		Altezza 1,0 D		Altezza 1,5 D		Altezza 2,0 D		Altezza 2,5 D		Altezza 3,0 D	
		Articolo	Euro	Articolo	Euro	Articolo	Euro	Articolo	Euro	Articolo	Euro

BSW - Withworth - Passo grosso

1/8 x 40	100	08241	0,94	08341	1,10	08441	1,80	08541	1,85	08641	2,50
3/16 x 24	100	08242	0,94	08342	1,10	08442	1,80	08542	1,85	08642	2,50
1/4 x 20	100	08243	0,52	08343	0,51	08443	0,59	08543	0,80	08643	0,85
5/16 x 18	100	08244	0,58	08344	0,60	08444	0,70	08544	0,90	08644	0,99
3/8 x 16	100	08245	0,76	08345	0,95	08445	0,99	08545	1,20	08645	1,39
7/16 x 14	100	08246	1,10	08346	1,10	08446	1,45	08546	1,50	08646	1,79
1/2 x 12	100	08247	1,10	08347	1,10	08447	1,45	08547	1,50	08647	1,79
9/16 x 12	50	08248	2,35	08348	3,50	08448	3,80	08548	4,60	08648	5,90
5/8 x 11	50	08249	2,35	08349	3,50	08449	3,80	08549	4,60	08649	5,90
3/4 x 10	25	08251	2,95	08351	4,00	08451	5,10	08551	5,00	08651	6,80
7/8 x 9	10	08253	3,80	08353	5,95	08453	6,80	08553	8,50	08653	9,90
1" x 8	10	08255	4,10	08355	6,50	08455	6,80	08555	8,50	08655	9,90

BSF - Withworth - Passo fine

3/16 x 32	100	08262	0,94	08362	1,10	08462	1,80	08562	1,90	08662	1,95
1/4 x 26	100	08263	0,52	08363	0,51	08463	0,59	08563	0,79	08663	0,85
5/16 x 22	100	08265	0,58	08365	0,60	08465	0,70	08565	0,90	08665	1,10
3/8 x 20	100	08266	0,79	08366	0,95	08466	0,99	08566	1,25	08666	1,39
7/16 x 18	100	08267	0,99	08367	1,10	08467	1,45	08567	1,65	08667	1,79
1/2 x 16	100	08268	0,99	08368	1,10	08468	1,45	08568	1,65	08668	1,79
9/16 x 16	50	08269	2,85	08369	3,80	08469	3,80	08569	4,50	08669	6,50
5/8 x 14	50	08270	2,85	08370	3,80	08470	3,80	08570	4,50	08670	6,50
3/4 x 12	25	08272	2,99	08372	4,80	08472	5,10	08572	5,95	08672	7,20
7/8 x 11	10	08274	4,00	08374	5,95	08474	6,80	08574	8,90	08674	9,90
1" x 10	10	08276	4,00	08376	5,95	08476	6,80	08576	8,90	08676	9,90

Filetti Riportati Autofrenanti - SL

acciaio inox
Colore Rosso

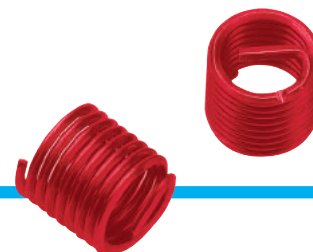

DIN 8140 Tolleranza ISO 2 (6H)

Diametro Nominale D		Altezza 1,0 D		Altezza 1,5 D		Altezza 2,0 D	
		Articolo	Euro	Articolo	Euro	Articolo	Euro

Metrico

M 3 x 0.5	100	05205	0,34	05305	0,36	05405	0,38
M 4 x 0.7	100	05207	0,34	05307	0,36	05407	0,38
M 5 x 0.8	100	05208	0,38	05308	0,40	05408	0,44
M 6 x 1.0	100	05209	0,42	05309	0,46	05409	0,50
M 8 x 1.25	100	05211	0,44	05311	0,50	05411	0,60
M 10 x 1.5	100	05215	0,56	05315	0,60	05415	0,70
M 12 x 1.75	100	05221	0,82	05321	0,94	05421	1,06
M 14 x 2.0	50	05225	1,16	05325	1,32	05425	1,38
M 16 x 2.0	50	05234	1,56	05334	1,64	05434	2,02

Espositore VC 900



Misure	Pezzi	Articolo	Articolo	Euro
Metrico			VC900	1942,50
M 5	5	04009		
M 6	5	04010		
M 8	5	04012		
M 10	5	04016		
M 12	5	04021		
M 14 x 1.25	3	04096		
M 5 - 12	3	04081		

Kit ripristina filetti con attacco 1/4"

Filetti Riportati 1,5 D

Metrico Attacco 1/4"







						Articolo	Euro
Metrico	Ø	Articolo	Articolo				
M 2.5 x 0.45	2.6 mm	08090	07090	1/4"	10	04303	30,45
M 3 x 0.5	3.2 mm	08091	07091	1/4"	10	04305	30,45
M 4 x 0.7	4.2 mm	08092	07092	1/4"	10	04307	30,45
M 5 x 0.8	5.2 mm	08093	07093	1/4"	10	04309	31,50
M 6 x 1.0	6.3 mm	08094	07094	1/4"	10	04310	33,60
M 8 x 1.25	8.3 mm	08095	07095	1/4"	10	04312	42,00
M 10 x 1.5	10.4 mm	08096	07096	1/4"	10	04316	46,20
M 12 x 1.75	12.4 mm	08097	07097	1/4"	6	04321	51,45

Kit ripristina filetti

Filetti Riportati 1,5 D

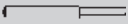

Metrico

							Articolo	Euro
Metrico		\emptyset						
M 2 x 0.4		2.1 mm	08002	07002	20		04001	31,82
M 2.5 x 0.45		2.6 mm	08003	07003	20		04003	31,82
M 3 x 0.5		3.2 mm	08004	07004	20		04005	31,82
M 3.5 x 0.6		3.7 mm	08005	07005	20		04006	31,82
M 4 x 0.7		4.2 mm	08006	07006	20		04007	31,82
M 5 x 0.8		5.2 mm	08008	07008	20		04009	32,87
M 6 x 1.0		6.3 mm	08009	07009	20		04010	34,97
M 7 x 1.0		7.3 mm	08010	07011	20		04011	43,37
M 8 x 1.25		8.3 mm	08011	07011	20		04012	43,37
M 8 x 1.0		8.3 mm	08011	07011	20		04013	43,37
M 9 x 1.0	NEW	9.3 mm	08012	07012	10		B 0091	99,00
M 9 x 1.25		9.3 mm	08012	07012	15		04014	48,62
M 10 x 1.5		10.4 mm	08013	07013	15		04016	46,52
M 10 x 1.25		10.3 mm	08013	07013	15		04017	46,52
M 10 x 1.0		10.3 mm	08013	07013	15		04018	46,52
M 11 x 1.5		11.4 mm	08014	07014	10		04019	51,77
M 12 x 1.75		12.4 mm	08015	07015	10		04021	51,77
M 12 x 1.5		12.4 mm	08015	07015	10		04022	51,77
M 12 x 1.25		12.3 mm	08015	07015	10		04023	51,77
M 12 x 1.0		12.3 mm	08015	07015	10		04024	51,77
M 14 x 2.0	vedi pag. 124 per \emptyset foro		08016	-----	10		04028	60,17
M 14 x 1.5	vedi pag. 124 per \emptyset foro		08016	-----	10		04029	60,17
M 14 x 1.25	vedi pag. 124 per \emptyset foro		08017	-----	10		04030	60,17
M 14 x 1.0	vedi pag. 124 per \emptyset foro		08017	-----	10		04031	60,17
M 16 x 2.0	vedi pag. 124 per \emptyset foro		08018	-----	10		04032	70,67
M 16 x 1.5	vedi pag. 124 per \emptyset foro		08018	-----	10		04033	70,67
M 18 x 2.5	vedi pag. 124 per \emptyset foro		08020	-----	5		04034	83,27
M 18 x 2.0	vedi pag. 124 per \emptyset foro		08020	-----	5		04035	83,27
M 18 x 1.5	vedi pag. 124 per \emptyset foro		08020	-----	5		04036	83,27
M 20 x 2.5	vedi pag. 124 per \emptyset foro		08021	-----	5		04037	90,62
M 20 x 2.0	vedi pag. 124 per \emptyset foro		08021	-----	5		04038	90,62
M 20 x 1.5	vedi pag. 124 per \emptyset foro		08021	-----	5		04039	90,62
M 22 x 2.5	vedi pag. 124 per \emptyset foro		08022	-----	5		04040	103,22
M 22 x 2.0	vedi pag. 124 per \emptyset foro		08022	-----	5		04041	103,22
M 22 x 1.5	vedi pag. 124 per \emptyset foro		08022	-----	5		04042	103,22
M 24 x 3.0	vedi pag. 124 per \emptyset foro		08023	-----	5		04043	116,96
M 24 x 2.0	vedi pag. 124 per \emptyset foro		08023	-----	5		04044	116,96
M 24 x 1.5	vedi pag. 124 per \emptyset foro		08023	-----	5		04045	116,96



Misure da M26 a M52 nella pagina successiva

Kit ripristina filetti

Set di 2 pz. maschi STI,
Utensile per il montaggio con attacco esagonale

Filetti Riportati 1,5 D



Metrico

Dimensioni					Articolo	Euro
Metrico	Articolo	Articolo	Articolo			
M 26 x 1.5	03049	08024	07349	10	04049	333,90
M 27 x 3.0	03050	08025	07350	10	04050	333,90
M 27 x 2.0	03051	08026	07351	10	04051	333,90
M 27 x 1.5	03052	08027	07352	10	04052	333,90
M 28 x 1.5	03053	08028	07353	10	04053	333,90
M 30 x 3.5	03054	08029	07354	10	04054	395,85
M 30 x 2.0	03055	08030	07355	10	04055	395,85
M 30 x 1.5	03056	08031	07356	10	04056	395,85
M 33 x 3.5	03057	08032	07357	10	04057	408,45
M 33 x 2.0	03058	08033	07358	10	04058	408,45
M 36 x 4.0	03060	08034	07360	10	04060	435,75
M 36 x 3.0	03061	08035	07361	10	04061	435,75
M 36 x 2.0	03062	08036	07362	10	04062	435,75
M 36 x 1.5	03063	08037	07363	10	04063	435,75
M 39 x 4.0	NEW 03064	08038	07364	10	04231	634,50
M 39 x 3.0	NEW 03065	08039	07365	10	04232	553,50
M 40 x 3.0	NEW 03066	08040	07368	10	04233	634,50
M 42 x 4.5	NEW 03067	08041	07372	10	04234	850,50
M 42 x 3.0	NEW 03068	08042	07373	10	04235	634,50
M 45 x 4.5	NEW 03069	08043	07377	10	04236	877,50
M 45 x 3.0	NEW 03070	08044	07378	10	04237	769,50
M 48 x 5.0	NEW 03071	08045	07382	10	04238	1073,25
M 48 x 3.0	NEW 03072	08046	07383	10	04239	796,50
M 50 x 3.0	NEW 03073	08047	07387	10	04240	850,50
M 52 x 5.0	NEW 03074	08048	07390	10	04241	1336,50
M 52 x 3.0	NEW 03075	08049	07391	10	04242	1147,50

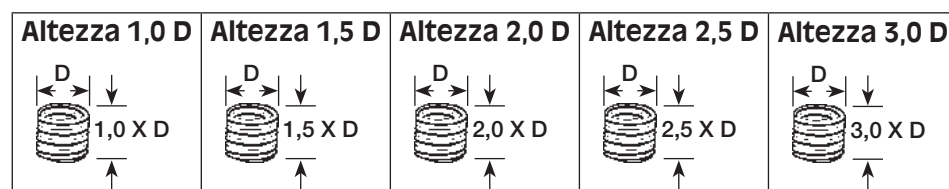

La misura dell'altezza è sempre riferita al Filetto Riportato Elicoide installato nella sua sede.



SET FILETTI RIPORTATI ELICOIDI

BGS articolo	DESCRIZIONE	Euro
BGS 1952	29 PEZZI, M5X0.8	31,88
BGS 1953	29 PEZZI, M6X1.0	34,43
BGS 1954	29 PEZZI, M8X1.25	42,08
BGS 1958	14 PEZZI, M10X1.0	54,83
BGS 1955	29 PEZZI, M10X1.5	52,28
BGS 1959	14 PEZZI, M12X1.25	57,38
BGS 1956	14 PEZZI, M12X1.75	57,38
BGS 1957	14 PEZZI, M14X1.25	70,13

CARATTERISTICHE

- contenuto: maschio HSS-G, punta HSS-G, posatore, troncatore, filetti riportati elicoidi
- in cassetta metallica



SET FILETTI RIPORTATI ELICOIDI

BGS articolo	MISURA	NR.	H mm	Euro
BGS 1959-1	M 5 X 0.8	25	6	8,93
BGS 1959-2	M 6 X 1.0	25	7	8,93
BGS 9431-1	NEW M 7 X 1.0	25	7	8,67
BGS 1959-3	M 8 X 1.25	25	9	9,88
BGS 9427-1	NEW M 8 X 1.0	25	8	9,18
BGS 9435-1	NEW M 9 X 1.25	25	10	10,20
BGS 1959-4	M 10 X 1.5	25	11	12,75
BGS 9428-1	NEW M 10 X 1.25	25	9	11,48
BGS 1958-1	M 10 X 1.0	25	10	14,54
BGS 9436-1	NEW M 11 X 1.5	10	11	6,38
BGS 1959-5	M 12 X 1.75	10	13	7,14
BGS 9429-1	NEW M 12 X 1.5	10	12	7,65
BGS 1959-7	M 12 X 1.25	10	13	7,13
BGS 9437-1	NEW M 12 X 1.0	10	12	6,38
BGS 9430-1	NEW M 14 X 1.5	10	14	8,93
BGS 1959-6	M 14 X 1.25	10	15	8,42
BGS 9432-1	NEW M 16 X 1.5	5	16	6,38
BGS 9433-1	NEW M 18 X 1.5	5	18	7,01
BGS 9434-1	NEW M 20 X 1.5	5	20	7,65
BGS 9438-1	NEW M 24 X 2.0	3	24	8,42

CARATTERISTICHE

- filetti riportati elicoidi

Kit ripristina filetti con Utensili per il Montaggio a Macchina Attacco 1/4"

Maschio STI a macchina imbocco corretto



Filetti Riportati 1,5 D

					Articolo	Euro
Metrico						
M 3 x 0.5	3.2 mm	07004	20	04070	34,93	
M 4 x 0.7	4.2 mm	07006	20	04071	34,93	
M 5 x 0.8	5.2 mm	07008	20	04072	36,07	
M 6 x 1.0	6.3 mm	07009	20	04073	38,34	
M 8 x 1.25	8.3 mm	07011	20	04074	48,83	
M 10 x 1.5	10.4 mm	07013	15	04075	52,65	
M 12 x 1.75	12.4 mm	07015	10	04076	58,75	

Kit ripristina filetti per candele



			1,5 D	Altezza 8,40 mm	Altezza 12,40 mm	Altezza 16,40 mm	Articolo	Euro
M 6 x 1.0	NEW	08009	10				04090	50,58
M 8 x 1.25	NEW	08011	10				04091	50,58
M 10 x 1.5	NEW	08013	10				04092	53,55
M 10 x 1.25	NEW	08013	10				04093	53,55
M 10 x 1.0	NEW	08013	10				04094	53,55
M 12 x 1.25		08015	10				04095	63,50
M 14 x 1.25		08017		5	5	5	04096	72,00
M 18 x 1.5	NEW	08020	5				04097	87,76

Filetti Riportati per candele







Diametro Nominale D		Altezza 8,40 mm	Altezza 12,40 mm	Altezza 16,40 mm
		Articolo Euro	Articolo Euro	Articolo Euro
M 14 x 1.25	50	07128 0,84	07228 0,74	07328 0,83

Kit ripristina filetti

Filetti Riportati 1,5 D

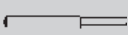

UNC - Passo Grosso





						Articolo	Euro
							
UNC	Ø						
No. 2 x 56	2.4 mm	08002	07002	20	04100	44,63	
No. 4 x 40	3.1 mm	08004	07004	20	04101	40,52	
No. 5 x 40	3.4 mm	08004	07004	20	04106	40,52	
No. 6 x 32	3.8 mm	08005	07005	20	04102	40,52	
No. 8 x 32	4.4 mm	08006	07006	20	04103	40,52	
No. 10 x 24	5.2 mm	08007	07006	20	04104	40,52	
No. 12 x 24	5.8 mm	08008	07008	20	04105	40,52	
1/4 x 20	6.7 mm	08009	07009	20	04107	36,69	
5/16 x 18	8.3 mm	08010	07011	20	04108	44,49	
3/8 x 16	9.9 mm	08012	07012	15	04109	47,32	
7/16 x 14	11.6 mm	08014	07014	10	04110	52,85	
1/2 x 13	13.0 mm	08015	07015	10	04111	57,81	
9/16 x 12	vedi pag. 124 per Ø foro	08016	-----	10	04112	76,52	
5/8 x 11	vedi pag. 124 per Ø foro	08018	-----	10	04113	76,52	
3/4 x 10	vedi pag. 124 per Ø foro	08020	-----	5	04114	97,07	
7/8 x 9	vedi pag. 124 per Ø foro	08022	-----	5	04115	117,48	
1" x 8	vedi pag. 124 per Ø foro	08023	-----	4	04116	112,10	

Kit ripristina filetti

Set di 2 pz. maschi STI,
Utensile per il montaggio con attacco esagonale

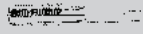
Filetti Riportati 1,5 D



Dimensioni						Articolo	Euro
							
UNC	Articolo	Articolo	Articolo				
1.1/8" x 7	03117	08050	08320	10	04117	364,35	
1.1/4" x 7	03118	08051	08321	10	04118	402,15	
1.3/8" x 6	03119	08052	08322	10	04119	450,45	
1.1/2" x 6	03120	08053	08323	10	04135	538,65	

Kit ripristina filetti

Filetti Riportati 1,5 D



UNF - Passo Fine

						Articolo	Euro
UNF - Passo fine Ø							
No. 4 x 48	3.0 mm	08004	07004	20	04120	40,52	
No. 6 x 40	3.8 mm	08005	07005	20	04121	40,52	
No. 8 x 36	4.4 mm	08006	07006	20	04122	40,52	
No. 10 x 32	5.1 mm	08008	07008	20	04123	40,52	
1/4 x 28	6.7 mm	08009	07009	20	04125	36,69	
5/16 x 24	8.3 mm	08011	07011	20	04126	44,49	
3/8 x 24	9.8 mm	08013	07013	15	04127	47,32	
7/16 x 20	11.5 mm	08014	07014	10	04128	52,85	
1/2 x 20	13.0 mm	08015	07015	10	04129	57,81	
9/16 x 18	vedi pag. 124 per Ø foro	08016	-----	10	04130	76,52	
5/8 x 18	vedi pag. 124 per Ø foro	08018	-----	10	04131	76,52	
3/4 x 16	vedi pag. 124 per Ø foro	08021	-----	5	04132	97,07	
7/8 x 14	vedi pag. 124 per Ø foro	08022	-----	5	04133	117,48	
1" x 12	vedi pag. 124 per Ø foro	08023	-----	4	04134	112,10	

Kit ripristina filetti

Set di 2 pz. maschi STI,
Utensile per il montaggio con attacco esagonale
Filetti Riportati 1,5 D



Dimensioni					Articolo	Euro
UNF - Passo fine						
1.1/8" x 12	03166	08060	08396	10	04136	364,35
1.1/4" x 12	03167	08061	08397	10	04137	402,15
1.3/8" x 12	03168	08062	08398	10	04138	450,45
1.1/2" x 12	03169	08063	08399	10	04139	538,65

Kit ripristina filetti

Filetti Riportati 1,5 D



BSW - Whitworth - Passo grosso

BSF - Whitworth - Passo fine

					Articolo	Euro
---	---	---	---	--	----------	------

BSW - Whitworth - Passo grosso

1/8 x 40	3.4 mm	08004	07004	20	04141	41,57
3/16 x 24	5.0 mm	08008	07008	20	04142	41,57
1/4 x 20	6.7 mm	08009	07009	20	04143	37,74
5/16 x 18	8.3 mm	08010	07011	20	04144	45,54
3/8 x 16	9.9 mm	08012	07012	15	04145	48,37
7/16 x 14	11.5 mm	08014	07014	10	04146	53,90
1/2 x 12	13.0 mm	08015	07015	10	04147	58,86
9/16 x 12	vedi pag. 124 per Ø foro	08016	-----	10	04148	77,57
5/8 x 11	vedi pag. 124 per Ø foro	08018	-----	10	04149	77,57
3/4 x 10	vedi pag. 124 per Ø foro	08020	-----	5	04150	98,12
7/8 x 9	vedi pag. 124 per Ø foro	08022	-----	5	04151	118,53
1" x 8	vedi pag. 124 per Ø foro	08023	-----	4	04152	113,15

BSF - Whitworth - Passo fine

3/16 x 32	5.0 mm	08007	07006	20	04162	41,57
1/4 x 26	6.6 mm	08009	07009	20	04163	37,74
5/16 x 22	8.3 mm	08011	07011	20	04165	45,54
3/8 x 20	9.9 mm	08013	07013	15	04166	48,37
7/16 x 18	11.5 mm	08014	07014	10	04167	53,90
1/2 x 16	13.0 mm	08015	07015	10	04168	58,86
9/16 x 16	vedi pag. 124 per Ø foro	08016	-----	10	04169	77,57
5/8 x 14	vedi pag. 124 per Ø foro	08018	-----	10	04170	77,57
3/4 x 12	vedi pag. 124 per Ø foro	08020	-----	5	04172	98,12
7/8 x 11	vedi pag. 124 per Ø foro	08022	-----	5	04174	118,53
1" x 10	vedi pag. 124 per Ø foro	08023	-----	4	04176	113,15

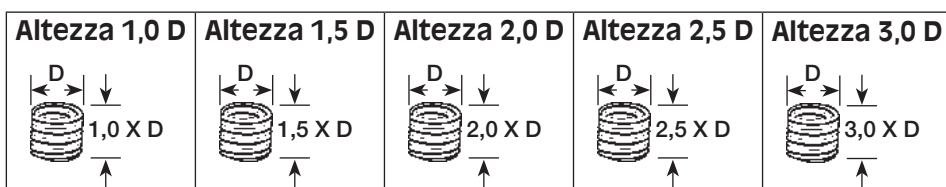

La misura dell'altezza è sempre riferita al Filetto Riportato Elicoide installato nella sua sede.

Kit ripristina filetti

Set di 2 pz. maschi STI,
Utensile per il montaggio con attacco esagonale

Filetti Riportati 1,5 D

GAS



FILETTI RIPORTATI ELICOIDI

Dimensioni					Articolo	Euro
Gas (BSP)	Articolo	Articolo	Articolo			
G 1/8 x 28	03311	08080	08380	10	04190	84,53
G 1/4 x 19	03312	08081	08381	10	04191	95,24
G 3/8 x 19	03313	08082	08382	10	04192	104,48
G 1/2 x 14	03314	08083	08383	10	04193	133,35
G 5/8 x 14	03315	08084	08384	10	04194	271,95
G 3/4 x 14	03316	08085	08385	10	04195	271,95
G 7/8 x 14	03318	08086	08386	10	04196	376,95
G 1" x 11	03317	08087	08387	10	04197	381,15

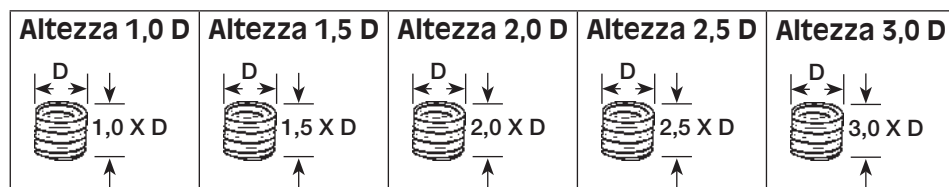

La misura dell'altezza è sempre riferita al Filetto Riportato Elicoide installato nella sua sede.

Kit ripristina filetti





Set di 2 pz. maschi STI,
Utensile per il montaggio con attacco esagonale

Filetti Riportati 1,5 D

UNx8

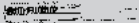

FILETTI RIPORTATI ELICOIDI

Dimensioni					Articolo	Euro
UNx8	Articolo	Articolo	Articolo			
1.1/8 x 8	03191	08741	08731	10	04731	367,50
1.1/4 x 8	03192	08742	08732	10	04732	404,25
1.3/8 x 8	03193	08743	08733	10	04733	357,00
1.1/2 x 8	03194	08744	08734	10	04734	556,50
1.5/8 x 8	03195	08745	08735	10	04735	598,50
1.3/4 x 8	03196	08746	08736	10	04736	729,75
1.7/8 x 8	03197	08747	08737	10	04737	729,75
2" x 8	03198	08748	08738	10	04738	1048,95

Kit ripristina filetti

NEW

**Filetti Riportati 1,0 D - 1,5 D - 2,0 D
con giramaschi**

Metrico



FILETTI RIPORTATI ELICOIDI

				1,0	1,5	2,0	Articolo	Euro
--	--	--	--	-----	-----	-----	----------	------

M 5 - M 12							04080	215,00
M 5 x 0.8	5.2 mm	08008	07008	10	10	10		
M 6 x 1.0	6.3 mm	08009	07009	10	10	10		
M 8 x 1.25	8.3 mm	08011	07011	10	10	10		
M 10 x 1.5	10.4 mm	08013	07013	10	10	10		
M 12 x 1.75	12.4 mm	08015	07015	5	5	5		

Altezza 1,0 D	Altezza 1,5 D	Altezza 2,0 D	Altezza 2,5 D	Altezza 3,0 D



La misura dell'altezza è sempre riferita al Filetto Riportato Elicoide installato nella sua sede.

Kit ripristina filetti V-COIL rapid con Utensili Attacco 1/4"

Filetti Riportati 1,5 D

Metrico
Attacco 1/4"

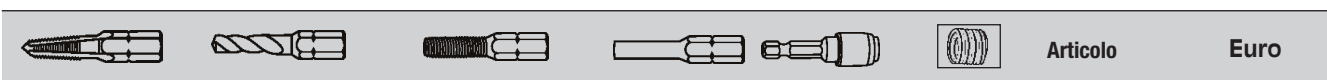

M 5 - M 12	Ø	Articolo	Articolo			Articolo	Euro
M 5 x 0.8	5.2 mm	08093	07093	1/4"	10	04381	211,92
M 6 x 1.0	6.3 mm	08094	07094	1/4"	10		
M 8 x 1.25	8.3 mm	08095	07095	1/4"	10		
M 10 x 1.5	10.4 mm	08096	07096	1/4"	10		
M 12 x 1.75	12.4 mm	08097	07097	1/4"	10		

M 6 - M 10						Articolo	Euro
M 6 x 1.0	6.3 mm	08094	07094	1/4"	10	04385	134,40
M 8 x 1.25	8.3 mm	08095	07095	1/4"	10		
M 10 x 1.5	10.4 mm	08096	07096	1/4"	10		

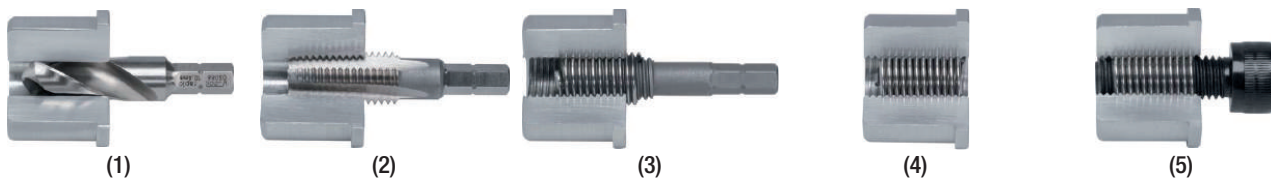

1/4"

Kit ripristina filetti

Filetti Riportati 1,5 D

Metrico



					Articolo	Euro
M 5 - M 12					04081	199,00
M 5 x 0.8	5.2 mm	08008	07008	25		
M 6 x 1.0	6.3 mm	08009	07009	25		
M 8 x 1.25	8.3 mm	08011	07011	25		
M 10 x 1.5	10.4 mm	08013	07013	25		
M 12 x 1.75	12.4 mm	08015	07015	10		
M 6 - M 14 x 1.25 / NP					04082	233,60
M 6 x 1.0	6.3 mm	08009	07009	25		
M 8 x 1.25	8.3 mm	08011	07011	25		
M 10 x 1.5	10.4 mm	08013	07013	25		
M 12 x 1.75	12.4 mm	08015	07015	10		
M 14 x 1.25		08017		10		
M 6 - M 14 x 1.25 / PT (*Speciale per candele)					04083	246,75
M 6 x 1.0	6.3 mm	08009	07009	25		
M 8 x 1.25	8.3 mm	08011	07011	25		
M 10 x 1.5	10.4 mm	08013	07013	25		
M 12 x 1.75	12.4 mm	08015	07015	10		
M 14 x 1.25*		08017		10		
M 6 - M 10					04085	137,55
M 6 x 1.0	6.3 mm	08009	07009	25		
M 8 x 1.25	8.3 mm	08011	07011	25		
M 10 x 1.5	10.4 mm	08013	07013	25		



PRO+

BGS articolo	DESCRIZIONE	Euro
BGS 1950	SET 130 PEZZI, FILETTI RIPORTATI ELICOIDI, M5 - M6 - M8 - M10 - M12	161,25

CARATTERISTICHE

- comprende per ogni misura: maschio HSS-G, punta HSS-G, posatore, troncatore
- comprende 110 filetti riportati elicoidi così suddivisi:
 - 25 pezzi per misura: M5x0.80 - M6x1.00 - M8x1.25 - M10x1.50
 - 10 pezzi per misura: M12x1.75



BGS articolo	DESCRIZIONE	Euro
BGS 19500	SET 130 PEZZI, FILETTI RIPORTATI ELICOIDI, M5 - M6 - M8 - M10 - M12	129,87

CARATTERISTICHE

- comprende per ogni misura: maschio HSS-G, punta HSS-G, posatore, troncatore
- comprende 110 filetti riportati elicoidi così suddivisi:
 - 25 pezzi per misura: M5x0.80 - M6x1.00 - M8x1.25 - M10x1.50
 - 10 pezzi per misura: M12x1.75



PRO+

BGS articolo	DESCRIZIONE	Euro
BGS 1951	SET 130 PEZZI, FILETTI RIPORTATI ELICOIDI, M6 - M8 - M10 - M12 - M14	193,75

CARATTERISTICHE

- comprende per ogni misura: maschio HSS-G, punta HSS-G, posatore, troncatore
- comprende 110 filetti riportati elicoidi così suddivisi:
 - 25 pezzi per misura: M6x1.00-M8x1.25-M14x1.25
 - 20 pezzi per misura: M10x1.5
 - 15 pezzi per misura: M12x1.75

1 KIT RIPRISTINA FILETTI

Kit ripristina filetti

Filetti Riportati 1,5 D

UNC
UNF
BSW
BSF



FILETTI RIPORTATI ELICOIDI

					Articolo	Euro
UNC 1/4 - 1/2"					04184	265,95
UNC 1/4 x 20	6.7 mm	08009	07009	25		
UNC 5/16 x 18	8.3 mm	08010	07011	25		
UNC 3/8 x 16	9.9 mm	08012	07012	25		
UNC 7/16 x 14	11.6 mm	08014	07014	10		
UNC 1/2 x 13	13.0 mm	08015	07015	10		
UNF 1/4 - 1/2"					04185	265,95
UNF 1/4 x 28	6.7 mm	08009	07009	25		
UNF 5/16 x 24	8.3 mm	08011	07011	25		
UNF 3/8 x 24	9.8 mm	08013	07013	25		
UNF 7/16 x 20	11.5 mm	08014	07014	10		
UNF 1/2 x 20	13.0 mm	08015	07015	10		
BSW 1/4 - 1/2"					04186	265,95
BSW 1/4 x 20	6.7 mm	08009	07009	25		
BSW 5/16 x 18	8.3 mm	08010	07011	25		
BSW 3/8 x 16	9.9 mm	08012	07012	25		
BSW 7/16 x 14	11.5 mm	08014	07014	10		
BSW 1/2 x 12	13.0 mm	08015	07015	10		
BSF 1/4 - 1/2"					04187	265,95
BSF 1/4 x 26	6.6 mm	08009	07009	25		
BSF 5/16 x 22	8.3 mm	08011	07011	25		
BSF 3/8 x 20	9.9 mm	08012	07012	25		
BSF 7/16 x 18	11.5 mm	08014	07014	10		
BSF 1/2 x 16	13.0 mm	08015	07015	10		

Kit ripristina filetti con Utensili per il Montaggio a Macchina Attacco 1/4"

con Maschi STI a Macchina imbocco corretto

Filetti Riportati 1,5 D



Metrico

					Articolo	Euro
					04087	255,15
M 5 - M 12						
M 5 x 0.8	5.2 mm	08072	07008	25		
M 6 x 1.0	6.3 mm	08073	07009	25		
M 8 x 1.25	8.3 mm	08074	07011	25		
M 10 x 1.5	10.4 mm	08075	07013	25		
M 12 x 1.75	12.4 mm	08076	07015	10		

Kit ripristina filetti con Utensili per il Montaggio a Macchina Attacco 1/4"

Maschio STI a macchina imbocco corretto

Filetti Riportati 1,5 D



					Articolo	Euro
Metrico						
M 3 x 0.5	3.2 mm	07004	20	04070	34,93	
M 4 x 0.7	4.2 mm	07006	20	04071	34,93	
M 5 x 0.8	5.2 mm	07008	20	04072	36,07	
M 6 x 1.0	6.3 mm	07009	20	04073	38,34	
M 8 x 1.25	8.3 mm	07011	20	04074	48,83	
M 10 x 1.5	10.4 mm	07013	15	04075	52,65	
M 12 x 1.75	12.4 mm	07015	10	04076	58,75	

Utensile per il montaggio a macchina con attacco 1/4"

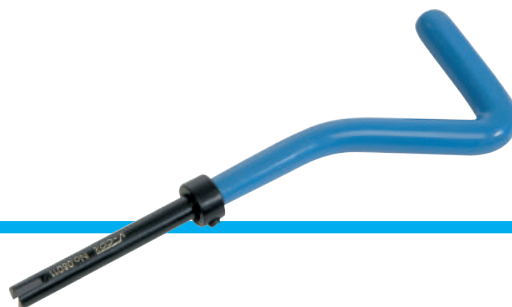

Dimensions	L 1			Articolo	Euro
Metrico					
M 3 x 0.5	46	6	1/4"	08070	13,65
M 4 x 0.7	56	7	1/4"	08071	13,65
M 5 x 0.8	62	8	1/4"	08072	13,65
M 6 x 1.0	76	10	1/4"	08073	13,65
M 8 x 1.25	85	12	1/4"	08074	16,28
M 10 x 1.5	96	14	1/4"	08075	17,75
M 12 x 1.75	107	16	1/4"	08076	19,79
M 14 x 2.0			1/4"	08077	19,50

Utensili per il montaggio
 con anello di arresto



Metrico	UNC / UNF BSW / BSF			Articolo	Euro
M 2 x 0.4 M 2.2 x 0.45	UNC	No. 2		08002	10,50
M 2.5 x 0.45				08003	10,50
M 3 x 0.5	UNC UNC/UNF	No. 5 No. 4	BSW 1/8	08004	10,50
M 3.5 x 0.6	UNC/UNF	No. 6		08005	10,50
M 4 x 0.7 BSW 3/16	UNC/UNF	No. 8		08006	10,50
	UNC	No. 10		08007	10,50
	UNF	No. 10			
M 5 x 0.8	UNC	No. 12	BSF 3/16	08008	10,50
M 6 x 1.0	UNC/UNF BSW/BSF	1/4		08009	10,50
M 7 x 1.0	UNC/BSW	5/16		08010	11,55
M 8 x 1.25					
M 8 x 1.0	UNF/BSF	5/16		08011	11,55
M 9 x 1.25					
M 9 x 1.0	UNC/BSW	3/8		08012	13,65
M 10 x 1.5					
M 10 x 1.0 M 10 x 1.25	UNF/BSF	3/8		08013	13,65
	UNC/UNF	7/16			
M 11 x 1.5	BSW/BSF	7/16		08014	14,70
M 12 x 1.75 M 12 x 1.5	UNC/UNF	1/2			
M 12 x 1.25 M 12 x 1.0	BSW/BSF	1/2		08015	14,70
M 14 x 2.0	UNC/UNF	9/16			
M 14 x 1.5	BSW/BSF	9/16		08016	16,80
M 14 x 1.25					
M 14 x 1.0				08017	16,80
M 16 x 2.0	UNC/UNF	5/8			
M 16 x 1.5	BSW/BSF	5/8		08018	18,38
M 18 x 2.5	UNC	3/4			
M 18 x 2.0 M 18 x 1.5	BSW/BSF	3/4		08020	18,38
M 20 x 2.5					
M 20 x 2.0 M 20 x 1.5	UNF	3/4		08021	18,38
M 22 x 2.5	UNC/UNF	7/8			
M 22 x 2.0 M 22 x 1.5	BSW/BSF	7/8		08022	23,10
M 24 x 3.0	UNC/UNF	1"			
M 24 x 2.0 M 24 x 1.5	BSW/BSF	1"		08023	23,10

Utensili per il montaggio con attacco esagonale



Diametro Nominale D		Articolo	Euro
Metrico			
M 2.5 x 0.4	1/4"	08090	10,50
M 3 x 0.5	1/4"	08091	10,50
M 4 x 0.7	1/4"	08092	10,50
M 5 x 0.8	1/4"	08093	10,50
M 6 x 1.0	1/4"	08094	10,50
M 8 x 1.25	1/4"	08095	11,55
M 10 x 1.5	1/4"	08096	12,60
M 12 x 1.75	1/4"	08097	14,18
M 26 x 1.5	1/2"	08024	27,30
M 27 x 3.0	1/2"	08025	27,30
M 27 x 2.0	1/2"	08026	27,30
M 27 x 1.5	1/2"	08027	27,30
M 28 x 1.5	1/2"	08028	27,30
M 30 x 3.5	1/2"	08029	30,45
M 30 x 2.0	1/2"	08030	30,45
M 30 x 1.5	1/2"	08031	30,45
M 33 x 2.0	1/2"	08032	37,80
M 33 x 4.0	1/2"	08033	37,80
M 36 x 4.0	1/2"	08034	37,80
M 36 x 3.0	1/2"	08035	37,80
M 36 x 2.0	1/2"	08036	37,80
M 36 x 1.5	1/2"	08037	37,80
M 39 x 4.0 NEW	3/4"	08038	40,50
M 39 x 3.0 NEW	3/4"	08039	40,50
M 40 x 3.0 NEW	3/4"	08040	40,50
M 42 x 4.5 NEW	3/4"	08041	47,25
M 42 x 3.0 NEW	3/4"	08042	47,25
M 45 x 4.5 NEW	3/4"	08043	47,25
M 45 x 3.0 NEW	3/4"	08044	47,25
M 48 x 5.0 NEW	3/4"	08045	49,95
M 48 x 3.0 NEW	3/4"	08046	49,95
M 50 x 3.0 NEW	3/4"	08047	56,70
M 52 x 5.0 NEW	3/4"	08048	56,70
M 52 x 3.0 NEW	3/4"	08049	56,70

Utensili per il montaggio
 con attacco esagonale

Diametro Nominale D		Articolo	Euro
UNC			
1.1/8 x 7.0	1/2"	08050	31,50
1.1/4 x 7.0	1/2"	08051	31,50
1.3/8 x 6.0	1/2"	08052	37,80
1.1/2 x 6.0	1/2"	08053	37,80
UNF			
1.1/8 x 12	1/2"	08060	31,50
1.1/4 x 12	1/2"	08061	31,50
1.3/8 x 12	1/2"	08062	35,60
1.1/2 x 12	1/2"	08063	35,60
Gas (BSP)			
1/8 x 28	1/4"	08080	15,75
1/4 x 19	1/4"	08081	15,75
3/8 x 19	1/4"	08082	18,38
1/2 x 14	1/4"	08083	19,95
5/8 x 14	1/2"	08084	24,15
3/4 x 14	1/2"	08085	24,15
7/8 x 14	1/2"	08086	35,70
1 x 11	1/2"	08087	35,70
UNx8			
1.1/8 x 8	1/2"	08741	25,65
1.1/4 x 8	1/2"	08742	25,65
1.3/8 x 8	1/2"	08743	29,90
1.1/2 x 8	1/2"	08744	29,90
1.5/8 x 8	3/4"	08745	48,25
1.3/4 x 8	3/4"	08746	56,00
1.7/8 x 8	3/4"	08746	58,00
2" x 8	3/4"	08747	67,00

Attrezzi rottura codolo

Metrico	UNC / UNF BSW / BSF	Articolo	Euro
M 2 x 0.4 M 2.2 x 0.45	UNC No. 2	07002	4,73
M 2.5 x 0.45		07003	4,73
M 3 x 0.5	UNC/UNF No. 4	07004	4,73
M 3.5 x 0.6	UNC/UNF No. 6	07005	4,73
M 4 x 0.7	UNC No. 10		
	UNF No. 8 BSF 3/16	07006	4,73
M 5 x 0.8	UNC No. 10		
	UNC No. 12 BSF 3/16	07008	4,73
M 6 x 1.0	UNC/UNF 1/4 BSW/BSF 1/4	07009	4,73
M 7 x 1.0	UNC/UNF 5/16		4,73
M 8 x 1.0 M 8 x 1.25	BSW/BSF 5/16	07011	
M 9 x 1.0 M 9 x 1.25	UNC 3/8 BSW/BSF 3/8	07012	4,73
M 10 x 1.5			
M 10 x 1.0 M 10 x 1.25	UNF 3/8	07013	4,73
M 11 x 1.5	UNC/UNF 7/16 BSW/BSF 7/16	07014	6,30
M 12 x 1.75 M 12 x 1.5	UNC/UNF 1/2		
M 12 x 1.25 M 12 x 1.0	BSW/BSF 1/2	07015	6,30

Attrezzi rottura codolo attacco 1/4"

M 2.5 x 0.4	1/4" ●	07090	6,30
M 3 x 0.5	1/4" ●	07091	6,30
M 4 x 0.7	1/4" ●	07092	6,30
M 5 x 0.8	1/4" ●	07093	6,30
M 6 x 1.0	1/4" ●	07094	6,30
M 8 x 1.25	1/4" ●	07095	6,30
M 10 x 1.5	1/4" ●	07096	6,30
M 12 x 1.75	1/4" ●	07097	6,30

Estrattori

Metrico	Pollici	Articolo	Euro
M 3 - M 10	3/16" - 3/8"	07052	17,01
M 11 - M 24	3/8" - 1"	07053	20,70
M 20 - M 39		07054	189,00
M 39 - M 65		07055	199,50

Maschi STI (Imbocco Forma D) per filetti riportati ISO 2 (6H)

Passo Metrico



Forma D HSS-G Tolleranza ISO1 (4H)

M

Diametro Nominale D	P	B	L 1	L 2	D 2	∅	Articolo	Euro
M 2	x 0.40	2.5	44.5	9.5	2.8	2.24	03001	12,60
M 2.5	x 0.45	3.1	48.0	11.0	3.15	2.50	03003	12,60
M 3	x 0.5	3.6	53.0	13.0	4.0	3.15	03005	12,60
M 3.5	x 0.6	4.3	53.0	13.0	4.5	3.55	03006	12,60
M 4	x 0.7	4.9	58.0	16.0	5.0	4.00	03007	12,60
M 5	x 0.8	6.0	66.0	19.0	6.3	5.00	03008	12,60
M 6	x 1.0	7.3	72.0	22.0	8.0	6.30	03009	12,60
M 7	x 1.0	8.3	72.0	22.0	9.0	7.10	03010	14,70
M 8	x 1.25	9.6	80.0	24.0	10.0	8.00	03011	14,70
M 8	x 1.0	9.3	80.0	24.0	10.0	8.00	03012	14,70
M 9	x 1.25	10.6	85.0	25.0	8.0	6.30	03013	16,80
M 10	x 1.5	11.9	89.0	29.0	9.0	7.10	03015	16,80
M 10	x 1.25	11.6	85.0	25.0	8.0	6.30	03016	16,80
M 10	x 1.0	11.3	85.0	25.0	8.0	6.30	03017	16,80
M 11	x 1.5	12.9	89.0	29.0	9.0	7.10	03018	22,05
M 12	x 1.75	14.3	95.0	30.0	11.2	9.00	03020	22,05
M 12	x 1.5	14.0	95.0	30.0	11.2	9.00	03021	23,10
M 12	x 1.25	13.6	95.0	30.0	11.2	9.00	03022	23,10
M 12	x 1.0	13.3	95.0	30.0	11.2	9.00	03023	23,10
M 14	x 2.0	16.6	102.0	32.0	12.5	10.00	03027	26,25
M 14	x 1.5	16.0	102.0	32.0	12.5	10.00	03028	26,25
M 14	x 1.25	15.6	102.0	32.0	12.5	10.00	03029	26,25
M 14	x 1.0	15.3	102.0	32.0	12.5	10.00	03030	26,25
M 16	x 2.0	18.6	112.0	37.0	14.0	11.20	03033	32,55
M 16	x 1.5	18.0	104.0	29.0	14.0	11.20	03034	32,55
M 18	x 2.5	21.3	118.0	38.0	16.0	12.50	03035	34,65
M 18	x 2.0	20.6	104.0	29.0	14.0	11.20	03036	34,65
M 18	x 1.5	20.0	104.0	29.0	14.0	11.20	03037	34,65
M 20	x 2.5	23.3	118.0	38.0	16.0	12.50	03038	38,85
M 20	x 2.0	22.6	113.0	33.0	16.0	12.50	03039	38,85
M 20	x 1.5	22.0	113.0	33.0	16.0	12.50	03040	38,85
M 22	x 2.5	25.3	130.0	45.0	18.0	14.00	03041	49,35
M 22	x 2.0	24.6	120.0	35.0	18.0	14.00	03042	49,35
M 22	x 1.5	24.0	120.0	35.0	18.0	14.00	03043	49,35
M 24	x 3.0	27.9	138.0	48.0	20.0	16.00	03044	52,50
M 24	x 2.0	26.6	127.0	37.0	20.0	16.00	03045	52,50
M 24	x 1.5	26.0	120.0	35.0	18.0	14.00	03046	52,50

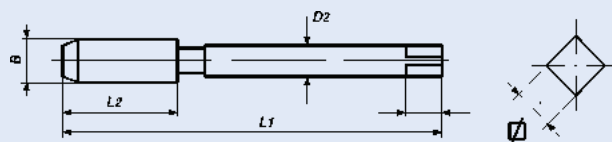

Maschi STI Set di 2 pz.
per filetti riportati ISO 2 (6H)

Passo Metrico



HSS-G Tolleranza ISO1 (4H)

M

Diametro Nominale D	P	B	L 1	L 2	D 2	∅	Articolo	Euro
M 26	x 1.5	28.0	127	37	20.0	16.0	03049	173,25
M 27	x 3.0	30.9	151	51	22.4	18.0	03050	173,25
M 27	x 2.0	29.6	127	37	20.0	16.0	03051	173,25
M 27	x 1.5	29.0	127	37	20.0	16.0	03052	173,25
M 28	x 1.5	30.0	127	37	20.0	16.0	03053	211,05
M 30	x 3.5	34.6	162	57	25.0	20.0	03054	211,05
M 30	x 2.0	32.6	137	37	22.4	18.0	03055	211,05
M 30	x 1.5	32.0	137	37	22.4	18.0	03056	211,05
M 33	x 3.5	37.6	162	57	25.0	20.0	03057	211,05
M 33	x 2.0	35.6	144	37	25.0	20.0	03058	211,05
M 36	x 4.0	41.2	170	60	28.0	22.4	03060	241,50
M 36	x 3.0	39.9	170	60	28.0	22.4	03061	241,50
M 36	x 2.0	38.6	150	39	28.0	22.4	03062	241,50
M 36	x 1.5	38.0	150	39	28.0	22.4	03063	241,50
M 39	x 4.0	NEW 44.2	187	67	31.5	28.0	03064	364,50
M 39	x 3.0	NEW 42.9	149	39	28.0	26.0	03065	310,50
M 40	x 3.0	NEW 43.9	149	39	28.0	26.0	03066	310,50
M 42	x 4.5	NEW 47.9	187	67	31.5	28.0	03067	513,00
M 42	x 3.0	NEW 45.9	165	45	31.5	28.0	03068	337,50
M 45	x 4.5	NEW 50.9	200	70	35.5	31.0	03069	513,00
M 45	x 3.0	NEW 48.9	175	45	35.5	31.0	03070	391,50
M 48	x 5.0	NEW 54.5	200	70	35.5	31.0	03071	634,50
M 48	x 3.0	NEW 51.9	175	45	35.5	31.0	03072	432,00
M 50	x 3.0	NEW 53.9	175	45	35.5	31.0	03073	472,50
M 52	x 5.0	NEW 58.5	221	76	40.0	34.0	03074	877,50
M 52	x 3.0	NEW 55.9	193	48	40.0	34.0	03075	742,50

FILETTI RIPORTATI ELICOIDI

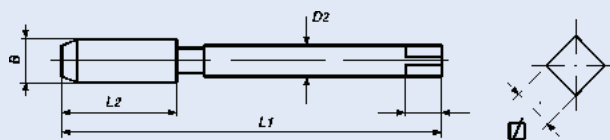

Maschi STI a macchina (Imbocco corretto) Punta Spirale per filetti riportati ISO 2 (6H)

Passo Metrico



Form B HSS-E Tolleranza ISO 1 (4H)

M

Diametro Nominale D	P	B	L 1	L 2	D 2	∅	Articolo	Euro
M 3	x 0.5	3.6	53.0	13.0	4.0	3.15	03505	16,80
M 3.5	x 0.6	4.3	53.0	13.0	4.5	3.55	03506	16,80
M 4	x 0.7	4.9	58.0	16.0	5.0	4.00	03507	16,80
M 5	x 0.8	6.0	66.0	19.0	6.3	5,00	03508	16,80
M 6	x 1.0	7.3	72.0	22.0	8.0	6.40	03509	16,80
M 7	x 1.0	8.3	72.0	22.0	9.0	7.10	03510	18,90
M 8	x 1.25	9.6	80.0	24.0	10.0	8.00	03511	18,90
M 8	x 1.0	9.3	80.0	24.0	10.0	8.00	03512	18,90
M 10	x 1.5	11.9	89.0	29.0	9.0	7.10	03515	19,95
M 10	x 1.0	11.3	85.0	25.0	8.0	6.30	03517	19,95
M 12	x 1.75	14.3	95.0	30.0	11.2	9.00	03520	22,05
M 12	x 1.5	14.0	95.0	30.0	11.2	9.00	03521	22,05
M 12	x 1.25	13.6	95.0	30.0	11.2	9.00	03522	22,05
M 14	x 2.0	16.6	102.0	32.0	12.5	10.00	03527	29,40
M 14	x 1.5	16.0	102.0	32.0	12.5	10.00	03528	29,40
M 14	x 1.25	15.6	102.0	32.0	12.5	10.00	03529	29,40
M 16	x 2.0	18.6	112.0	37.0	14.0	11.20	03533	32,55

FILETTI RIPORTATI ELICOIDI

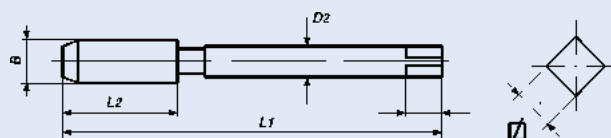

Maschi STI a macchina elicoidali per Fori Ciechi per filetti riportati ISO 2 (6H)

Passo Metrico
Form C/35°RSP
HSS-E Tolleranza ISO 1 (4H)
M

Diametro Nominale D	P	B	L 1	L 2	D 2	∅	Articolo	Euro
M 3	x 0.5	3.6	53.0	13.0	4.0	3.15	03705	15,75
M 3.5	x 0.6	4.3	53.0	13.0	4.5	3.55	03706	15,75
M 4	x 0.7	4.9	58.0	16.0	5.0	4.00	03707	15,75
M 5	x 0.8	6.0	66.0	19.0	6.3	5,00	03708	15,75
M 6	x 1.0	7.3	72.0	22.0	8.0	6.40	03709	15,75
M 7	x 1.0	8.3	72.0	22.0	9.0	7.10	03710	17,85
M 8	x 1.25	9.6	80.0	24.0	10.0	8.00	03711	17,85
M 8	x 1.0	9.3	80.0	24.0	10.0	8.00	03712	17,85
M 10	x 1.5	11.9	89.0	29.0	9.0	7.10	03715	19,95
M 10	x 1.0	11.3	85.0	25.0	8.0	6.30	03717	19,95
M 12	x 1.75	14.3	95.0	30.0	11.2	9.00	03720	21,53
M 12	x 1.5	14.0	95.0	30.0	11.2	9.00	03721	23,10
M 12	x 1.25	13.6	95.0	30.0	11.2	9.00	03722	23,10
M 14	x 2.0	16.6	102.0	32.0	12.5	10.00	03727	28,35
M 14	x 1.5	16.0	102.0	32.0	12.5	10.00	03728	28,35
M 14	x 1.25	15.6	102.0	32.0	12.5	10.00	03729	28,35
M 16	x 2.0	18.6	112.0	37.0	14.0	11.20	03733	32,55

Maschi STI a macchina a rullare per filetti riportati ISO 2 (6H)

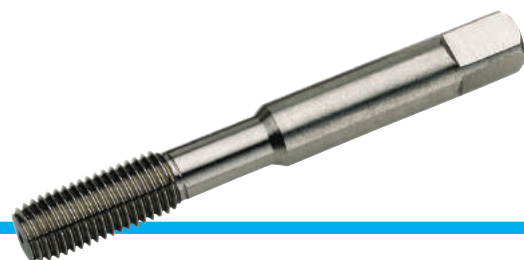
Passo Metrico

HSS-E Tolleranza ISO 1 (4H)
M

Diametro Nominale D	P	B	L 1	L 2	D 2	∅	Articolo	Euro
M 3	x 0.5	3.6	53.0	13.0	4.0	3.15	03605	15,23
M 4	x 0.7	4.9	58.0	16.0	5.0	4.00	03607	16,36
M 5	x 0.8	6.0	66.0	19.0	6.3	5,00	03608	16,36
M 6	x 1.0	7.3	72.0	22.0	8.0	6.40	03609	18,63
M 8	x 1.25	9.6	80.0	24.0	10.0	8.00	03611	22,18
M 10	x 1.5	11.9	89.0	29.0	9.0	7.10	03615	26,00
M 12	x 1.75	14.3	95.0	30.0	11.2	9.00	03620	36,35

Foro raccomandato

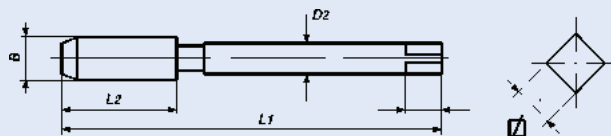
D	M 3	M 4	M 5	M 6	M 8	M 10	M 12
∅	3,4	4,6	5,6	6,8	9,0	11,2	13,4



Maschi STI (Imbocco Forma D)
 per filetti riportati tolleranza 2B
**Forma D****HSS-G****Tolleranza 3B****UNC/UNF**

Diametro Nominale D	B	L 1	L 2	D 2	∅	Articolo	Euro
UNC/NC - Passo grosso							
No. 2 x 56	2.8	48.0	10.0	3.15	2.5	03100	13,52
No. 4 x 40	3.7	53.0	13.0	4.0	3.15	03101	13,52
No. 5 x 40	4.0	53.0	13.0	4.0	3.15	03102	13,52
No. 6 x 32	4.5	58.0	16.0	5.0	4.00	03103	13,52
No. 8 x 32	5.2	62.0	17.0	5.6	4.50	03104	13,52
No. 10 x 24	6.2	66.0	19.0	6.3	5.00	03105	13,52
No. 12 x 24	6.9	66.0	19.0	7.1	5.60	03106	13,52
1/4 x 20	8.0	72.0	22.0	8.0	6.30	03107	11,55
5/16 x 18	9.8	80.0	24.0	10.0	8.00	03108	12,60
3/8 x 16	11.6	85.0	25.0	8.0	6.30	03109	13,65
7/16 x 14	13.5	95.0	30.0	11.2	9.00	03110	14,70
1/2 x 13	15.2	102.0	32.0	12.5	10.00	03111	16,28
9/16 x 12	17.0	112.0	37.0	14.0	11.20	03112	24,58
5/8 x 11	18.9	112.0	37.0	14.0	11.20	03113	30,11
3/4 x 10	22.4	118.0	38.0	16.0	12.50	03114	36,35
7/8 x 9	25.9	130.0	45.0	18.0	14.00	03115	49,25
1" x 8	29.5	138.0	48.0	20.0	16.00	03116	49,25

UNF/NF - Passo fine

No. 4 x 48	3.5	53.0	13.0	4.0	3.15	03151	14,70
No. 6 x 40	4.3	53.0	13.0	4.5	3.55	03152	14,70
No. 8 x 36	5.1	62.0	17.0	5.6	4.50	03153	14,70
No. 10 x 32	5.9	66.0	19.0	6.3	5.00	03154	14,70
1/4 x 28	7.5	69.0	19.0	8.0	6.30	03155	11,55
5/16 x 24	9.3	76.0	20.0	10.0	8.00	03156	12,60
3/8 x 24	10.9	82.0	22.0	8.0	6.30	03157	13,65
7/16 x 20	12.8	84.0	24.0	9.0	7.10	03158	14,70
1/2 x 20	14.4	90.0	25.0	11.2	9.00	03159	16,28
9/16 x 18	16.1	104.0	29.0	12.5	10.00	03160	24,58
5/8 x 18	17.7	104.0	29.0	14.0	11.20	03161	30,11
3/4 x 16	21.1	104.0	29.0	14.0	11.20	03162	36,35
7/8 x 14	24.6	120.0	35.0	18.0	14.00	03163	49,25
1" x 12	28.2	127.0	37.0	20.0	16.00	03164	49,25
1" x 14	27.8	127.0	37.0	20.0	16.00	03165	49,25

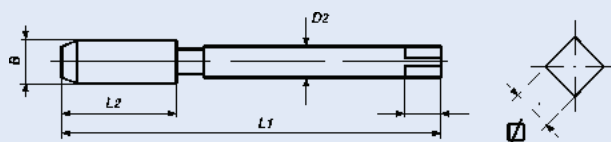

Maschi STI Set di 2 pz.
per filetti riportati tolleranza 2B



UNC/UNF

Diametro Nominale D	HSS-G		Tolleranza 3B				Articolo	Euro
	B	L 1	L 2	D 2	∅			
UNC/NC								
1.1/8 x 7	33.3	151	51	22.4	18.0	03117	155,40	
1.1/4 x 7	36.5	162	57	25.0	20.0	03118	183,75	
1.3/8 x 6	40.4	170	60	28.0	22.4	03119	231,00	
1.1/2 x 6	43.6	187	67	31.5	25.0	03120	294,00	
UNF/NF								
1.1/8 x 12	31.3	137	37	22.4	18.0	03166	155,40	
1.1/4 x 12	34.5	144	39	25.0	20.0	03167	183,75	
1.3/8 x 12	37.7	150	39	28.0	22.4	03168	231,00	
1.1/2 x 12	40.9	150	39	28.0	22.4	03169	294,00	
UNx8								
1.1/8 x 8	1.1/4	151	51	22.4	18.0	03191	166,95	
1.1/4 x 8	1.3/8	162	57	25.0	20.0	03192	194,25	
1.3/8 x 8	1.1/2	170	60	28.0	22.4	03193	246,75	
1.1/2 x 8	1.5/8	170	60	28.0	22.4	03194	327,60	
1.5/8 x 8	1.3/4	187	67	31.5	25.0	03195	346,50	
1.3/4 x 8	1.7/8	187	67	31.5	25.0	03196	499,80	
1.7/8 x 8	2"	200	70	35.5	28.0	03197	499,80	
2" x 8	2.1/8	200	70	35.5	28.0	03198	997,50	

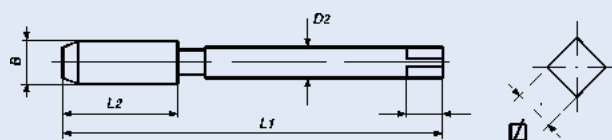

Maschi STI (Imbocco Forma D)
 per filetti riportati
**Forma D****HSS-G****BSW/BSF**

Diametro Nominale D	B	L 1	L 2	D 2	∅	Articolo	Euro
---------------------	---	-----	-----	-----	---	----------	------

BSW - Withworth - Passo grosso

1/8 x 40	3.9	53.0	13.0	4.0	3.15	03201	11,55
3/16 x 24	6.0	56.0	19.0	6.3	5.00	03202	11,55
1/4 x 20	7.8	72.0	22.0	8.0	6.30	03203	11,55
5/16 x 18	9.6	80.0	24.0	10.0	8.00	03204	12,60
3/8 x 16	11.4	85.0	25.0	8.0	6.30	03205	13,65
7/16 x 14	13.2	95.0	30.0	11.2	9.00	03206	14,70
1/2 x 12	15.2	102.0	32.0	12.5	10.00	03207	16,28
9/16 x 12	16.8	102.0	32.0	12.5	10.00	03208	24,58
5/8 x 11	18.6	112.0	37.0	14.0	11.20	03209	30,11
11/16 x 11	20.2	112.0	37.0	14.0	11.20	03210	36,35
3/4 x 10	22.0	118.0	38.0	16.0	12.50	03211	36,35
7/8 x 9	25.5	130.0	45.0	18.0	14.00	03212	49,25
1" x 8	29.1	138.0	48.0	20.0	16.00	03213	49,25

BSF - Withworth - Passo fine

3/16 x 32	5.7	66.0	19.0	6.3	5.00	03251	11,55
1/4 x 26	7.5	72.0	22.0	8.0	6.30	03253	11,55
5/16 x 22	9.3	80.0	24.0	10.0	8.00	03255	12,60
3/8 x 20	11.0	85.0	25.0	8.0	6.30	03256	13,65
7/16 x 18	12.8	89.0	29.0	9.0	7.10	03257	14,70
1/2 x 16	14.6	95.0	30.0	11.2	9.00	03258	16,28
9/16 x 16	16.2	102.0	32.0	12.5	10.00	03259	24,58
5/8 x 14	18.0	112.0	37.0	14.0	11.20	03260	30,11
11/16 x 14	19.6	112.0	37.0	14.0	11.20	03261	36,35
3/4 x 12	21.5	118.0	38.0	16.0	12.50	03262	36,35
7/8 x 11	24.9	130.0	45.0	18.0	14.00	03264	49,25
1" x 10	28.4	138.0	48.0	20.0	16.00	03265	49,25

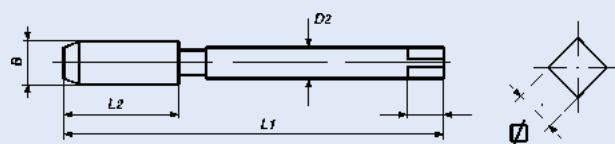

Maschi STI (Imbocco forma D) per filetti riportati

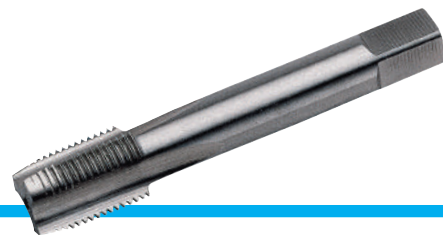

Form D

HSS-G

GAS (BSP)

Diametro Nominale D	B	L 1	L 2	D 2	Ø	Articolo	Euro
Gas (BSP)							
1/8 x 28	10.8	59.0	15.0	8.0	6.30	03301	12,60
1/4 x 19	14.7	67.0	19.0	11.2	9.00	03302	15,75
3/8 x 19	18.3	75.0	21.0	14.0	11.20	03303	21,00
1/2 x 14	23.1	87.0	26.0	16.0	12.50	03304	31,50
5/8 x 14	25.0	91.0	26.0	18.0	14.00	03305	48,30
3/4 x 14	28.6	96.0	28.0	20.0	16.00	03306	48,30
1" x 11	36.0	109.0	33.0	25.0	20.00	03307	73,50

Maschi STI Set di 2 pz. per filetti riportati



HSS-G

GAS (BSP)

Diametro Nominale D	B	L 1	L 2	D 2	Ø	Articolo	Euro
Gas (BSP)							
1/8 x 28	10.8	59	15	8.0	6.3	03311	30,45
1/4 x 19	14.7	67	19	11.2	9.0	03312	31,50
3/8 x 19	18.3	75	21	14.0	11.2	03313	40,95
1/2 x 14	23.1	87	26	16.0	12.5	03314	64,05
5/8 x 14	25.1	91	26	18.0	14.0	03315	90,30
3/4 x 14	28.6	96	28	20.0	16.0	03316	90,30
7/8 x 14	32.4	102	29	22.4	18.0	03318	142,80
1" x 11	36.0	109	33	25.0	20.0	03317	142,80

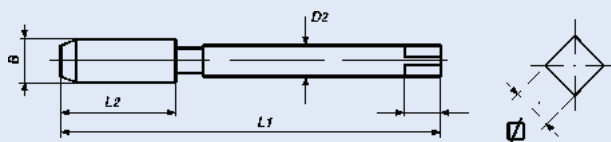

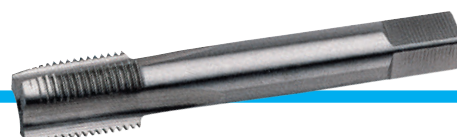
Maschi STI (Imbocco forma D)
 per filetti riportati

Form D	HSS-G						Articolo	Euro
Diametro Nominale D	B	L 1	L 2	D 2	∅			
BA								
BA 0	7.1	66.0	19.0	7.1	5.60	03321	11,55	
BA 2	5.6	66.0	19.0	6.3	5.00	03323	11,55	
BA 4	4.4	53.0	13.0	4.5	3.55	03325	11,55	
BA 6	3.4	50.0	13.0	3.55	2.80	03327	11,55	
BS. Brass								
1/4 x 26	7.5	69.0	19.0	8.0	6.30	03341	11,55	
5/16 x 26	9.1	76.0	20.0	10.0	8.00	03342	12,60	
3/8 x 26	10.7	82.0	22.0	8.0	6.30	03343	13,65	
7/16 x 26	12.3	84.0	24.0	9.0	7.10	03344	17,85	
1/2 x 26	13.9	90.0	25.0	11.2	9.00	03345	24,68	

Maschi STI V-COIL rapid
 per filetti riportati ISO 2 (6H)
 Attacco 1/4"

Passo Metrico

Form D	HSS-G				Tolleranza ISO 1 (4H)	Articolo	Euro
Diametro Nominale D	B	L 1	L 2	∅			
M 2.5 x 0.45	3.1	36.0	11.0	1/4"	03090	7,35	
M 3 x 0.5	3.6	36.0	11.0	1/4"	03091	7,35	
M 4 x 0.7	4.9	36.0	13.0	1/4"	03092	8,40	
M 5 x 0.8	6.0	36.0	16.0	1/4"	03093	8,40	
M 6 x 1.0	7.3	36.0	17.0	1/4"	03094	10,50	
M 8 x 1.25	9.6	42.0	20.0	1/4"	03095	13,65	
M 10 x 1.5	11.9	50.0	24.0	1/4"	03096	16,80	
M 12 x 1.75	14.3	50.0	29.0	1/4"	03097	17,85	

Punte STI V-COIL rapid
 Attacco 1/4"

Diametro Nominale D	L 1	L 2	∅	Articolo	Euro
2.6 mm	36.0	16.0	1/4"	03080	7,35
3.2 mm	36.0	16.0	1/4"	03081	7,35
4.2 mm	36.0	16.0	1/4"	03082	7,35
5.2 mm	46.0	26.0	1/4"	03083	7,35
6.3 mm	46.0	26.0	1/4"	03084	7,35
8.3 mm	46.0	26.0	1/4"	03085	9,45
10.4 mm	50.0	33.5	1/4"	03086	10,50
12.4 mm	50.0	33.5	1/4"	03087	12,60

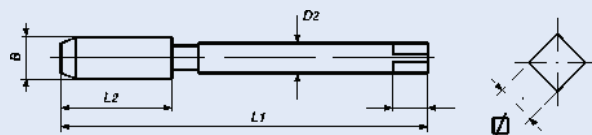

Maschi STI per candele a gradino a corto

per filetti riportati ISO 2 (6H)



Passo Metrico

HSS-G Tolleranza ISO 1 (4H)

M

Diametro Nominale D	P	B1	B2	L 3	L 2	L1	D 2	∅	Articolo	Euro
M 6	x 1.0	7.3	6	7	28	70	8	6.3	03630	17,85
M 8	x 1.25	9.6	8	9	32	75	8	6.3	03631	17,85
M 10	x 1.5	11.9	10	9	37	80	9	7.1	03632	25,20
M 10	x 1.25 NEW	11.6	10	8	30	74	8	6.3	03637	25,20
M 10	x 1.0	11.3	10	8	30	74	8	6.3	03633	25,20
M 12	x 1.25	13.6	12	9	32	75	9	7.1	03634	32,55
M 14	x 1.25	15.6	14	10	45	90	12	9.2	03635	35,70
M 18	x 1.5	20.0	18	10	47	116	16	12.5	03636	52,50

Punte da trapano STI

per Filetti Riportati

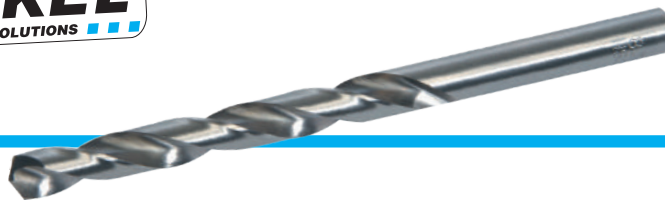

Diametro Ø	PER FILETTI	Articolo	Euro	
2.1 mm	M 2 X 0.4	VC 021	1,68	
2.4 mm		UNC 2 X 56	VC 024	1,68
2.6 mm	M 2.5 X 0.45	VC 026	2,10	
3.0 mm		UNC 4 X 40 - UNF 4 X 48	VC 030	2,10
3.2 mm	M 3 X 0.5	VC 032	2,31	
3.4 mm		UNC 5 X 40 - BSW 1/8 X 40	VC 034	2,31
3.7 mm	M 3.5 X 0.6	VC 037	2,42	
4.2 mm	M4 X 0.7	VC 042	2,73	
4.4 mm		UNC 8 X 32 - UNF 8 X 36	VC 044	2,73
4.5 mm		VC 045	2,73	
5.0 mm		BSF 3/16 X 32	VC 050	2,94
5.1 mm		UNC 10 X 24 - UNF 10 X 32 - BSW 3/16 X 24	VC 051	3,57
5.2 mm	M 5 X 0.8	VC 052	3,57	
6.0 mm		VC 060	3,99	
6.3 mm	M 6 X 1.0	VC 063	4,62	
6.6 mm		UNF 1/4 X 28 - BSW 1/4 X 26	VC 066	5,04
6.7 mm		UNC 1/4 X 20 - BSW 1/4 X 20	VC 067	5,04
7.3 mm	M 7 X 1.0	VC 073	5,67	
8.3 mm	M 8 X 1.25 - M 8 X 1.0	UNC 5/16 X 18 - BSW 5/16 X 18 - BSF 5/16 X 22	VC 083	8,82
9.3 mm	M 9 X 1.25	VC 093	8,82	
9.8 mm		UNF 3/8 X 24	VC 098	9,66
9.9 mm		UNC 3/8 X 16 - BSW 3/8 X 16 - BSF 3/8 X 20	VC 099	9,66
10.3 mm	M 10 X 1.25 - M 10 X 1.0	VC 103	12,60	
10.4 mm	M 10 X 1.5	VC 104	12,60	
11.4 mm	M 11 X 1.5	VC 114	15,96	
11.5 mm		UNF 7/16 X 20	VC 115	15,96
11.6 mm		UNC 7/16 X 14 - BSW 7/16 X 14 - BSF 7/6 X 18	VC 116	15,96
12.3 mm	M 12 X 1.25 - M 12 X 1.0	VC 123	19,95	
12.4 mm	M 12 X 1.75 - M 12 X 1.5	VC 124	19,95	
13.0 mm		UNC 1/2 X 13 - UNF 1/2 X 12 BSW 1/2 X 12 - BSF 1/2 X 16	VC 130	19,95

Diametro del foro per maschiatura V-COIL

M/MF	Ø
	mm
M 2 x 0.4	2.10
M 2.5 x 0.45	2.60
M 3 x 0.5	3.20
M 3.5 x 0.6	3.70
M 4 x 0.7	4.20
M 5 x 0.8	5.20
M 6 x 1.0	6.30
M 7 x 1.0	7.30
M 8 x 1.25	8.30
M 8 x 1.0	8.30
M 9 x 1.25	9.30
M 10 x 1.5	10.40
M 10 x 1.25	10.30
M 10 x 1.0	10.30
M 11 x 1.5	11.40
M 12 x 1.75	12.40
M 12 x 1.5	12.40
M 12 x 1.25	12.30
M 12 x 1.0	12.30
M 14 x 2.0	14.50
M 14 x 1.5	14.40
M 14 x 1.25	14.40
M 14 x 1.0	14.30
M 16 x 2.0	16.50
M 16 x 1.5	16.40
M 18 x 2.5	18.60
M 18 x 2.0	18.50
M 18 x 1.5	18.50
M 20 x 2.5	20.60
M 20 x 2.0	20.50
M 20 x 1.5	20.50
M 22 x 2.5	22.60
M 22 x 2.0	22.50
M 22 x 1.5	22.50
M 24 x 3.0	24.75
M 24 x 2.0	24.50
M 24 x 1.5	24.50
M 26 x 1.5	26.50
M 27 x 1.5	27.50
M 27 x 2.0	27.50
M 27 x 3.0	27.75
M 28 x 1.5	28.50
M 30 x 1.5	30.50
M 30 x 2.0	30.50
M 30 x 3.5	31.00
M 33 x 2.0	33.50
M 33 x 3.5	34.00
M 36 x 1.5	36.50
M 36 x 2.0	36.50
M 36 x 3.0	37.00
M 36 x 4.0	37.00

UNC	Ø
	mm
No. 2 x 56	2.4
No. 4 x 40	3.0
No. 5 x 40	3.4
No. 6 x 32	3.7
No. 8 x 32	4.4
No. 10 x 24	5.1
No. 12 x 24	5.7
1/4 x 20	6.7
5/16 x 18	8.3
3/8 x 16	9.9
7/16 x 14	11.60
1/2 x 13	13.00
9/16 x 12	14.80
5/8 x 11	16.50
3/4 x 10	19.75
7/8 x 9	23.00
1" x 8	26.25
1.1/8 x 7	29.50
1.1/4 x 7	33.00
1.3/8 x 6	36.00
1.1/2 x 6	39.50
UNF mm	
No. 4 x 48	3.0
No. 6 x 40	3.7
No. 8 x 36	4.4
No. 10 x 32	5.1
1/4 x 28	6.6
5/16 x 24	8.2
3/8 x 24	9.8
7/16 x 20	11.50
1/2 x 20	13.00
9/16 x 18	14.80
5/8 x 18	16.25
3/4 x 16	19.50
7/8 x 14	22.75
1" x 12	26.00
1.1/8 x 12	29.00
1.1/4 x 12	32.50
1.3/8 x 12	35.50
1.1/2 x 12	38.50

BSW	Ø
	mm
1/8 x 40	3.4
3/16 x 24	5.1
1/4 x 20	6.7
5/16 x 18	8.3
3/8 x 16	9.9
7/16 x 14	11.6
1/2 x 12	13.0
9/16 x 12	14.8
5/8 x 11	16.7
3/4 x 10	20.0
7/8 x 9	23.0
1" x 8	26.5
BSF mm	
3/16 x 32	5.0
1/4 x 26	6.6
5/16 x 22	8.3
3/8 x 20	9.9
7/16 x 18	11.6
1/2 x 16	13.0
9/16 x 16	14.8
5/8 x 14	16.4
3/4 x 12	19.5
7/8 x 11	22.7
1" x 10	26.5
UNx8 mm	
1.1/8 x 8	28.75
1.1/4 x 8	31.75
1.3/8 x 8	35.00
1.1/2 x 8	38.00
1.5/8 x 8	41.50
1.3/4 x 8	44.50
1.7/8 x 8	47.75
2" x 8	50.90

GAS (BSP)	Ø
	mm
1/8 x 28	10.00
1/4 x 19	13.60
3/8 x 19	17.10
1/2 x 14	21.50
5/8 x 14	23.40
3/4 x 14	27.00
7/8 x 14	30.60
1" x 11	33.70

Filetti Riportati tipo a bussola per candele acciaio inox



Diametro Nominale D	R		Articolo	Euro
M 14 x 1.25	9.5 mm	10	19136	4,52
M 14 x 1.25	11.2 mm	10	19137	4,73
M 14 x 1.25	12.7 mm	10	19138	4,73
M 14 x 1.25	17.5 mm	10	19139	5,04

Maschio SP per candele filetto M14 x 1,25







Multi-Drive HSS-G Tolleranza ISO2 (6H)

Diametro Nominale D	Tipo	L1	L2	SW1	SW2	Articolo	Euro
M 16 x 1.25	SP	70	41	16	4	19001	45,15

Assortimento Filetti Riportati tipo a bussola per candele per candele M14 x 1,25 acciaio inox



					Articolo	Euro
M 16 x 1.25	4	4	4	4	19113	76,65

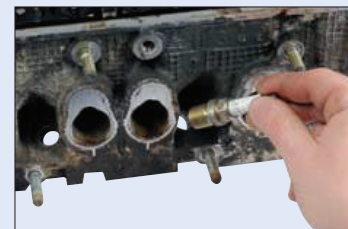

Filetti Riportati tipo a bussola per sonde lambda acciaio inox



Diametro Nominale D	R		Articolo	Euro
M 18 x 1.5	9.0 mm	10	19147	1,37

Filetti Riportati per sonde lambda inconel X750



Diametro Nominale D	R		Articolo	Euro
M 18 x 1.5	9.0 mm	10	19149	12,60

Maschio LS per filetti M18 x 1,5 dei sensori ossigeno



Multi-Drive HSS-G Tolleranza ISO2 (6H)

Diametro Nominale D	Tipo	L1	L2	SW1		Articolo	Euro
M 20 x 1.5	LS	50	21	14	1/4"	19007	38,85

Posatore LSN per filetti M18 x 1,5 dei sensori ossigeno



Multi-Drive HSS-G Tolleranza ISO2 (6H)

Diametro Nominale D	Tipo	L1	L2	SW1		Articolo	Euro
M 18 x 1.5	LS	40	27	14	1/4"	19008	28,35

Assortimento Filetti Riportati per sensore ossigeno M18 x 1.5 acciaio inox / inconel X750



				Articolo	Euro
M 18 x 1.25	M 20 x 1.5	5	5	19104	126,00

Tappi Filettati per scarico olio acciaio zincato

A





B



Diametro Nominale D	Tipo		Articolo	Euro
M 13 x 1.5	A	10	19130	3,99
M 15 x 1.5	A	10	19131	3,99
M 17 x 1.5	B	10	19132	3,99

Anelli di tenuta per tappi filettati in rame



Diametro Nominale D	 Tipo	Per tappi		Articolo	Euro
15 x 19 x 1.5 mm	Rame	M 13 x 1.5 M 15 x 1.5	25	19140	0,53
17 x 21 x 1.5 mm	Rame	M 17 x 1.5	25	19141	0,53

Mashi per tappi filettati scarico olio per filetti M18 x 1,5 dei sensori ossigeno





Multi-Drive HSS-G Tolleranza ISO2 (6H)

Diametro Nominale D	Tipo	L1	L2	SW1	SW2	Articolo	Euro
M 13 x 1.5	OS	50	21	16	4	19002	27,30
M 15 x 1.5	OS	50	21	16	4	19003	27,30
M 17 x 1.5	OS	50	21	16	5	19004	30,98

Assortimento Tappi Filettati per Tappi scarico olio Maschi, Tappi e Anelli di Tenuta



		 Rame	Articolo	Euro
M 13 x 1.5	5	10	19120	99,75
M 15 x 1.5	5	10		
M 17 x 1.5	5	10		



PRO+

KIT RIPARAZIONE TAPPO DI SCARICO OLIO

BGS articolo	DESCRIZIONE	Euro
BGS 168	M13 X 1.25	48,20
BGS 156	M13 X 1.5	47,18
BGS 151	M14 X 1.25	53,30
BGS 157	M15 X 1.5	48,45
BGS 158	M17 X 1.5	53,55
BGS 159	M20 X 1.5	54,83

CARATTERISTICHE

- ogni set comprende:
 - 1 maschio filettato HSS-G
 - 6 viti di ricambio
 - 6 anelli di tenuta in alluminio
 - 12 anelli di tenuta in rame



PRO+

CROMO

BGS articolo	DESCRIZIONE	Euro
BGS 123	SET 114 PEZZI, PER RIPARAZIONE TAPPI SCARICO OLIO	109,14

CARATTERISTICHE

- 6 maschi: M13x1,25 / M13x1,5 / M15x1,5 / M17x1,5 / M20x1,5 / M22x1,5
- 6 viti per misura: M13x1,25 / M13x1,5 / M15x1,5 / M17x1,5 / M20x1,5 / M22x1,5
- 72 rondelle in alluminio 13 - 15 - 17 - 20 - 22 mm



PRO+

BGS articolo	DESCRIZIONE	Euro
BGS 8119	ASSORTIMENTO 534 PEZZI, TAPPI SCARICO OLIO E O-RING IN ALLUMINIO	76,37

CARATTERISTICHE

- tappi scarico olio:
 - 5 pz x M10, 5 pz x M12, 5 pz x M13, 5 pz x M14, 5 pz x M15, 3 pz x M16, 3 pz x M18, 3 pz x M20
- o-ring in alluminio:
 - 50 pz x 6 mm, 50 pz x 8 mm, 50 pz x 10 mm, 50 pz x 12 mm, 50 pz x 13 mm, 50 pz x 14 mm, 50 pz x 15 mm, 50 pz x 16 mm, 50 pz x 18 mm, 50 pz x 20 mm
- in confezione in plastica



PRO+

BGS articolo	DESCRIZIONE	Euro
BGS 126	SET 64 PEZZI, PER TAPPI SCARICO OLIO	82,88

CARATTERISTICHE

- 4 pz maschi in cromo molibdeno: M13 x 1,5, M15 x 1,5, M17 x 1,5, M20 x 1,5
- 5 viti per misura: M13 x 1,5 mm, M15 x 1,5 mm, M17 x 1,5 mm, M20 x 1,5 mm
- 10 rondelle in alluminio per misura Ø: 13, 15, 17, 20 mm

RICAMBI

BGS articolo	DESCRIZIONE	Euro
BGS 126-BM13	MASCHIO M13	6,63
BGS 126-BM15	MASCHIO M15	8,16
BGS 126-BM17	MASCHIO M17	10,20
BGS 126-BM20	MASCHIO M20	11,22
BGS 126-SM13	SET 5 PZ, TAPPI SCARICO OLIO M13	4,85
BGS 126-SM15	SET 5 PZ, TAPPI SCARICO OLIO M15	6,12
BGS 126-SM17	SET 5 PZ, TAPPI SCARICO OLIO M17	7,14
BGS 126-SM20	SET 5 PZ, TAPPI SCARICO OLIO M20	8,42
BGS 126-UM13	SET 10 PZ RONDELLE IN ALLUMINIO M13	1,91
BGS 126-UM15	SET 10 PZ RONDELLE IN ALLUMINIO M15	2,17
BGS 126-UM17	SET 10 PZ RONDELLE IN ALLUMINIO M17	2,42
BGS 126-UM20	SET 10 PZ RONDELLE IN ALLUMINIO M20	2,68



PRO+

BGS articolo	DESCRIZIONE	Euro
BGS 8118	ASSORTIMENTO 534 PEZZI, VITI PER TAPPO DI SCARICO OLIO E O-RING	136,25

CARATTERISTICHE

- viti per tappo di scarico olio:
 - 5 pz x 10 mm, 5 pz x 12 mm, 5 pz x 13 mm, 5 pz x 14 mm, 5 pz x 15 mm, 3 pz x 16 mm, 3 pz x 18 mm, 3 pz x 20 mm
- o-ring in rame:
 - 50 pz x 6 mm, 50 pz x 8 mm, 50 pz x 10 mm, 50 pz x 12 mm, 50 pz x 13 mm, 50 pz x 14 mm, 50 pz x 15 mm, 50 pz x 16 mm, 50 pz x 18 mm, 50 pz x 20 mm
- in confezione in plastica



PRO+

BGS articolo	DESCRIZIONE	Euro
BGS 8132	ASSORTIMENTO 75 PEZZI, RONDELLE IN RAME, MISURE METRICHE, PER TAPPI DI SCARICO OLIO	19,25

CARATTERISTICHE

- composto da rondelle dei seguenti formati (Ø interno x Ø esterno x spessore):
 - 5,0 x 10 x 1,0 mm - 6,0 x 10 x 1,0 mm
 - 7,0 x 10 x 1,0 mm - 8,0 x 10 x 1,0 mm
 - 10,5 x 17 x 1,5 mm - 11,0 x 17 x 1,5 mm
 - 12,5 x 20 x 1,5 mm - 14,0 x 18 x 1,0 mm
 - 14,0 x 20 x 1,5 mm - 15,0 x 20 x 2,0 mm
 - 16,0 x 22 x 2,0 mm - 16,5 x 24 x 2,0 mm
 - 17,5 x 24 x 2,0 mm
- in confezione in plastica

POLLICI



PRO+

BGS articolo	DESCRIZIONE	Euro
BGS 8144	ASSORTIMENTO 75 PEZZI, ANELLI IN RAME, IN POLLICI, PER TAPPI SCARICO OLIO	20,27

CARATTERISTICHE

- idoneo per tappi di scarico olio
- 5 pz. per ciascuno dei seguenti formati:
 - 3/16" x 25/64" x 1/32"; 15/64" x 25/64" x 1/32"
 - 17/64" x 25/64" x 1/32"; 5/16" x 15/32" x 1/32"
 - 25/64" x 5/8" x 1/32"; 13/32" x 21/32" x 3/64"
 - 27/64" x 21/32" x 3/64"; 15/32" x 25/32" x 3/64"
 - 31/64" x 25/32" x 3/64"; 35/64" x 45/64" x 1/32"
 - 35/64" x 25/32" x 3/64"; 37/64" x 25/32" x 5/64"
 - 5/8" x 55/64" x 5/64"; 41/64" x 15/16" x 5/64"
 - 11/16" x 15/16" x 5/64"
- in confezione in plastica

ASSORTIMENTI RONDELLE DI RICAMBIO PER SET FER 230

FERMEC articolo	DESCRIZIONE		Euro
FER ROR1218	RONDELLA IN RAME SPESSORE 1,5 12/18	100	0,25
FER ROR1420	RONDELLA IN RAME SPESSORE 1,5 14/20	100	0,32
FER ROR1622	RONDELLA IN RAME SPESSORE 1,5 16/22	100	0,35
FER ROR1824	RONDELLA IN RAME SPESSORE 1,5 18/24	100	0,38
FER ROR2026	RONDELLA IN RAME SPESSORE 1,5 20/26	100	0,47
FER ROR2228	RONDELLA IN RAME SPESSORE 1,5 22/28	100	0,50
FER ROA1218	RONDELLA IN ALLUMINIO SPESSORE 1,5 12/18	100	0,08
FER ROA1420	RONDELLA IN ALLUMINIO SPESSORE 1,5 14/20	100	0,08
FER ROA1622	RONDELLA IN ALLUMINIO SPESSORE 1,5 16/22	100	0,09
FER ROA1824	RONDELLA IN ALLUMINIO SPESSORE 1,5 18/24	100	0,12
FER ROA2026	RONDELLA IN ALLUMINIO SPESSORE 1,5 20/26	100	0,12
FER ROA2228	RONDELLA IN ALLUMINIO SPESSORE 1,5 22/28	100	0,13
FER RR10014	RONDELLA TOROIDALE Ø 14	100	0,63
FER ROR1020	RONDELLA IN RAME 10,5x20 SPESSORE 2 PSA	100	0,60
FER RR10016	RONDELLA TOROIDALE Ø 16	100	0,82
FER RAG0014	RONDELLA ACCIAIO E GOMMA Ø 14	50	1,07
FER RAG0016	RONDELLA ACCIAIO E GOMMA Ø 16	50	1,10

art. FER ROR1218 RONDELLA RAME  SP. 1.5 12x18 PEZZI 20	art. FER ROR1420 RONDELLA RAME  SP. 1.5 14x20 PEZZI 20	art. FER ROR1622 RONDELLA RAME  SP. 1.5 16x22 PEZZI 20
art. FER ROR1824 RONDELLA RAME  SP. 1.5 18x24 PEZZI 10	art. FER ROR2026 RONDELLA RAME  SP. 1.5 20x26 PEZZI 10	art. FER ROR2228 RONDELLA RAME  SP. 1.5 22x28 PEZZI 10
art. FER ROA1218 RONDELLA ALLUMINIO  SP. 1.5 12x18 PEZZI 20	art. FER ROA1420 RONDELLA ALLUMINIO  SP. 1.5 14x20 PEZZI 20	art. FER ROA1622 RONDELLA ALLUMINIO  SP. 1.5 16x22 PEZZI 20
art. FER ROA1824 RONDELLA ALLUMINIO  SP. 1.5 18x24 PEZZI 10	art. FER ROA2026 RONDELLA ALLUMINIO  SP. 1.5 20x26 PEZZI 10	art. FER ROA2228 RONDELLA ALLUMINIO  SP. 1.5 22x28 PEZZI 10
art. FER RR10014 RONDELLA TOROIDALE Ø 14  PEZZI 10 PEUGEOT CITROEN	art. FER ROR1020 RONDELLA RAME  SP. 2 10,5x20 PEZZI 10 PEUGEOT CITROEN FORD	art. FER RR10016 RONDELLA TOROIDALE Ø 16  PEZZI 10 PEUGEOT CITROEN RENAULT
art. FER RAG0014 RONDELLA ACCIAIO E GOMMA Ø 14  PEZZI 10 FORD CITROEN		art. FER RAG0016 RONDELLA ACCIAIO E GOMMA Ø 16  PEZZI 10 RENAULT CITROEN

FERMEC articolo	DESCRIZIONE	Euro
FER 230	ASSORTIMENTO 290 PEZZI, RONDELLE PER TAPPI OLIO	89,25

CARATTERISTICHE

- le rondelle in rame e alluminio spessore mm. 1,5 vengono definite universali in quanto trovano applicazione su svariati modelli di vetture e furgoni. Per applicazione principale si intende quella conosciuta, le stesse misure e dimensioni possono essere uguali ad altre vetture
- disponibili tutti i ricambi

Bussole auto-filettanti

acciaio zincato

acciaio EN 10277 temprato e zincato



Diametro Nominale d	D	L mm		Articolo	€uro
Metrico					
M 2 x 0.4	M 4.5 x 0.5	6	10	FE02	1,05
			100	FE02 B	0,84
M 2.5 x 0.45	M 4.5 x 0.5	6	10	FE025	0,74
			100	FE025 B	0,53
M 3 x 0.5	M 5 x 0.5	6	10	FE03	0,63
			100	FE03 B	0,42
M 4 x 0.7	M 6.5 x 0.75	8	10	FE04	0,63
			100	FE04 B	0,42
M 5 x 0.8	M 8 x 1	10	10	FE05	0,74
			100	FE05 B	0,42
M 6 x 1	M 10 x 1.5	14	10	FE06	0,84
			100	FE06 B	0,53
M 8 x 1.25	M 12 x 1.5	15	10	FE08	1,04
			100	FE08 B	0,84
M 10 x 1.5	M 14 x 1.5	18	5	FE10	1,58
			100	FE10 B	1,26
M 12 x 1.75	M 16 x 1.5	22	5	FE12	2,00
			100	FE12 B	1,79
M 12 x 1.5	M 16 x 1.5	22	5	FE125	1,89
M 14 x 2	M 18 x 1.5	24	5	FE14	1,89
M 14 x 1.5	M 18 x 1.5	24	5	FE145	2,10
M 16 x 2	M 20 x 1.5	22	5	FE16	2,50

Disponibili altre misure a richiesta

Bussole auto-filettanti

acciaio INOX 1.305 (AISI 303)



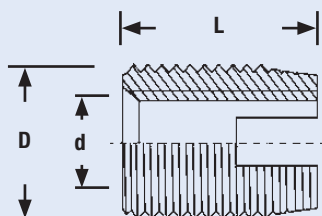

Diametro Nominale d	D	L mm		Articolo	€uro
Metrico					
M 3 x 0.5	M 5 x 0.5	6	10	FA 43	1,45
M 4 x 0.7	M 6.5 x 0.75	8	10	FA 44	1,45
M 5 x 0.8	M 8 x 1	10	10	FA 45	1,55
M 6 x 1	M 10 x 1.5	14	10	FA 46	1,55
M 8 x 1.25	M 12 x 1.5	15	10	FA 48	1,97
M 10 x 1.5	M 14 x 1.5	18	5	FA 410	2,81
M 12 x 1.75	M 16 x 1.5	22	5	FA 412	3,99



Kit bussole auto-filettanti acciaio zincato

con utensile per il montaggio a macchina con attacco 1/4" e unta HSS

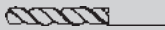



				Articolo	€uro
Metrico					
M 3 x 0.5	4.70 mm	08070	5	F003P	37,80
M 4 x 0.7	6.10 mm	08071	5	F004P	37,80
M 5 x 0.8	7.50 mm	08072	5	F005P	37,80
M 6 x 1.0	9.30 mm	08073	5	F006P	37,80
M 8 x 1.25	11.40 mm	08074	5	F008P	42,00
M 10 x 1.5	13.25 mm	08075	5	F010P	50,40
M 12 x 1.75	15.25 mm	08076	5	F012P	63,00

Kit bussole auto-filettanti acciaio zincato

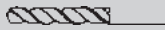

con utensile per il montaggio a macchina con attacco 1/4" e punta HSS



				Articolo	€uro
Metrico					
M5 - M12					
M 5 x 0.8	7.50 mm	08072	5	F512	180,00
M 6 x 1.0	9.30 mm	08073	5		
M 8 x 1.25	11.40 mm	08074	5		
M 10 x 1.5	13.25 mm	08075	5		
M 12 x 1.75	15.25 mm	08076	5		

Utensile per il montaggio a macchina con attacco 1/4"



Dimensions	L 1			Articolo	Euro
Metrico					
M 3 x 0.5	46	6	1/4"	08070	13,65
M 4 x 0.7	56	7	1/4"	08071	13,65
M 5 x 0.8	62	8	1/4"	08072	13,65
M 6 x 1.0	76	10	1/4"	08073	13,65
M 8 x 1.25	85	12	1/4"	08074	16,28
M 10 x 1.5	96	14	1/4"	08075	17,75
M 12 x 1.75	107	16	1/4"	08076	19,79
M 14 x 2.0			1/4"	08077	21,50

Foro raccomandato

D	M2	M2.5	M3	M4	M5	M6	M8	M10	M12	M14	M16
∅	4.20 mm	4.20 mm	4,70 mm	6.10 mm	7.50 mm	9.30 mm	11.40 mm	13.25 mm	15.25 mm	17.00 mm	19.00 mm

Chiave avvita bussole filettate attacco: 12 mm FIAM-OBER



Ø Filetto	L mm		Articolo	€uro
M 4 x 0.7	45	1	AB 300407	13,13
M 5 x 0.8	45	1	AB 300508	13,13
M 6 x 1	45	1	AB 300610	13,13
M 8 x 1	45	1	AB 300810	13,13
M 8 x 1,25	45	1	AB 308125	13,13
M 8 x 14	45	1	AB 300814	13,13
M 10 x 1.5	45	1	AB 301015	13,13

Chiave avvita bussole filettate attacco: DIN 3126 - E6,35



Ø Filetto	L mm		Articolo	€uro
M 4 x 0.7	53	1	11904	11,55
M 5 x 0.8	53	1	11905	11,55
M 6 x 1	53	1	11906	11,55
M 8 x 1,25	53	1	11908	11,55
M 10 x 1.5	53	1	11910	11,55
M 8 (5/16) x 14	53	1	11918	11,55
M 12 x 1.25	53	1	11920	11,55

Chiave avvita bussole filettate CON SGANCIO RAPIDO ANTI GRIPPAGGIO attacco: DIN 3126 - E6,35



Ø Filetto	L mm		Articolo	€uro
M 5 x 0.8	60	1	11905 AG	25,00
M 6 x 1	60	1	11906 AG	25,00
M 8 x 1,25	60	1	11908 AG	25,00
M 10 x 1.5	60	1	11910 AG	25,00
7/16"	60	1	11916 AG	25,00